



IDS Activity Report

2006-2008

International Doris Service





**INTERNATIONAL
DORIS
SERVICE**

The International DORIS Service

January 2006 – December 2008 report

G. Tavernier (1), P. Ferrage (1), H. Fagard (2), F. Lemoine (3), C. Noll (3), R. Noomen (4), J.C. Ries (5), L. Soudarin (6), J.J. Valette (6), P. Willis (7), P. Stepanek (8), M. Otten (9), S. Kuzin (10), P. Moore (11), R. Govind (12)

- (1) Centre National d'Etudes Spatiales, 18 Avenue Edouard Belin, 31401 Toulouse Cedex 9, FRANCE
- (2) Institut Géographique National, Service de la Géodesie et du Nivellement, 2 Avenue Pasteur, 94165 Saint-Mandé CEDEX, FRANCE
- (3) NASA Goddard Space Flight Center, Greenbelt, Maryland, USA
- (4) DEOS, Delft University of Technology, THE NETHERLANDS
- (5) Center for Space Research, The University of Texas, R1000, Austin, TX 78712 USA
- (6) Collecte Localisation Satellites, 8-10, rue Hermès, Parc Technologique du Canal, 31520 Ramonville Saint-Agne, FRANCE
- (7) Institut de Physique du Globe de Paris, UFR STEP / GSP Bat Lamarck Case 701175205 Paris Cedex 13 FRANCE
- (8) Geodesy Observatory Pecný, Research Institute of Geodesy, Topography and Cartography, Ondrejov 244, 25165 Prague-East, CZECH REPUBLIC
- (9) ESA/ESOC, Robert Bosch Strasse 5, 64293 Darmstadt, GERMANY

- (10) Space Geodesy Department, Institute of Astronomy, Russian Academy of Sciences
48,Pyatnitskaya St.,Moscow 119017, RUSSIA
- (11) School of Civil Engineering and Geosciences, Newcastle University, Newcastle NE1
7RU, UNITED KINGDOM
- (12) Geoscience Australia, Geospatial and Earth Monitoring Division, Dept. of Industry,
Tourism, and Resources, GPO Box 378, Canberra, ACT 2601 AUSTRALIA

This volume of reports is the International DORIS Service Report documenting the work of the IDS components between January 2006 and December 2008. The individual reports were contributed by IDS groups in the international geodetic community who constitute the permanent components of IDS.

The IDS 2006-2008 Report describes history, changes, activities and progress of the IDS. The Governing Board and Central Bureau kindly thank all IDS components that contributed to this Report.

The entire contents of this Report also appear on the IDS web site at

http://ids.cls.fr/html/report/governing_board.html

| | |
|---|-----------|
| IDS AND DORIS QUICK REFERENCE LIST | 5 |
| GLOSSARY | 8 |
| 1 INTRODUCTION | 13 |
| 2 DORIS SPECIAL ISSUE IN JOURNAL OF GEODESY | 14 |
| 3 HISTORY | 15 |
| 4 ORGANIZATION | 17 |
| 5 THE CENTRAL BUREAU: IDS INFORMATION SYSTEM | 19 |
| 5.1 WHAT AND WHERE | 19 |
| 5.2 WEB AND FTP SITES | 20 |
| 5.2.1 IDS WEB SITE | 20 |
| 5.2.2 IDS FTP SERVER | 22 |
| 5.2.3 DORIS WEB SITE | 22 |
| 5.2.4 DATA CENTERS' WEB SITES | 23 |
| 5.3 THE MAIL SYSTEM | 23 |
| 5.3.1 DORISMAIL | 23 |
| 5.3.2 DORISREPORT | 24 |
| 5.3.3 IDS ANALYSIS FORUM | 24 |
| 5.3.4 OTHER MAILING LISTS | 25 |
| 5.4 HELP TO THE USERS | 25 |
| 5.5 FUTURE PLAN | 25 |
| 6 THE NETWORK | 26 |
| 6.1 GENERAL STATUS OF THE NETWORK | 26 |
| 6.2 RENOVATION PROGRAM OF THE PERMANENT NETWORK | 27 |
| 6.3 THIRD GENERATION BEACONS DEPLOYMENT STATUS | 28 |
| 6.4 CO-LOCATIONS WITH OTHER IERS TECHNIQUES | 28 |
| 7 THE SATELLITES FITTED OUT WITH DORIS RECEIVERS | 29 |
| IDS DATA FLOW COORDINATION (2006-2008) | 33 |
| 7.1 INTRODUCTION | 33 |
| 7.2 FLOW OF IDS DATA AND PRODUCTS | 33 |
| 7.3 DORIS DATA | 35 |
| 7.4 DORIS PRODUCTS | 37 |
| 7.5 FUTURE PLANS | 38 |
| 8 IDS DATA CENTERS | 39 |
| 8.1 CRUSTAL DYNAMICS DATA INFORMATION SYSTEM (CDDIS) | 39 |
| 8.1.1 PRESENTATION | 39 |
| 8.1.2 CDDIS FUTURE PLANS | 39 |
| 8.1.3 CDDIS CONTACT | 40 |
| 8.2 IGN DORIS DATA CENTER | 40 |
| 9 IDS ANALYSIS COORDINATION | 42 |
| 9.1 ANALYSIS COORDINATION | 42 |
| 9.2 ORBIT TESTS: RESULTS OF PRELIMINARY ORBIT COMPARISONS | 46 |
| 9.3 SINEX FILE VALIDATION | 50 |
| 9.4 ANALYSIS CENTERS STATUS AS OF DECEMBER 2008 | 51 |
| 10 IDS COMBINATION | 54 |
| 10.1 ACTIVITY SUMMARY | 54 |
| 10.2 IDS VALIDATION OF SINEX | 54 |
| 10.3 CONTRIBUTION TO ITRF2008 | 56 |
| 10.4 JASON-2 | 58 |
| 10.5 FUTURE COMBINATIONS | 58 |
| 11 REPORT OF THE ESA/ESOC ANALYSIS CENTER (ESA) | 59 |
| 11.1 INTRODUCTION | 59 |
| 11.2 ITRF-2008 ACTIVITIES | 59 |

| | | |
|--------|---|----|
| 11.3 | FUTURE ACTIVITIES..... | 61 |
| 12 | REPORT OF THE GEOSCIENCE AUSTRALIA ANALYSIS CENTER (GAU)..... | 62 |
| 12.1 | INTRODUCTION: | 62 |
| 12.2 | DATA PROCESSING | 62 |
| 12.3 | ORBIT COMPARISON TESTS..... | 63 |
| 12.4 | SINEX SUBMISSIONS | 63 |
| 12.5 | BENCHMARK TESTS..... | 63 |
| 13 | REPORT OF THE GEODETICAL OBSERVATORY PECNY ANALYSIS CENTER (GOP) | 64 |
| 13.1 | INTRODUCTION..... | 64 |
| 13.2 | ANALYSIS STRATEGY AND MODELS | 64 |
| 13.3 | AUTOMATION | 65 |
| 13.4 | RESULTS AND PRODUCTS | 65 |
| 14 | REPORT OF THE NASA/GSFC ANALYSIS CENTER (GSC)..... | 67 |
| 14.1 | ITRF2005 & SAA MODEL TESTING AND VALIDATION..... | 67 |
| 14.2 | MODEL IMPROVEMENTS FOR ALTIMETER SATELLITE POD..... | 68 |
| 14.3 | DEFINITION OF AN OPTIMAL ANALYSIS STRATEGY FOR DORIS PROCESSING..... | 69 |
| 14.4 | OTHER ANALYSIS CENTER ACTIVITIES IN 2008 | 73 |
| 15 | REPORT OF THE IGN/JPL ANALYSIS CENTER (IGN) | 74 |
| 15.1 | CONTEXT | 74 |
| 15.2 | PRODUCTS DELIVERED (2006-2008)..... | 74 |
| 15.3 | MAJOR IMPROVEMENTS | 76 |
| 16 | REPORT OF THE INASAN ANALYSIS CENTER (INA)..... | 77 |
| 16.1 | INTRODUCTION..... | 77 |
| 16.2 | PRODUCT AND ANALYSIS RESULTS DESCRIPTIONS..... | 78 |
| 17 | REPORT OF THE CNES/CLS ANALYSIS CENTER (LCA) | 80 |
| 17.1 | CONTEXT | 80 |
| 17.2 | DATA PROCESSING | 80 |
| 17.3 | PRODUCTS DELIVERED TO IDS..... | 82 |
| 17.3.1 | WEEKLY SINEX..... | 82 |
| 17.3.2 | WEEKLY COORDINATE TIME SERIES | 83 |
| 17.3.3 | ORBITS..... | 83 |
| 18 | REPORT OF THE NEWCASTLE UNIVERSITY ANALYSIS CENTER (NCL)..... | 84 |
| 19 | REFERENCES | 85 |
| 20 | PUBLICATIONS (2006-2008)..... | 87 |
| | APPENDIX: DORIS STATIONS COLOCATION WITH TIDE GAUGES | 90 |

IDS AND DORIS QUICK REFERENCE LIST

1. IDS web site

<http://ids.cls.fr/>

2. Contacts

Central Bureau IDS.central.bureau@cls.fr

Governing Board IDS.governing.board@cls.fr

3. Data Centers

CDDIS: <ftp://cddis.gsfc.nasa.gov/doris/>

IGN: <ftp://doris.ensg.ign.fr/pub/doris/>

4. DORISmail

The DORIS mail service is used to send information of general interest to the DORIS community. To send a DORISmail, use the following address: dorismail@cls.fr

5. IDS Analysis forum

The IDS Analysis Forum is a list for discussion of DORIS data analysis topics. To start a discussion on a specific topic, use the following address: ids.analysis.forum@cls.fr

6. List of documents and links to discover the DORIS system

http://ids.cls.fr/html/analysis_coord/documents.html

7. Citation

The following article is suggested for citation in papers and presentations that rely on DORIS data and results:

Tavernier, G.; Fagard, H.; Feissel-Vernier, M.; Le Bail, K.; Lemoine, F.; Noll, C.; Noomen, R.; Ries, J.C.; Soudarin, L.; Valette, J.J.; Willis, P. 2006. The International DORIS Service: genesis and early achievements, in DORIS Special Issue, P. Willis (Ed.), JOURNAL OF GEODESY 80(8-11):403-417, DOI: [10.1007/s00190-006-0082-4](https://doi.org/10.1007/s00190-006-0082-4)

8. List of DORIS publications in international peer-reviewed journals

http://ids.cls.fr/html/report/peer-reviewed_journals.html

9. Overview of the satellite constellation

<http://www.aviso.oceanobs.com/en/doris/doris-applications/index.html>

10. Sitelogs

DORIS stations description forms and pictures from the DORIS installation and maintenance department:

<http://ids.cls.fr/html/doris/sitelog.php3>

11. Virtual tour of the DORIS network with Google Earth

Download the file at <http://ids.cls.fr/html/doris/googleearth.html> and visit the DORIS sites all around the world.

12. More contacts

For particular requests, you may also contact the following persons:

Governing Board

Pascal Willis

Institut de Physique du Globe de Paris
UFR STEP / GSP Bat Lamarck Case 7011
75205 Paris Cedex 13
France
Phone: +33 (0)1 57 27 84 81
E-mail: willis@ipgp.jussieu.fr

Central Bureau

Laurent Soudarin

CLS
8-10 rue Hermes
Parc Technologique du Canal
31526 Ramonville CEDEX
France
Phone: +33 (0)5 61 39 48 49 / 5 61 39 47 50
E-mail: Laurent.Soudarin@cls.fr

Pascale Ferrage

CNES DCT/ME/OT
18, avenue Edouard Belin
31401 Toulouse CEDEX 9
France
Phone : +33 (0)5 61 28 30 66
E-mail: pascale.ferrage@cnes.fr

Analysis Coordination

Frank Lemoine

Code 698, Planetary Geodynamics,
NASA GSFC, Greenbelt
Maryland 20771
USA
Phone: (301) 614-6109
E-mail: Frank.G.Lemoine@nasa.gov

CDDIS Data Center

Carey Noll

NASA Goddard Space Flight Center
Code 920.1 Greenbelt, MD 20771
USA
Phone: +1 (301) 614-6542
E-mail: Carey.Noll@nasa.gov

IGN Data Center

Bruno Garayt

Institut Géographique National

IGN

2-4 avenue Pasteur

94165 Saint-Mandé Cedex

France

Phone: +33 (0)1 43 98 81 97

E-mail: Bruno.Garayt@ign.fr

Network

Fagard Hervé (up to 2009)

IGN

94165 Saint-Mandé CEDEX

France

Phone : + 33 1 43 98 81 48

E-mail: hervé.fagard@ign.fr

Saunier Jérôme (since 2009)

IGN

94 165 SAINT MANDE Cedex

France

Phone : +33 1 43 98 83 63

E-mail : jerome.saunier@ign.fr

GLOSSARY

AC

Analysis Center

AGU

American Geophysical Union. AGU is a scientific society that aims to advance the understanding of Earth and space. AGU conducts meetings and conferences, publishes journals, books and a weekly newspaper, and sponsors a variety of educational and public information programs.

AVISO

Archiving, Validation and Interpretation of Satellite Oceanographic data. AVISO distributes satellite altimetry data from TOPEX/Poseidon, Jason-1, ERS-1 and ERS-2, and ENVISAT, and DORIS precise orbit determination and positioning products.

AWG

Analysis Working Group

CB

Central Bureau

CDDIS

Crustal Dynamics Data Information System

CLS

Collecte Localisation Satellites. Founded in 1986, CLS is a subsidiary of CNES and Ifremer, specializes in satellite-based data collection, location and ocean observations by satellite.

CNES

Centre National d'Etudes Spatiales. The Centre National d'Etudes Spatiales is the French national space agency, founded in 1961.

CNRS

Centre National de la Recherche Scientifique. The Centre National de la Recherche Scientifique is the leading research organization in France covering all the scientific, technological and societal fields

CryoSat-2

Altimetry satellite built by the European Space Agency scheduled for launch in late 2009. The mission will determine the variations in the thickness of the Earth's continental ice sheets and marine ice cover.

CSR

Center for Space Research, the University of Texas

CSTG

Coordination of Space Technique in Geodesy

DC

Data Center

DGXX

DORIS receiver name (3rd Generation)

DIODE

Détermination Immédiate d'Orbite par DORIS Embarqué. Real-time onboard DORIS system to compute orbit.

DORIS

Doppler Orbitography and Radiopositioning Integrated by Satellite. Precise orbit determination and location system using Doppler shift measurement techniques. A global network of orbitography beacons has been deployed. DORIS was developed by CNES, the French space agency, and is operated by CLS.

EGU

European Geophysical Union

EOP

Earth Orientation Parameters

ENVISAT

ENVironmental SATellite Earth-observing satellite (ESA)

ESA

European Space Agency. The European Space Agency is a space agency founded in 1975. It is responsible of space projects for 17 European countries.

ESA, esa

acronyms for *ESA/ESOC* Analysis Center, Germany

ESOC

European Space Operation Centre (ESA, Germany)

EU

European Union

EUMETSAT

EUropean organisation for the exploitation of METeorological SATellites

GAU, gau

acronyms for the *Geoscience Australia* Analysis Center, Australia

GB

Governing Board

GDR-B, GDR-C

Versions B and C of **Geophysical Data Record**

geoc

Specific format for geodetic product: time series files of coordinates of the TRF origin (geocenter)

eop

Specific format for geodetic product: time series files of Earth orientation parameters (EOP)

GGOS

Global Geodetic Observing System

GNSS

Global Navigation Satellite System

GLONASS

Global Navigation Satellite System (Russian system)

GOP, gop

acronyms for the *Geodetic Observatory of Pecny* Analysis Center, Czech Republic

GRGS

Groupe de Recherche de Géodésie Spatiale

GSC, gsc

acronyms for the *NASA/GSFC* Analysis Center, USA

GSFC

Goddard Space Flight Center (NASA).

HY-2

(HaiYang means 'ocean' in chinese) is a marine remote sensing satellite series planned by China in 2009 (HY-2A, HY-2B (2012), HY-2C (2015), HY-2D (2019)).

IAG

International Association of Geodesy

IDS

International DORIS Service

IERS

International Earth rotation and Reference systems Service

IGN

Institut Géographique National, French National Geographical Institute

IGN, ign

acronyms for *IGN/IPGP* Analysis Center, France

IGS

International GNSS Service.

ILRS

International Laser Ranging System

INA, ina

Acronyms for the *INASAN* Analysis Center, Russia

INASAN

Institute of Astronomy, Russian Academy of Sciences

IPGP

Institut de Physique du Globe de Paris

ITRF

International Terrestrial Reference Frame

IUGG

International Union of Geodesy and Geophysics

IVS

International VLBI Service for Geodesy and Astrometry

Jason

Altimetric missions, Altimetric missions (CNES/NASA), follow-on of TOPEX/Poseidon. Jason-1 was launched on December 7, 2001 and Jason-2 was launched on June 20, 2008.

JOG

Journal Of Geodesy.

JASR

Journal of Advances in Space Research.

LCA, lca

acronyms for the *CNES/CLS* Analysis Center, France (previously *LEGOS/CLS* Analysis Center)

LEGOS

Laboratoire d'Etudes en Géodésie et Océanographie Spatiales, France

LRA

Laser Retroreflector Array. One of three positioning systems on TOPEX/Poseidon and Jason. The LRA uses a laser beam to determine the satellite's position by measuring the round-trip time between the satellite and Earth to calculate the range.

MOE

Medium Orbit Ephemeris.

NASA

National Aeronautics and Space Administration. The National Aeronautics and Space Administration is the space agency of the United States, established in 1958.

NLC, ncl

acronyms for *University of Newcastle* Analysis Center, UK

OSTST

Ocean Surface Topography Science Team

POD

Precise Orbit Determination.

POE

Precise Orbit Ephemeris.

Poseidon

One of the two altimeters onboard TOPEX/Poseidon (CNES); Poseidon-2 is the Jason-1 altimeter.

RINEX

Receiver Independent Exchange. Specific format for DORIS raw data files, based on the GPS-dedicated format

RMS

Root Mean Square

SAA

South Atlantic Anomaly

SARAL

Satellite with ARgos and Altika

SINEX

Solution (software/technique) Independent Exchange. Specific format for files of geodetic products

SLR

Satellite Laser Ranging.

snx

see SINEX

SOD

Service d'Orbitographie DORIS (CNES).

SPOT

Système Pour l'Observation de la Terre. Series of photographic remote-sensing satellites launched by the CNES.

sp1, sp3

Specific format for orbit ephemeris files

SSALTO

Segment Sol multimissions d'ALTimétrie, d'Orbitographie et de localisation précise. The SSALTO multimission ground segment encompasses ground support facilities for controlling the DORIS and Poseidon instruments, for processing data from DORIS and the TOPEX/Poseidon, Jason-1 and ENVISAT-1 altimeters, and for providing user services and expert altimetry support

STCD

STation Coordinates Difference. Specific format for time serie files of station coordinates (geodetic product)

SWOT

Surface Water Ocean Topography. Name of a future CNES/NASA satellite mission.

TBC

To Be Confirmed.

TOPEX/Poseidon

Altimetric satellite (NASA/CNES).

USO

Ultra-Stable Oscillator

UTC

Coordinated Universal Time. Timekeeping system that relies on atomic clocks to provide accurate measurements of the second, while remaining coordinated with the Earth's rotation, which is much more irregular. To stay synchronized, UTC has to be adjusted every so often by adding one second to the day, called a leap second, usually between June 30 and July 1, or between December 31 and January 1. This is achieved by counting 23h59'59", 23h59'60" then 00h00'00". This correction means that the Sun is always at its zenith at noon exactly (accurate to the second).

VLBI

Very Long Baseline Interferometry.

1 INTRODUCTION

As other space-techniques already organized into services: the International GNSS Service (IGS) for GPS, GLONASS and, in the future, Galileo (*Beutler et al. 1999*), the International Laser Ranging Service (ILRS) for both satellite laser ranging and lunar laser ranging (*Pearlman et al. 2002*) and the International VLBI Service for Geodesy and Astrometry (IVS) for geodetic radio-interferometry (*Schlueter et al. 2002*), IDS was created in 2003 as an IAG service to federate the research and developments related to the DORIS technique, to organize the expected DORIS contribution to IERS and GGOS (*Rummel et al. 2005; Willis et al. 2005*), and to foster a larger international cooperation on this topic.

At present, more than 50 groups from 35 different countries participate in the IDS at various levels, including 43 groups hosting DORIS stations in 32 countries all around the globe.

Two analysis centers contributed as individual DORIS solutions to ITRF2005 and in 2006 four analysis centers provided results for IDS. Since 2008, eight analysis groups have provided results, such as orbit solutions, weekly or monthly station coordinates, geocenter variations or Earth polar motion, that are used to generate IDS combined products for geodesy or geodynamics. All these centers have agreed to provide SINEX solutions for inclusion in the IDS combined solution that will be submitted to the IERS for ITRF2008.

2 DORIS SPECIAL ISSUE IN JOURNAL OF GEODESY

A DORIS Special Issue was organized and published in 2006 in the Journal of Geodesy, Springer-Verlag (J. Geod., 80(8-11), 406-664, 2006).

Following a broad call for participation, 17 original manuscripts were submitted and 16 were accepted following a standard review process, with at least 3 independent reviewers, with Pascal Willis as Guest Editor. The papers in the special issue demonstrate significant international cooperation, with 12 different institutions involved through the first authors, and a total of 23 institutions involved from 7 different countries, when all co-authors are considered: France (28); USA (13); UK (1); The Netherlands (1); Czech Republic (1); Switzerland (1); and Nepal (1).

All major aspects related to the DORIS system were covered: International DORIS Service organization and history, DORIS system evolutions, new satellite missions, clocks and corrections, geodetic and geophysical applications, including positioning, terrestrial reference frame, plate tectonics, Earth's rotation, ionosphere studies as well as more regional investigations in the Himalaya and in Africa.

The idea of a technique-oriented Special Issue was later used by the International GNSS Service (IGS) and the International VLBI Service (IVS). A future issue is already planned for the International Laser Ranging System (ILRS). In 2009, a second DORIS Special Issue is planned to appear in Advances in Space Research (Elsevier).

3 HISTORY

The DORIS system was designed and developed by CNES, the French space agency, in partnership with the space geodesy research institute GRGS and France's mapping and survey agency IGN for precise orbit determination of altimeter missions and consequently also for geodetic ground station positioning (*Tavernier et al. 2003*).

DORIS joined the GPS, SLR and VLBI techniques as a contributor to the IERS in the framework of ITRF-94. In order to collect, merge, analyze, archive and distribute observation data sets and products, the IGS was established and recognized as a scientific service of the IAG in 1994, followed by the ILRS in 1998 and the IVS in 1999. It is clear that DORIS has benefited from the experience gained by these earlier services.

There was an increasing demand in the late nineties among the international scientific community, particularly the IAG and the IERS, for a similar service dedicated to the DORIS technique.

On the occasion of the CSTG (Coordination of Space Technique in Geodesy) and IERS Directing Board meetings, held during the IUGG General Assembly in Birmingham in July 1999, it was decided to initiate a DORIS Pilot Experiment (*Tavernier et al. 2002*) that could lead on the long-term to the establishment of such an IDS. A joint CSTG/IERS Call for Participation in the DORIS Pilot Experiment was issued on 10 September 1999. An international network of 54 tracking stations was then contributing to the system and 11 proposals for new DORIS stations were submitted. Ten proposals were submitted for Analysis Centers (AC's). Two Global Data Centers (NASA/CDDIS in USA and IGN/LAREG in France) already archived DORIS measurements and were ready to archive IDS products. The Central Bureau was established at the CNES Toulouse Centre, as a joint initiative between CNES, CLS (Collecte Localisation Satellites) and IGN (Institut Géographique National).

The IDS Central Bureau and the Analysis Coordinator initiated several Analysis Campaigns.

Several meetings were organized in the framework of the DORIS Pilot Experiment:

- DORIS Days were held in Toulouse in May 2000 (see programme and contributions in http://ids.cls.fr/html/report/doris_days_2000/programme.html),
- an IDS Workshop was held in Biarritz in June 2002 (see programme and contributions in <http://lareg.ensg.ign.fr/IDS/events/biarritz.html>),
- an IDS Analysis Workshop was held in Marne La Vallée in February 2003 (see programme and contributions in http://lareg.ensg.ign.fr/IDS/events/prog_2003.html).

The IDS was officially inaugurated on July 1, 2003 as an IAG Service after the approval of the IAG Executive Committee at the IUGG General Assembly in Sapporo.

- The first IDS Governing Board meeting was held on November 18, 2003 in Arles, France.
- An IDS plenary meeting was held in Paris in May 2004 (see programme and contributions in http://ids.cls.fr/html/report/ids_meeting_2004/programme.html).
- An IDS workshop was held in Venice in March 2006 (see http://ids.cls.fr/html/report/ids_workshop_2006/).
- Two DORIS analysis Working Group Meetings were held in Paris in March and June 2008 (see <http://ids.cls.fr/html/report/meetings/AWG200803.html> and <http://ids.cls.fr/html/report/meetings/AWG200806.html>).
- An IDS workshop was held in Nice in November 2008 (see http://ids.cls.fr/html/report/ids_workshop_2008/).

4 ORGANIZATION

The IDS organization is similar to the organization of other IAG and IERS Services.

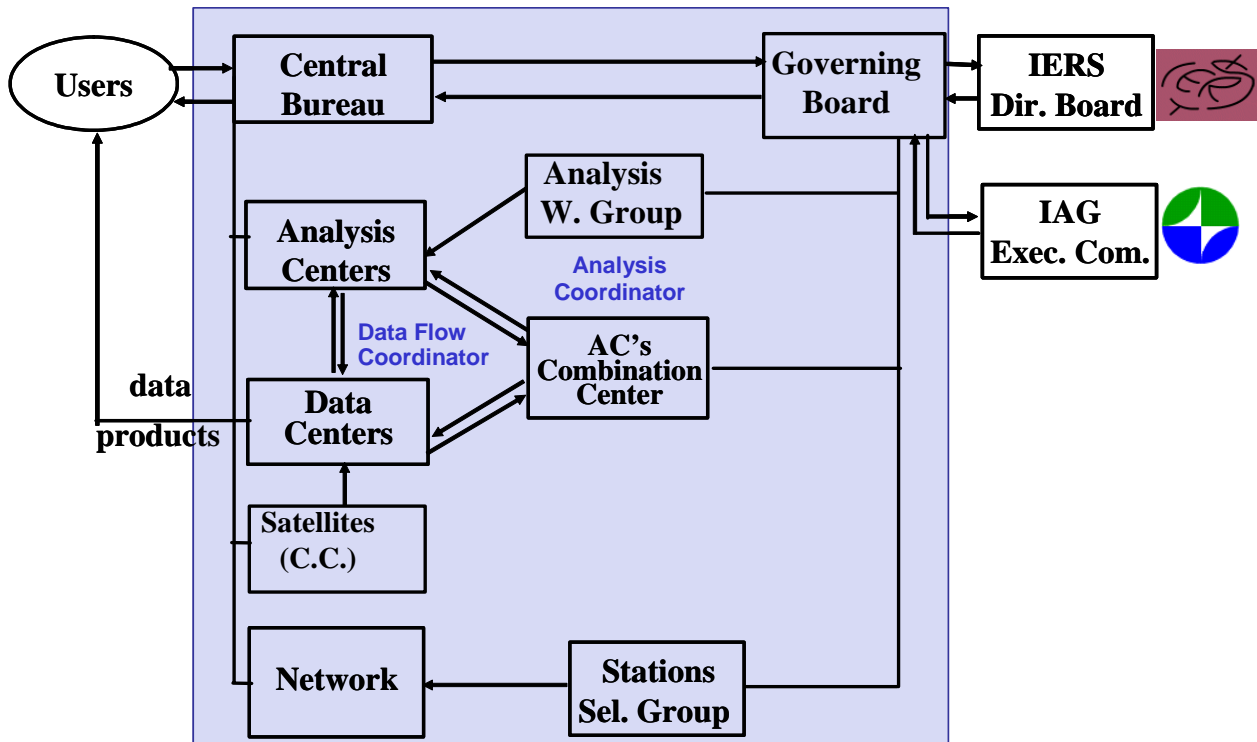

Figure 1 IDS organization

Governing Board

In December 2008, Gilles Tavernier left the IDS for other activities in CNES, and left the function of Governing Board Chair. The IDS governing board and Central Bureau would like to friendly and warmly thank Gilles Tavernier for his most valuable contribution to the IDS creation and development as the first IDS Governing Board chairperson.

Until the end of 2008, the Governing Board was:

| | | |
|------------------|------------|--------------------------------|
| Gilles Tavernier | CNES | Chairperson |
| Pascal Willis | IGN / IPGP | Analysis Center representative |
| Hervé Fagard | IGN | Network representative |
| Frank Lemoine | NASA GSFC | Analysis coordinator |
| Carey Noll | NASA GSFC | Data Flow coordinator |
| Ron Noomen | Delft UT | Representative of the IERS |
| John Ries | UTEX CSR | Member at large |
| Laurent Soudarin | CLS | Director of the Central Bureau |

A new Governing Board was elected in December 2008:

| | | |
|------------------|------------|--|
| Pascal Willis | IGN / IPGP | Chairperson and Analysis Center representative |
| Hervé Fagard | IGN | Network representative |
| Pascale Ferrage | CNES | Member at large |
| Frank Lemoine | NASA GSFC | Analysis coordinator |
| Carey Noll | NASA GSFC | Data Flow coordinator |
| Michiel Otten | ESA/ESOC | Representative of IAG |
| John Ries | UTEX CSR | Member at large |
| Laurent Soudarin | CLS | Director of the Central Bureau |
| TBD | TBD | Representative of IERS |

Central Bureau

The central bureau is made up of the following persons:

| | | |
|----------------------|----------------------------|----------|
| Laurent Soudarin | CLS | Director |
| Hervé Fagard | IGN | |
| Pascale Ferrage | CNES (since October 2008) | |
| Gilles Tavernier | CNES (until December 2008) | |
| Jean-Jacques Valette | CLS | |
| Pascal Willis | IGN / IPGP | |

5 THE CENTRAL BUREAU: IDS INFORMATION SYSTEM

Laurent Soudarin (1)

(1) CLS, France

Within the IDS, the information is provided through the web and ftp sites of the Central Bureau, the Data Centers and the Analysis Coordination, depending on the kind of information. Day-to-day news of general interest is given to the DORIS community through the DORISMAIL service. The DORIS REPORT and the IDS ANALYSIS FORUM mailing lists are devoted to specific data or product reports, or to a discussion of analysis-related issues. This report gives an overview of the IDS information system.

5.1 WHAT AND WHERE

IDS has three data/information centers:

- CB: the Central Bureau web and ftp sites at CLS
- DC: the Data Center(s): * CDDIS: web and ftp sites * IGN: ftp site
- AC: the Analysis Coordinator web pages on the CB web site

The baseline storage rules are as follows:

DC store observational data and products + formats and analysis descriptions.

CB produces/stores/maintains basic information on the DORIS system, including various standard models (satellites, receivers, signal, reference frames, etc). .

AC refers to CB and DC information on the data and modelling, and generates/stores analyses of the products.

Two criteria are considered for deciding where files are to be stored/maintained:

1. the responsibility of their content and updating,
2. the ease of user access.

Data-directed software is stored and maintained at the CB; analysis-directed software is stored/maintained, or made accessible through the AC web pages.

To avoid information inconsistencies, duplication is minimized. Logical links and cross referencing between the three types of information centers is systematically used.

5.2 WEB AND FTP SITES

5.2.1 IDS WEB SITE

address : <http://ids.cls.fr>

The IDS web site gives general information on the Service, provides access to the DORIS system pages on the AVISO web site, and hosts the Analysis Coordination pages.

The organization of the site was improved in early 2007, making it easier to access and use its contents, and numerous new materials were added. Besides the brand new dedicated pages to the Analysis Coordination, here are some of the novelties:

- The site logs of the DORIS stations are now only hosted on the IDS website.
- The DORIS bibliography was completed with DOIs (Digital Object Identifier), which makes it possible to obtain the abstract (or the full paper if the user has registered for the particular journal).
- Statistics plots of RMS of fit and number of DORIS measurements (in aggregate and by station) are routinely updated using the orbit determination analysis of the CNES POD group using the CNES Medium (MOE) and Precise Orbit Ephemeris (POE) products.
- The presentations of the IDS meetings are now all grouped on the IDS website.
- The time series was upgraded with plots and STCD of the INASAN Analysis Center.
- A kml file was created to make the virtual tour of the DORIS network with Google Earth.

The site is composed of three sections:

- “**IDS**” describes the organization of the service and includes documents, access to the data and products, event announcements, contacts and links.
- “**DORIS**” which provides a general description of the system, and gives information about the system events and the tracking network.
- “**Analysis Coordination**” which provides information and discussion areas about the analysis strategies and models used in the IDS products. It is maintained by the Analysis Coordinator with the support of the Central Bureau.

The IDS web site is supplemented by a site index, FAQs, news on the IDS and news on DORIS.

The main headings of the “**IDS**” section are:

- Organization: structure of the service, terms of reference, components
- Data and Products: information and data center organization, access information to the IDS Data Centers and to the Central Bureau ftp site.

- Meetings: calendars of the meetings organized by IDS or relevant for IDS, as well as links to calendars of other international services and organizations .
- Reports and Mails: IDS documents, DORIS bibliography, meeting presentations, DORIS-related peer-reviewed publications, mail system messages, citation rules, etc.
- Contacts and links: information about related activities

The headings of the “**DORIS**” section are:

- Official website: a description of the DORIS system on the AVISO web site
- Network: Site logs, station coordinate time series, maps, network on Google Earth.
- System monitoring: DORIS system events file, station performance plots from the CNES MOE and POE processing

The headings of the “**Analysis Coordination**” section are:

- Documents: about the DORIS system’s components (space segment, ground segment, stations, observations), the models used for the analysis, the products and their availability.
- DORIS related events: history of the workshops, meetings, analysis campaigns...
- Discussion: archive of the discussions before the opening of the forum.
- Software: a few software programs provided by the Analysis Coordinator.

This site is maintained by the Central Bureau.

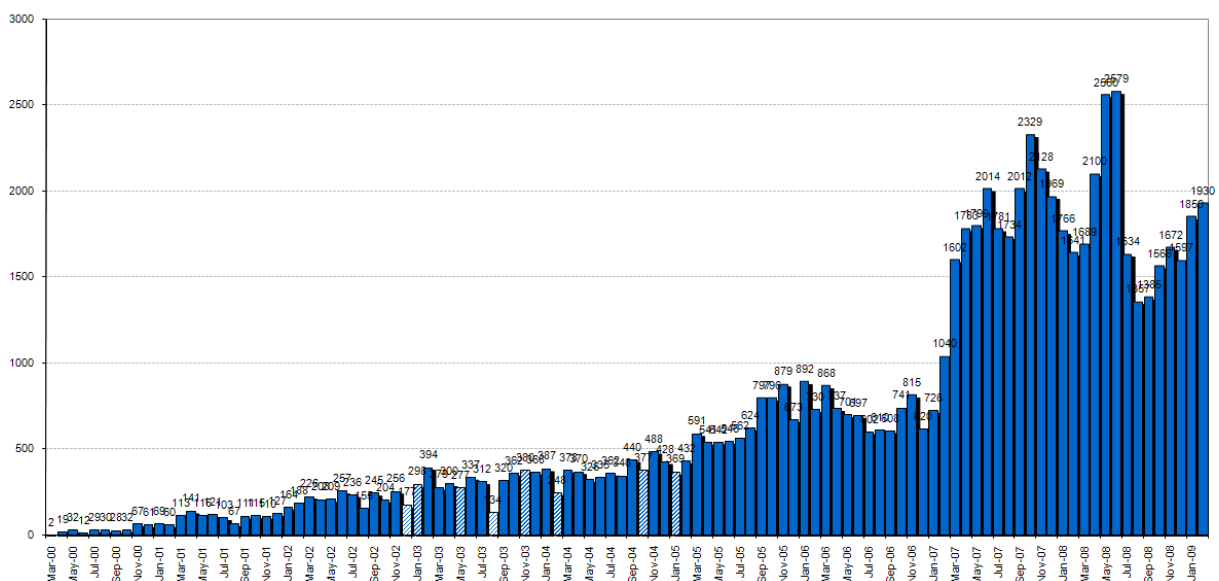

Figure 2 IDS web site number of access per month (CNES and CLS excluded)

5.2.2 IDS FTP SERVER

address: <ftp://ftp.cls.fr/pub/ids>

The IDS ftp server gives information on the DORIS system, and provides analysis results from the Analysis Coordination's combination center.

The documents available concern:

- the centers: presentation and analysis strategy of the AC's.
- the data: format description 1.0,2.1, 2.2, and RINEX, POE configuration for GDR-B and GDR-C altimetry products from Jason-1 and ENVISAT, on-board programming and POE pre-processing history.
- the DORIS-mails and DORIS-reports: archive of the messages in text format, and indexes
- the products: format of eop, geoc, iono, snx, sp1, sp3, stcd
- the satellites: macromodels, nominal attitude model, center of mass and center of gravity history, maneuver history, instrument modelling, corrective model of DORIS/Jason-1 USO frequency, plots of the POE statistics of all the stations for each satellite.
- the stations: ties, seismic events around the DORIS station network, ITRF2000, antennas description, beacon RF characteristics, information about the frequency shifts of the 3rd generation beacon, IDS recommendations for ITRF2005, Jason and Spot-4 visibility, station events, plots of the POE statistics of all the satellites for each station.
- the combinations: analysis results from Analysis Coordination's combination center (internal validation of each individual Analysis Center time series, weekly combination), IDS combination for the DORIS contribution to ITRF2008.

This site is maintained by the Central Bureau.

There is a mirror site at CDDIS: ftp://cddis.gsfc.nasa.gov/pub/doris/cb_mirror/

and at IGN: ftp://doris.ensg.ign.fr/pub/doris/cb_mirror/

5.2.3 DORIS WEB SITE

Address: <http://www.avisooceanobs.com/en/doris/index.html>

The official DORIS web site is hosted by the AVISO website which is dedicated to altimetry, orbitography and precise location missions. The DORIS pages present the principle of the system, its description (instruments onboard, ground beacons, control and processing center, system evolutions, Diode navigator), the applications and the missions.

This site is maintained by the AVISO webmaster with the support of the IDS Central Bureau.

5.2.4 DATA CENTERS' WEB SITES

Data and products, formats and analysis descriptions are stored at the CDDIS and IGN Data Centers. A detailed description is given in the report of the Data flow Coordinator.

Address of the CDDIS web site: http://cddis.gsfc.nasa.gov/doris_summary.html

Address of the CDDIS ftp site: <ftp://cddis.gsfc.nasa.gov/pub/doris/>

Address of the IGN ftp site: <ftp://doris.ensg.ign.fr/pub/doris/>

5.3 THE MAIL SYSTEM

In May 1996, as part of the IERS DORIS Coordination activities, the IGN set up the DORISMail service to disseminate general information to a large audience (this is analogous to SLRMail, IGSMail and IVSMail). This mailing list has become then one of the communication tools of the IDS. In October 2004, two new lists were created, : the DORISReport and the IDS Analysis Forum. The mails of these three lists are all archived on the mailing list server of CLS. Back-up archives of the text files are also available on the Central Bureau ftp server for the DORIS-mails and the DORISReports.

A description of the mailing lists can be found on the IDS web site on the page: http://ids.cls.fr/html/report/doris_mails.html

Dedicated mailing lists were also created for the Central Bureau, the Governing Board and the Analysis Working Group, but without archive system.

5.3.1 DORISMAIL

e-mail: dorismail@cls.fr (replacing the original dorismail@ensg.ign.fr)

The DORIS-mails are used to distribute messages of general interest to the users' community (subscribers). The messages concern:

- Network evolution: installation, renovation...
- Data delivery: lack of data, maneuver files
- Satellite status
- Status of the Data Centers
- Meeting announcements
- Calls for participation
- delivery by Analysis Centers
- etc...

The messages are moderated by the Central Bureau.

They are all archived on the mailing list server of CLS at the following address:

They are also available in text format on the IDS ftp site:

<ftp://ftp.cls.fr/pub/ids/dorismail/>

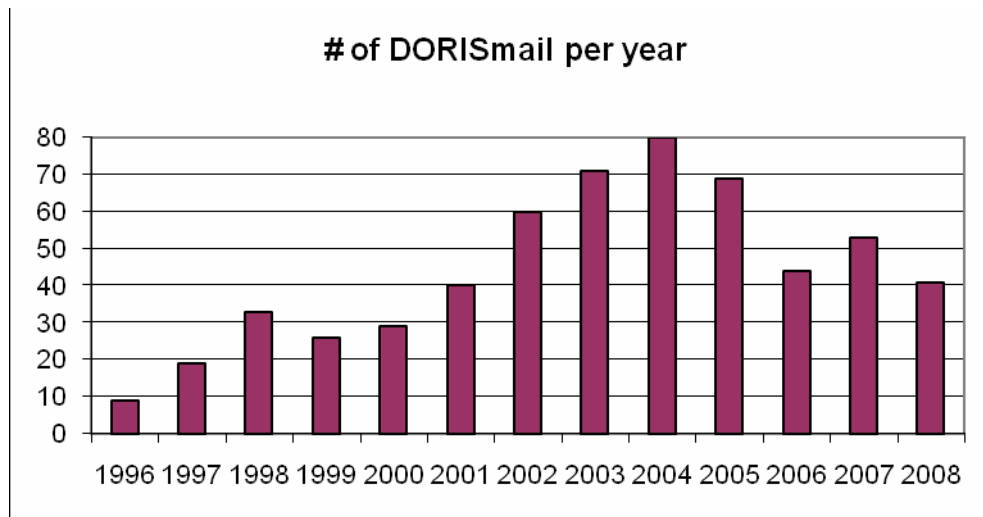

Figure 3 572 DORISMAILS were distributed between May 1996 and December 2008

5.3.2 DORISREPORT

e-mail : dorisreport@cls.fr

This list is used for regular reports from Analysis Centers, from the Analysis coordination and from the CNES POD team. The DORISReport distribution list is composed by Analysis Centers, Data Centers, IDS Governing Board and Central Bureau, CNES POD personnel who deliver data to the Data Centers.

The DORISReports are all archived on the mailing list server of CLS at the following address:

<http://listes.cls.fr/www/arc/dorisreport>

They are also available in text format on the IDS ftp site:

<ftp://ftp.cls.fr/pub/ids/dorisreport/>

The list is moderated by the Central Bureau and the CNES POD team personnel.

5.3.3 IDS ANALYSIS FORUM

e-mail : ids.analysis.forum@cls.fr

The purpose of this mailing list is to serve as a forum for discussion of DORIS data analysis topics (stations, satellites, DORIS instruments, data, analysis, orbits, EOP, products).

The messages are all archived on the mailing list server of CLS at the following address:

<http://listes.cls.fr/www/arc/ids.analysis.forum>

Before the creation of the forum, the Analysis Coordinator had collected 68 messages of conversation between analysts in an archive that can be viewed at http://ids.cls.fr/html/analysis_coord/discussion.html

5.3.4 OTHER MAILING LISTS

ids.central.bureau: list of the Central Bureau

ids.governing.board: list of the Governing Board

ids.cbgb: common list for the Central Bureau and the Governing Board. This list is private.

ids.awg: list of people who attend the AWG, and/or analysis center representatives.

5.4 HELP TO THE USERS

e-mail : IDS.central.bureau@cls.fr

The primary contact for any queries about DORIS and the IDS is the Central Bureau. A list of contact person has been defined for internal use depending on the kind of questions, so as to be able to rapidly respond to any questions that might arise.

In this report period (2006-2008) many exchanges took place with the Analysis Centers and groups which recently started to contribute to IDS combination (University of Newcastle, ESA/ESOC, NASA GSFC, Geoscience Australia).

5.5 FUTURE PLAN

Sections of the IDS Websites are will be updated regularly. The time series page will be revised in the near future, in order to include plots and STCD from each Analysis Centers and from the IDS combination. A station event page will be implemented, in the same way as the system event list. A gallery of pictures from DORIS events and meetings will also be created. The Central Bureau will continue to support any new AC's as they join the service.

6 THE NETWORK

Hervé Fagard (1)

(1) IGN, France

6.1 GENERAL STATUS OF THE NETWORK

The stations that are currently part of the ground segment of the DORIS system can be divided in two groups:

- The “permanent stations”, whose primary purpose is to take part in the orbit determination for the satellites carrying DORIS instruments. Such stations were installed for an *a priori* unlimited period, following an initial CNES and IGN proposal. Nevertheless, some circumstances required that we remove a station and look for another host agency.
- The “IDS stations”, which have been installed following proposals submitted by other organizations with varied scientific motivations, for a limited or undefined period.

Figure 4 shows the evolution of the network between 2006 and 2008.



Figure 4 Network evolution between 2006 and 2008

6.2 RENOVATION PROGRAM OF THE PERMANENT NETWORK

The stations renovation program, initiated in 2000 in order to improve the long-term stability of the antenna support, is now almost complete. A second-generation renovation was carried out at a few sites in order to remove the bent connectors at the base of the antenna. This was done by installing a new support (Fig 2) to raise the antenna base.

In 2006 the following stations were visited by IGN:

- Dionysos (Greece): major renovation
- Djibouti: antenna and support change following corrosion
- Arequipa (Peru): antenna raising
- Hartebeesthoek (South Africa): antenna raising
- Marion Island (South Africa): antenna change following damage

and the following new stations were installed:

- Betio (Kiribati)
- Rikitea (French Polynesia), replacing Rapa

In 2007 the following stations were renovated:

- Crozet (French Antarctic and Austral Territories): antenna raising
- Kerguelen (French Antarctic and Austral Territories): antenna raising
- Amsterdam (French Antarctic and Austral Territories): antenna raising
- Yellowknife (Canada) : antenna raising
- Toulouse (France): major renovation
- Papeete (French Polynesia): antenna change
- Rothera (Antarctica): antenna raising
- Monument Peak (USA): antenna raising

In 2008 the following stations were renovated:

- Terre Adélie (French Antarctic and Austral Territories): antenna raising
- Rio Grande (Argentina): antenna raising

The last Alcatel antenna (Toulouse) was removed in July 2007. Now all DORIS stations in the network are equipped with the Starec model.



6.3 THIRD GENERATION BEACONS DEPLOYMENT STATUS

All beacons in the network are third generation ones, except Socorro (the last 1st generation beacon) and Krasnoyarsk, Fairbanks and Futuna (2nd generation).

6.4 CO-LOCATIONS WITH OTHER IERS TECHNIQUES

The number of co-locations with currently operating stations of the other techniques contributing to IERS is as follows.

- GPS: 38 sites
- SLR: 9 sites
- VLBI: 6 sites

Figure 5 shows the distribution of DORIS co-locations (<10 km) with currently operating GPS (IGS), SLR and VLBI.

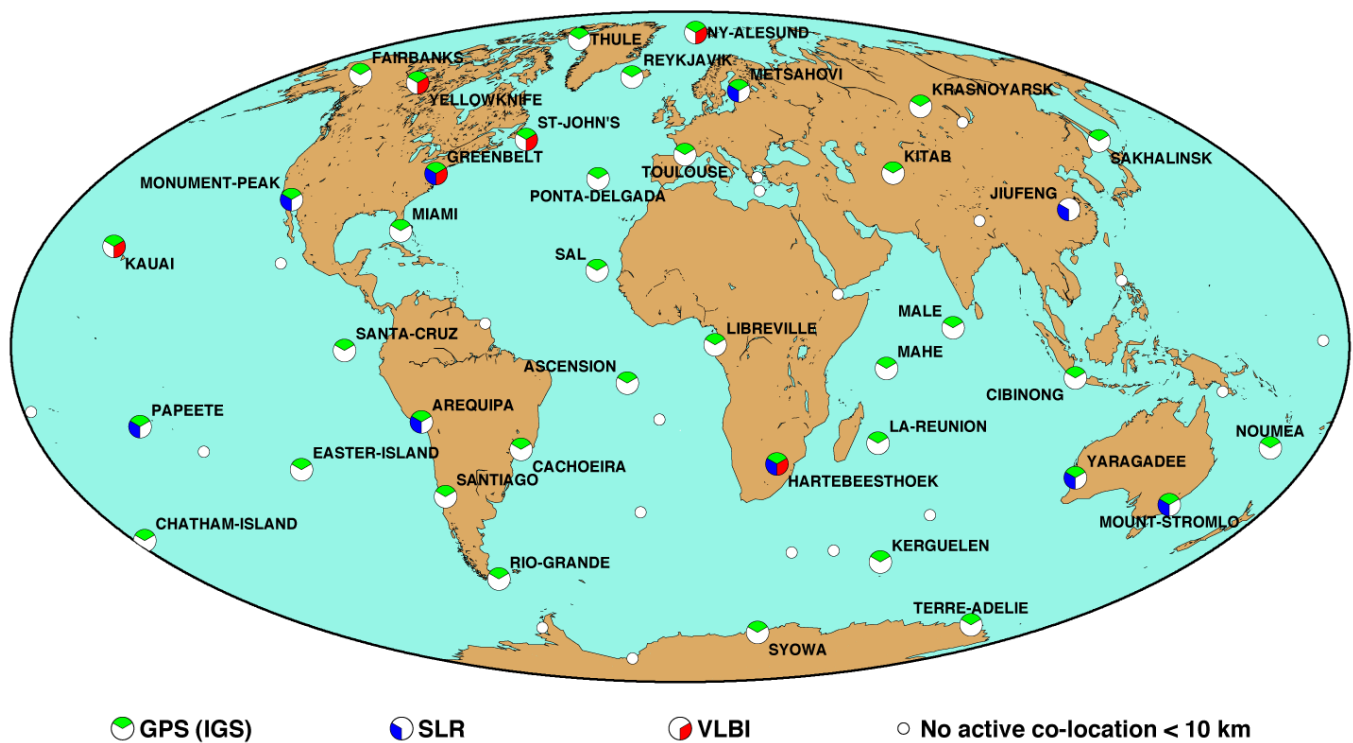

Figure 5 Co-locations with other active IERS techniques

7 THE SATELLITES FITTED OUT WITH DORIS RECEIVERS

Gilles Tavernier (1), Pascale Ferrage (1)

(1) CNES, France

Initially conceived for the TOPEX/Poseidon mission, the first generation receivers were flown on four satellites:

- SPOT-2, a CNES remote sensing satellite which was launched in 1990 with the first DORIS receiver for a 6-month trial experiment. More than 16 years after the launch, this receiver is still fully operational.
- TOPEX/Poseidon, a joint venture between CNES and NASA to map ocean surface topography was launched in 1992. While a 3-year prime mission was planned, with a 5-year store of expendables, TOPEX/Poseidon delivered an astonishing 13+ years of data from orbit: the DORIS mission ended with the second receiver failure in November 2004 whereas the ocean surface topography mapping ended in October 2005,
- SPOT-3 (CNES), which was launched in 1993; the spacecraft was lost in November 1996.
- SPOT-4 (CNES) which was launched in 1998 and featured the first DORIS real time on-board orbit determination (DIODE).

In the mid-nineties, CNES developed a second-generation dual channel DORIS receiver that was subsequently miniaturized:

- Jason-1, the CNES/NASA TOPEX follow-on mission was launched on December 7, 2001 with a miniaturized second generation DORIS receiver. The receiver was switched on December 8. The orbit accuracy of Jason-1 has been demonstrated to be close to one centimeter in the radial component (*Luthcke et al. 2003; Haines et al. 2004*). At the present time, Jason-1 DORIS measurements are not used for geodesy, owing to the South Atlantic Anomaly (SAA) effect on the on-board Ultra Stable Oscillators (USO) (*Willis et al. 2004*), however a correction model has recently been developed (*Lemoine and Capdeville 2006*),
- ENVISAT, the ESA mission to ensure the continuity of the data measurements of the ESA ERS satellites was launched on March 1, 2002 with a second generation DORIS receiver
- SPOT-5 (CNES) was launched on May 4, 2002 with a miniaturized second generation DORIS receiver.

Then, a new generation DORIS receiver was developed starting in 2005. This receiver called DGXX, includes the following main new features:

- (1) The simultaneous tracking capability was increased to seven beacons (from only two in the previous generation of receivers)
 - (2) The new generation USO design provided better frequency stability while crossing SAA, and a better quality of MOE and Jason-2 useful for beacon location determination.
 - (3) New DIODE Navigation software (improved accuracy)
- OSTM/Jason-2 (CNES/NASA/EUMETSAT/NOAA) a TOPEX/Poseidon and Jason-1 follow-on ocean observation mission (same orbit) was launched on June 20 2008. JASON-2 is based on the same PROTEUS platform as Jason-1, but carries the DGXX DORIS.
- Moreover, the satellite STPSAT1 (Plasma Physics and Space Systems Development Divisions, Naval Research Laboratory) with a CITRIS receiver to be used with the DORIS beacon network was launched on March 9, 2007. This experiment is dedicated to global ionospheric measurements; we expect feedback soon.

Figure 6 gives a summary of the satellites providing DORIS data to the IDS data centers, as well as the evolution in time of the number of these satellites. Some of the early SPOT-2 data could not be recovered between 1990 and 1992, due to computer and data format limitations. With the exception of this time period, all DORIS-equipped satellites have provided continuous data to the IDS data centers. Please note the large increase in the number of DORIS satellites around mid-2002.

Note that as Jason-2 was successfully launched in June 2008, the “old” SPOT-2 will be de-orbited in June 2009 (maneuvers will be performed in order to lower the orbit so that the spacecraft will re-enter the Earth’s atmosphere within 25 years).

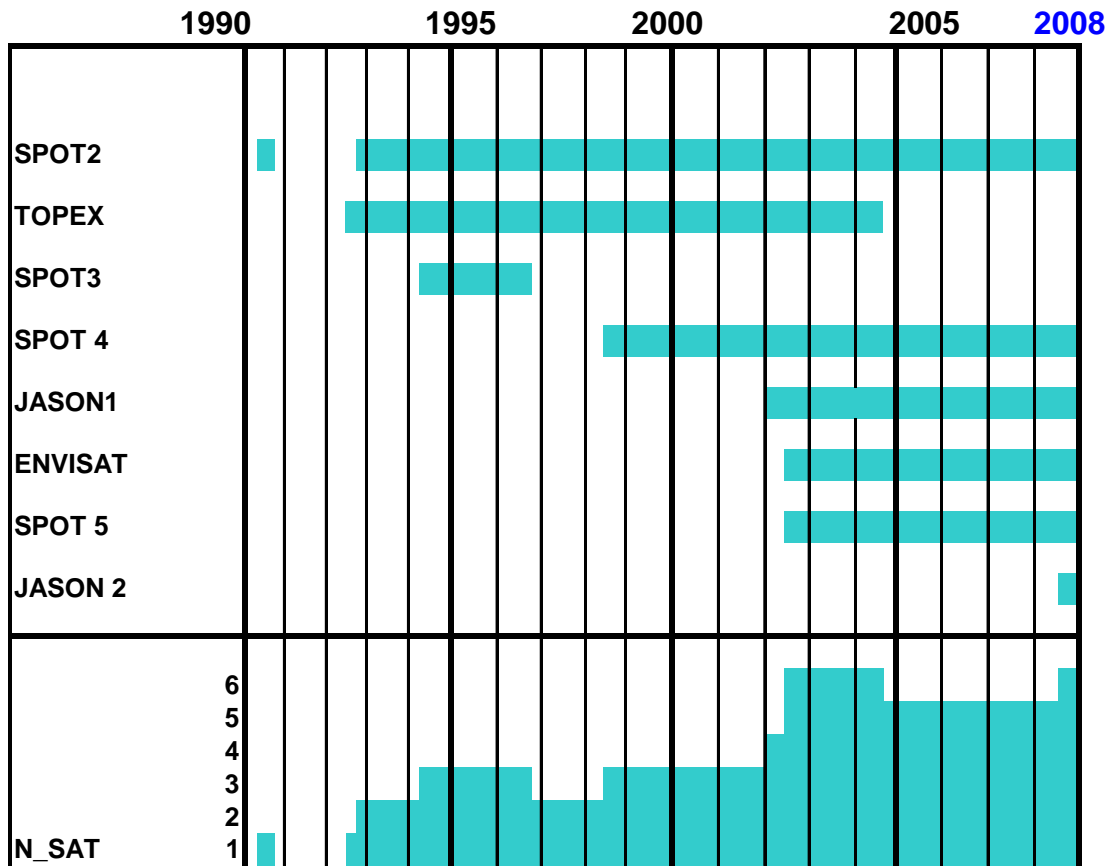
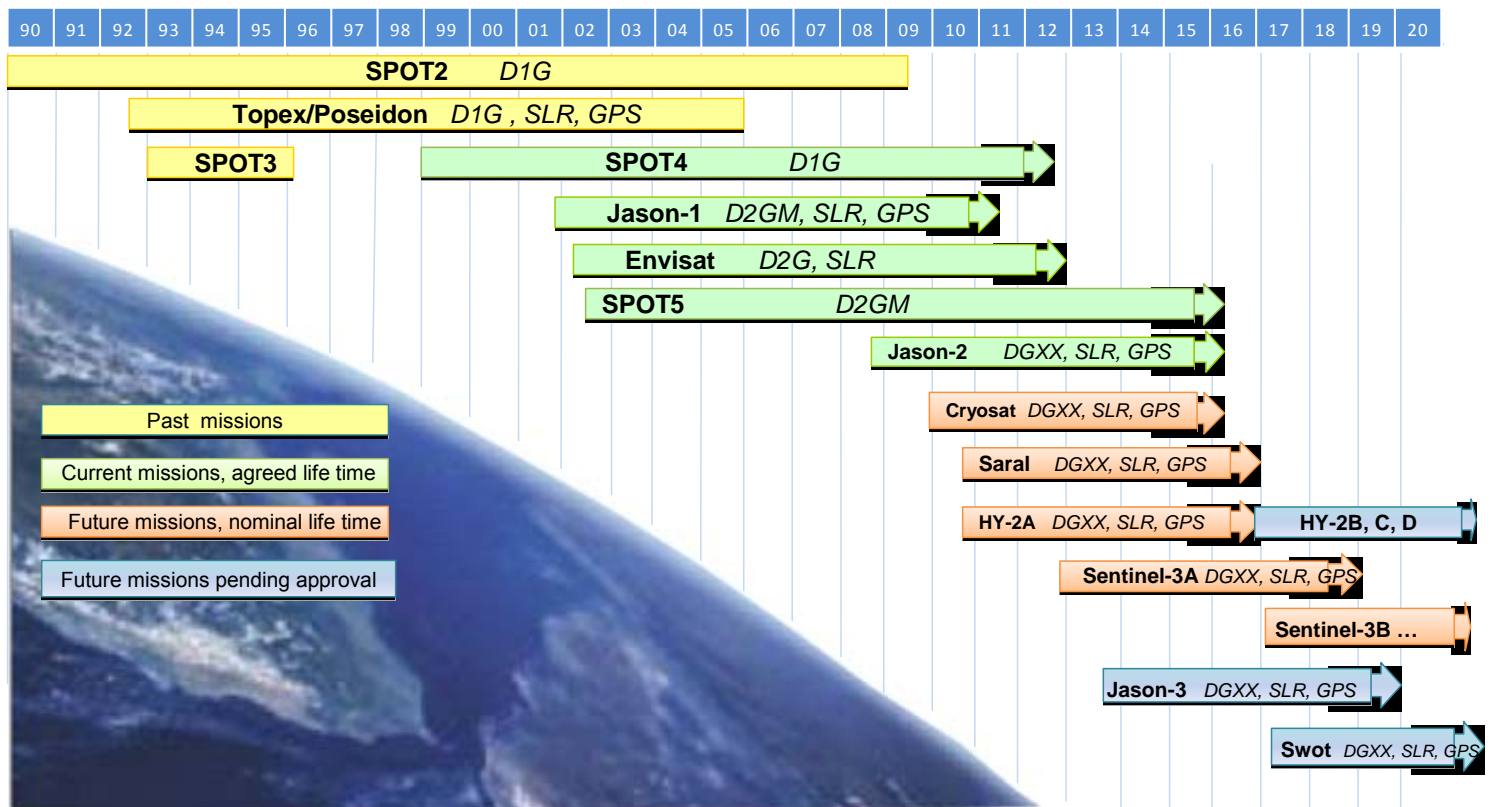

Figure 6 DORIS observations available at the IDS Data Centers (December 2008).

The future DORIS mission are numerous and should guarantee a constellation with at least 4 DORIS contributor satellites over 2020:

- CryoSat-2 (ESA): is to be launched in November 2009
- HY2A (China Academy of Space), is to be launched in June 2010
- SARAL/ALTIKA (ISRO/CNES) is to be launched from mid 2010
- SENTINEL3A (GMES/ESA) is planned for November 2012
- JASON3 (EUMETSAT/NOAA/CNES) is foreseen from mid 2013
- SWOT is foreseen for 2016



On board location system

D1G: DORIS 1G

D2G(M): DORIS 2G (Miniaturized)

DGXX: DORIS 3rd G

GPS: Global Positioning system

SLR : Satellite Laser Ranging

Figure 7 Current and future DORIS constellation (December 2008).

IDS DATA FLOW COORDINATION (2006-2008)

Carey Noll (1)

(1) NASA/GSFC, USA

7.1 INTRODUCTION

Two data centers currently support the archiving and access activities for the IDS:

- Crustal Dynamics Data Information System (CDDIS), NASA GSFC, Greenbelt, MD USA
- Institut Géographique National (IGN), Saint Mandé France

These institutions have archived DORIS data since the launch of TOPEX/Poseidon in 1992.

7.2 FLOW OF IDS DATA AND PRODUCTS

The flow of data, products, and information within the IDS is analogous to what is utilized in the other IAG geometric services (IGS, ILRS, IVS) and is shown in Figure 8. IDS data and products are transmitted from their source to the IDS data centers. DORIS data are downloaded from the satellite at the DORIS control and processing center, SSALTO in Toulouse, France. After validation, SSALTO transmits the data to the IDS data centers. IDS analysis centers, as well as other users, retrieve these data files from the data centers and produce products, which in turn are transmitted to the IDS data centers.

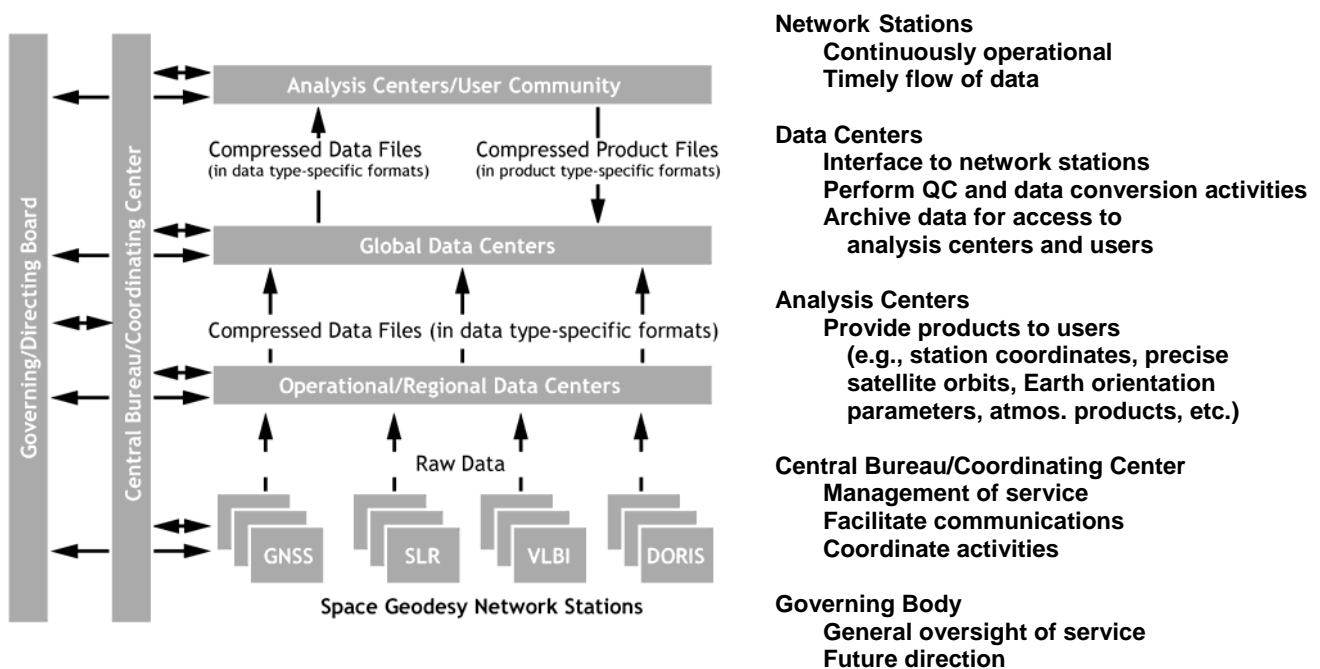

Figure 8 Routine flow of data and information for the IAG Geodetic Services

| Directory | File Name | Description |
|--------------------------------|--------------------------------------|---|
| Data Directories | | |
| /doris/data/sss | sssdataMMM.LLL.Z | DORIS data for satellite <i>sss</i> , cycle number <i>MMM</i> , and version <i>LLL</i> |
| | sss.files | File containing multi-day cycle filenames versus time span for satellite <i>sss</i> |
| /doris/data/sss/sum | sssdataMMM.LLL.sum.Z | Summary of contents of DORIS data file for satellite <i>sss</i> , cycle number <i>MMM</i> , and file version number <i>LLL</i> |
| /doris/data/sss/yyyy | sssrXYYDDD.LLL.Z | DORIS data (RINEX format) for satellite <i>sss</i> , date YYDDD, version number <i>LLL</i> |
| /doris/data/sss/yyyy/sum | sssrXYYDDD.LLL.sum.Z | Summary of contents of DORIS data file for satellite <i>sss</i> , cycle number <i>MMM</i> , and file version number <i>LLL</i> |
| Product Directories | | |
| /doris/orbits/ | ccc/cccsssVV.bXXDDD.eYEEEE.sp1.LLL.Z | Satellite orbits in SP1 format from analysis center <i>ccc</i> , satellite <i>sss</i> , solution version <i>VV</i> , start date year <i>XX</i> and day <i>DDD</i> , end date year <i>YY</i> and day <i>EEE</i> , and file version number <i>LLL</i> |
| /doris/sinex_global/ | cccWWuVV.snX.Z | Global SINEX solutions of station coordinates for analysis center <i>ccc</i> , year <i>WW</i> , content <i>u</i> (d=DORIS, c=multi-technique), and solution version <i>VV</i> |
| /doris/sinex_series/ | ccc/cccYYDDDtUuVV.snX.Z | Time series SINEX solutions for analysis center <i>ccc</i> , starting on year <i>YY</i> and day of year <i>DDD</i> , type <i>t</i> (m=monthly, w=weekly, d=daily) solution, content <i>u</i> (d=DORIS, c=multi-technique), and solution version <i>VV</i> |
| /doris/stcd/ | cccWWtu/cccWWtuVV.stcd.aaaa.Z | Station coordinate time series SINEX solutions for analysis center <i>ccc</i> , for year <i>WW</i> , type <i>t</i> (m=monthly, w=weekly, d=daily), content <i>u</i> (d=DORIS, c=multi-technique), solution version <i>VV</i> , for station <i>aaaa</i> |
| /doris/geoc/ | cccWWtuVV.geoc.Z | TRF origin (geocenter) solutions for analysis center <i>ccc</i> , for year <i>WW</i> , type <i>t</i> (m=monthly, w=weekly, d=daily), content <i>u</i> (d=DORIS, c=multi-technique), and solution version <i>VV</i> |
| /doris/eop/ | cccWWtuVV.eop.Z | Earth orientation parameter solutions for analysis center <i>ccc</i> , for year <i>WW</i> , type <i>t</i> (m=monthly, w=weekly, d=daily), content <i>u</i> (d=DORIS, c=multi-technique), and solution version <i>VV</i> |
| /doris/iono/ | sss/cccsssVV.YYDDD.iono.Z | Ionosphere products for analysis center <i>ccc</i> , satellite <i>sss</i> , solution version <i>VV</i> , and starting on year <i>YY</i> and day of year <i>DDD</i> . |
| Information Directories | | |
| /doris/cb_mirror | | Mirror of IDS central bureau files |

Table 1 Main Directories for IDS Data and Products

The IDS data centers use a common structure for directories and filenames that was implemented in January 2003. This structure is shown in Table 1 and fully described on the IDS Central Bureau website at http://ids.cls.fr/html/analysis_coord/documents/struct_dc.html. The main directories are:

- */pub/doris/data* (for all data) with subdirectories by satellite code
- */pub/doris/products* (for all products) with subdirectories by product type and analysis center
- */pub/doris/cb_mirror* with general information and data and product documentation (maintained by the IDS Central Bureau)

SSALTO and the analysis centers deliver data and products to both IDS data centers (CDDIS and IGN) to ensure redundancy in data delivery in the event one data center is unavailable. The general information available through the IDS Central Bureau ftp site are mirrored by the IDS data centers thus providing users secondary locations for these files as well

7.3 DORIS DATA

SSALTO deposits DORIS data to the CDDIS and IGN servers. Software at the data centers scans these incoming data areas for new files and automatically archives the files to public disk areas using the directory structure and filenames specified by the IDS. The IDS data centers archive DORIS data from six operational satellites (SPOT-2, -4, -5, Jason-1, -2, and ENVISAT); data from future missions (e.g., CryoSat-2, SARAL, etc.) will be archived within the IDS. Historic data from SPOT-3 and TOPEX/Poseidon are also available at the data centers. A summary of DORIS data holdings at the IDS data centers is shown in Table 2. The DORIS data from all satellites are archived in multi-day (satellite dependent) “cycle” files using the DORIS data format 2.1 (since January 15, 2002). The DORIS data files are on average two Mbytes in size (using UNIX compression). SSALTO issues an email notification through DORISReport once data are delivered to the IDS data centers. The number of days per file and average latency of data availability after the last observation day satellite specific are shown in Table 3. The delay in data delivery to the data centers (in days by satellite) is shown in Figure 9.

| Satellite | Time Span |
|------------------|---|
| TOPEX/Poseidon | 25-Sep-1992 through 01-Nov-2004 |
| SPOT-2 | 31-Mar through 04-Jul-1990 04-Nov-1992 through present |
| SPOT-3 | 01-Feb-1994 through 09-Nov-1996 |
| SPOT-4 | 01-May-1998 through present |
| SPOT-5 | 11-Jun-2002 through present |
| Jason-1 | 15-Jan-2002 through present |
| Jason-2 | 12-Jul-2008 through present |
| ENVISAT | 13-Jun-2002 through present |

Table 2 DORIS Data Holdings

| Satellite | Number of Days/ | Average Latency |
|------------------|------------------------|------------------------|
| | Cycle File | (Days) |
| ENVISAT | 6 | 22 |
| Jason-1 | 10 | 18 |
| Jason-2 | 10 | 42* |
| SPOT-2, -4, -5 | 9 | 24 |

*Note: Jason-2 data started mid-2008; latency improved following initial deliveries

Table 3 DORIS Data File Information

DORIS data from Jason-2, launched in June 2008, are also available in RINEX, version 3.0. The Jason-2 satellite houses the newer, next generation DORIS instrumentation capable of generating these data in RINEX format; future satellites will also utilize this type of DORIS receiver. These data are forwarded to the IDS data centers in daily files prior to orbit processing within one day (typically) following the end of the observation day.

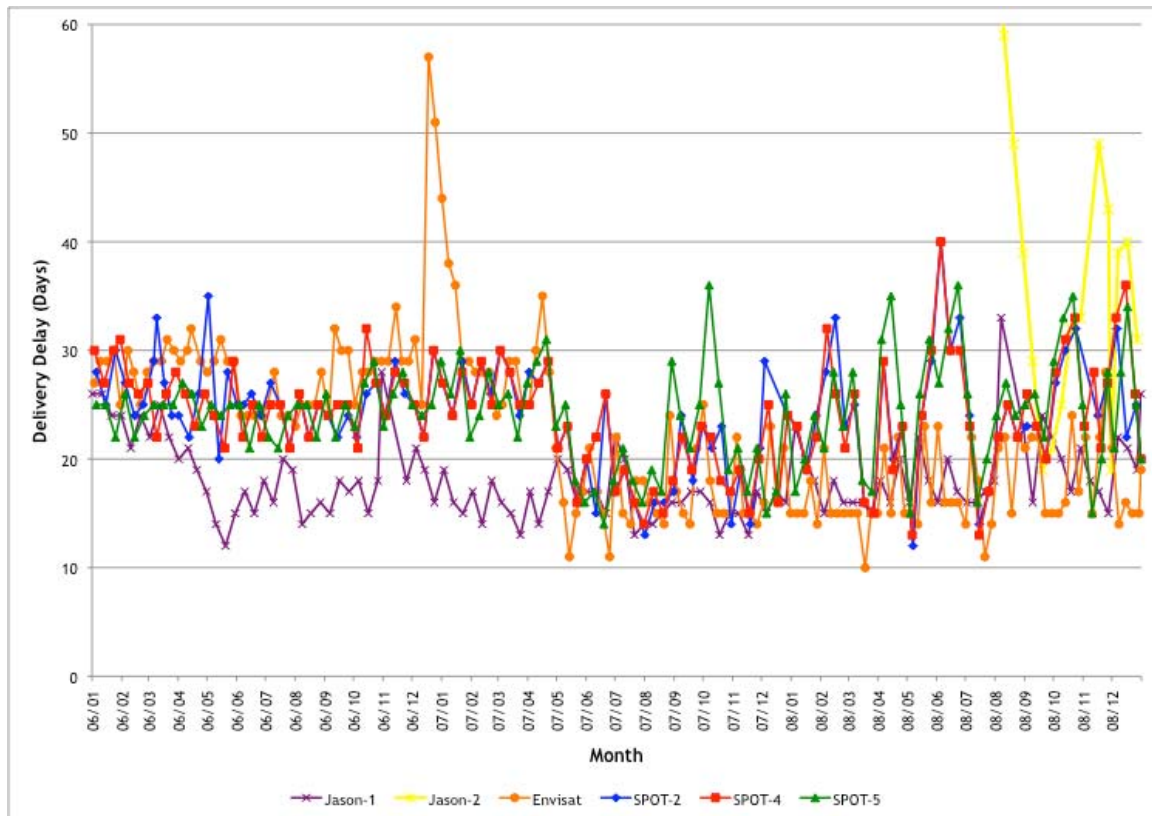

Figure 9 Delay in delivery of DORIS data to the CDDIS (all satellites, 01/2005-12/2008)

7.4 DORIS PRODUCTS

IDS analysis centers utilize similar procedures by putting products to the CDDIS and IGN servers. Automated software detects any incoming product files and archives them to the appropriate product-specific directory. The following analysis centers (AC's) have submitted products on an operational basis to the IDS; their AC code is listed in (>):

- NASA Goddard Space Flight Center (gsc) USA, F. Lemoine
- Institut Géographique National/JPL (ign) France, P. Willis
- CNES/CLS (lca) France, JM. Lemoine, L. Soudarin
- SSALTO (ssa) France, G. Tavernier
- CNES/SOD (sod) France, J.P. Berthias
- INASAN (ina) Russia, S. Kuzin

IDS products are archived by type of solution and analysis center. The types and sources of products available through the IDS data centers in 2005-2008 are shown in Table 4. This table also includes a list of products under evaluation from several proposed DORIS analysis centers.

7.5 FUTURE PLANS

The IDS data centers will investigate procedures to regularly compare holdings of data and products to ensure that the archives are truly identical.

| Type of Product | Operational AC's/Products | | | | | |
|--|---------------------------|---------|---------|---------|---------|-------|
| | GSC | IGN | INA | LCA | SSA | SOD |
| Time series of SINEX solutions | X (W) | X (W,M) | X (W,M) | X (W,M) | X (W,M) | X (W) |
| Global SINEX solutions | | X | | X | | |
| Time series of coordinates of the TRF origin | | X | X | X | | |
| Orbits/satellite | X (5) | | | X (5) | | |
| Ionosphere products/satellite | | | | | X (6) | |
| Time series of EOP | | X | X | | | |
| Time series of station coordinate | | X (W) | X (W) | X (W,M) | X (W) | |
| Type of Product | Proposed AC's/Products | | | | | |
| | GA | GOP | GRG | IGN | INA | |
| Time series of SINEX solutions | X (W) | X (W) | | | | |
| Orbits/satellite | | | X | X (7) | X (7) | |

Notes: W=weekly solution

M=monthly solution

Table 4 IDS Product Types and Contributing Analysis Centers

8 IDS DATA CENTERS

Carey Noll (1), B. Garayt (2)

(1) NASA/GSFC, USA

(2) IGN, France

8.1 CRUSTAL DYNAMICS DATA INFORMATION SYSTEM (CDDIS)

8.1.1 PRESENTATION

The CDDIS is a dedicated data center supporting the international space geodesy community since 1982. The CDDIS serves as one of the primary data centers for the following IAG services:

- International GNSS Service (IGS)
- International Laser Ranging Service (ILRS)
- International VLBI Service for Geodesy and Astrometry (IVS)
- International DORIS Service (IDS)
- International Earth Rotation Service (IERS)

The CDDIS automated software archives data submitted by SSALTO and performs minimal quality-checks (e.g., file readability, format compliance) resulting in a summary file for each data file. Software extracts metadata from all incoming DORIS data. These metadata include satellite, time span, station, and number of observations per pass. The metadata are loaded into a database and utilized to generate data holding reports on a daily basis. Approximately 20Gbytes of CDDIS disk space is devoted to the archive of DORIS data, products, and information.

During 2008, over 350 international groups downloaded over 100 Gbytes of DORIS data and information from the CDDIS.

8.1.2 CDDIS FUTURE PLANS

The CDDIS plans to be operational in a new distributed server environment by spring 2009. The structure of the DORIS data and product archive will remain unchanged in this new system configuration.

8.1.3 CDDIS CONTACT

| | |
|---------------------------|--|
| Carey Noll, CDDIS Manager | Email: Carey.Noll@nasa.gov |
| NASA GSFC | Voice: 301-614-6542 |
| Code 690 | Fax: 301-614-6015 |
| Greenbelt, MD 20771 | ftp: ftp://cddis.gsfc.nasa.gov/pub/doris |
| USA | WWW: http://cddis.gsfc.nasa.gov |

8.2 IGN DORIS DATA CENTER

The IDS Data Center at IGN has been renewed in early 2007 and is now operated in support of the IDS activities. It is an independent data center from the CDDIS archive one even if some mirrorings are made with it to complete the information.

This activity is handled by the geodetic and levelling department (SGN) which is the operational geodesy service of the French national mapping agency (IGN). Development and maintenance of the DORIS Data Center at IGN is a collaborative effort of the following persons :

- Eric FOURESTIER (eric.fourestier@ign.fr) : computer system administrator
- Bruno GARAYT (bruno.garayt@ign.fr) : person in charge of the IGS and IDS data centers related activities

The IDS Data Centers at IGN provides ftp access to:

- * DORIS metadata at <ftp://doris.ensg.ign.fr/pub/doris/general>

<<ftp://cddis.gsfc.nasa.gov/doris/products>>

- * DORIS data for all IDS satellites or for some specific campaign at

<ftp://doris.ensg.ign.fr/pub/doris/data>

<<ftp://cddis.gsfc.nasa.gov/doris/products>>

- * DORIS products at <ftp://doris.ensg.ign.fr/pub/doris/products>

<<ftp://cddis.gsfc.nasa.gov/doris/products>>

To have a more reliable data flow and a better availability of the service, two identical configurations have been setup in two different locations in IGN: Marne-la-Vallée and Saint-Mandé.

Only the accesses are different. The users just need to change `doris.ensg.ign.fr` with `doris.ign.fr` in the links above.

The ftp archive of DORIS data, products, and general information follows the file naming conventions established and maintained by the Analysis coordination (IDS data structure and formats <http://ids.cls.fr/html/analysis_coord/documents/struct_dc.html>). Many DORIS data and product files archived at the IGN are stored in UNIX compress format and end in a .Z.

9 IDS ANALYSIS COORDINATION

Frank Lemoine (1)

(1) NASA/GSFC, USA

9.1 ANALYSIS COORDINATION

The coordination of IDS Analysis activities in these three years including the testing of ITRF2005, the validation of new Analysis Centers to the IDS and the validation of their orbit and SINEX products, and extensive testing and model preparations in view of the development of the IDS submission for ITRF2008. Between 2006 and 2008, the IDS Analysts met four times: once in a workshop to discuss ITRF2005 preliminary solution validation (June 2006, Toulouse, France), and twice as in Analysis Working Group Meetings and once in a workshop following the Jason-1/2 Ocean Surface Topography Meeting.

2008 Analysis Working Group Meetings (Paris, France)

-March 13-14, 2008; URL: <http://ids.cls.fr/html/report/meetings/AWG200803.html>

-June 5-6, 2008; URL: <http://ids.cls.fr/html/report/meetings/AWG200806.html>

2008 IDS Workshop (Nice, France)

-Nov. 12-14, 2008; URL: http://ids.cls.fr/html/report/ids_workshop_2008/welcome.html

Extensive orbit determination results pertaining to TOPEX/Poseidon and Jason-1 were reported also at the Ocean Surface Topography Science Team (OSTST) meeting in Hobart, Tasmania (March 2007) by the CNES, the GRGS, NASA GSFC, and the University of Texas/Center for Space Research.

(URL: <http://www.aviso.oceanobs.com/en/courses/ostst/ostst-2007/index.html>)

For the first time, the IDS has prepared a combination for ITRF2008, testing the procedures for assimilation of the individual solutions, and producing the IDS Combination with the CATREF software (*Altamimi et al., 2002*). At the start of the report period, only three IDS analysis centers had previously submitted SINEX solutions as contributors to the ITRF2005 solution. These included IGN, LCA and INA. At the end of the report period, eight analysis centers had submitted SINEX files, in view of the ITRF2008, including: IGN, LCA, Geodetic Observatory Pecny (GOP), the European Space Operations Center (ESA), Geoscience Australia (GAU), the NASA Goddard Space Flight Center (GSC), and the Newcastle University (NCL). In addition, to

these analysis centers, the precise orbit determination group of the CNES (SOD) actively participated in the analysis activities, especially in the ITRF2005 evaluation, and in the model tests in view of the development of the GDR-C standards for Jason-1, and in the report on the preliminary orbit determination results for the Jason-2 spacecraft.

The analysis centers that have actively participated in AWG meetings and the IDS Workshop are listed in Table 5. We note that the analysis center contributions include six distinct sets of orbit determination software. NAPEOS is used by ESOC for its operational orbit determination for ENVISAT and for use in processing GPS data; Bernese was modified to process DORIS data, even though it has been used previously principally to process GPS data. Gipsy has been used by the IGN and INA to process DORIS data and enjoys a large GPS user base. GINS (Géodésie par Intégration Numériques Simultanées) has been used by the GRGS to process SLR, DORIS, GPS, and GRACE satellite-satellite K Band Range-Rate (KBRR) data. The NASA GEODYN software has been used to process DORIS data since prior to the launch of the TOPEX/Poseidon mission in 1992 and is the central orbit determination software for this POD group. GEODYN is also used by Geoscience Australia (GAU).

During the AWG meetings in 2008, each analysis center reviewed the capabilities of their orbit determination software, and made the necessary modifications to be compliant with the latest IERS2003 standards, to the extent this was possible given their available manpower and computational resources. Orbit tests (whose results will be briefly reviewed) demonstrated that the analysis centers all produced orbits of comparable quality, demonstrating that they all are operating at a similar level of performance. The challenges then for a successful analysis center submission to ITRF2008 then concern the proper application of *a priori* constraints in the arc parameter reduction and the SINEX solution development, and the application of up-to-date troposphere models and mapping functions.

Significant updates in processing standards for DORIS data in this analysis period included the application of new GRACE-derived gravity models (cf. EIGEN-GL04S, GGM03S, EGM20008), the application of new ocean tide models (FES2004 and GOT4.7), the application of atmospheric gravity (from ECMWF or NCEP in the form of six-hour sets of ΔC_{lm} & ΔS_{lm} coefficients), the application of the GPT model (*Boehm et al., 2007*) for *a priori* meteorological

data, the use of the GMF (*Boehm et al., 2006*) mapping function for troposphere modelling. Although some analysis centers adopted the periodic variations in the geopotential (e.g. GSFC, LCA, ESA) derived from GRACE for the annual and possibly the semiannual terms, it was recommended that the AC's not adopt the linear rate terms for the non-zonal terms (e.g. C_{31} , C_{41} , S_{31} , S_{41} and higher), since the GRACE solutions available estimated these rates over too short a time period. It was recommended that the analysis centers follow the IERS recommendations, and model C_{21} and S_{21} and their linear rates for each gravity model according to the IERS standards (*McCarthy and Petit, 2004*).

The University College London (UCL) developed improved models for modelling of radiation pressure on the Jason-1 and ENVISAT satellites centers (*Ziebart, 2004; Ziebart et al., 2005; Sibthorpe, 2006*), and these were extensively tested by the GSFC and CNES analysis centers. The IGN analysis center tested and reported a new strategy to tune the solar radiation pressure coefficients of individual satellite macromodels to reduce radiation pressure mismodelling. They report (*Gobinddass et al., 2009, submitted*) that the geocenter derived from DORIS is significantly improved, since the once-per-rev revolution parameters that soak up the mismodelling alias directly with the Z coordinate of geocenter at the draconic period (~120 days for TOPEX/Poseidon and Jason-1, and ~365 days for the sun-synchronous SPOT and ENVISAT satellites).

An update to the ITRF2005 coordinate set was developed by Pascal Willis (IGN) and colleagues, designated DPOD2005 (*Willis et al., 2009*). The DPOD2005 (hosted at the URL <http://www.ipgp.jussieu.fr/~willis/DPOD2005.htm>) represents a significant update to ITRF2005 and was recommended as the *a priori* for the ITRF2008 analysis. The model corrected certain deficiencies of the ITRF2005 network solution with respect to certain stations (e.g. Arequipa after the June 2001 earthquake) and provided coordinates for new DORIS stations not in ITRF2005.

A major problem with the DORIS oscillator on the Jason-1 spacecraft seriously complicated the orbit determination for that spacecraft. Since the Ultra Stable Oscillator (USO) was not properly annealed prior to launch, the DORIS USO is subject to disturbances every time the spacecraft transits the South Atlantic Anomaly (SAA) (*Willis et al. 2004*). *Lemoine and Capdeville (2006)*

developed an SAA correction model for the Jason-1 DORIS data, which improves the orbit determination for this satellite. The CNES and the NASA GSFC report improvements to Jason-1 POD using this model. For example, *Beckley et al. (2007)* report that the SAA correction applied over 177 test cycles, improves the RMS of fit from 0.4078 mm/s to 0.3740 mm/s, the SLR fit from 1.482 cm to 1.440 cm, and the independent altimeter crossover fit from 5.585 cm to 5.578 cm. Nonetheless, the application of the SAA model does not necessarily improve the quality of the data sufficiently to allow Jason-1 to be used in ITRF solution development. Therefore, for ITRF2008, it was recommended that the AC's only include Jason-1 for 2002, prior to the launch of the SPOT-5 and ENVISAT satellites. In this way, the additional geometry provided by Jason-1 might benefit the solution and the effect of the degradation in the USO that compromised the Jason-1 data most severely in the later Jason cycles would be avoided.

| AC | Affiliation | Software | Contact |
|--|---|----------|--|
| ESA¶ | ESOC (Darmstadt, Germany) | NAPEOS | Michiel.Otten@esa.int |
| GOP¶ | Geodesy Observatory Pecny, (Ondrejov, Czech Republic) | Bernese | (Petr Stepanek) pste@centrum.cz |
| GAU¶ | Geoscience Australia (Canberra, Australia) | GEODYN | Ramesh.Govind@ga.gov.au |
| GSC¶ | NASA Goddard Space Flight Center (Greenbelt, USA) | GEODYN | Frank.G.Lemoine@nasa.gov nzelensky@sgt-inc.com Karine.Lebail@nasa.gov Douglas.S.Chinn@nasa.gov |
| IGN¶ | IGN/IPGP (Paris, France) | Gipsy | (Pascal Willis, Marie-Line Gobinddass) willis@ipgp.jussieu.fr gobinddass@ipgp.jussieu.fr |
| INA¶ | Institute of Astronomy Russian Academy of Sciences (Moscow, Russia) | Gipsy | (Sergey Kuzin) skuzin@inasan.rssi.ru |
| LCA¶ | LEGOS/CLS, then CNES/CLS (Toulouse, France) | GINs | Laurent.Soudarin@cls.fr Jean-Michel.Lemoine@cnes.fr Jean-Francois.Cretaux@cnes.fr |
| NCL¶ | Newcastle University (Newcastle, UK) | FAUST | (Philip Moore) philip.moore@ncl.ac.uk |
| SOD | Centre National d'Etudes Spaciales, Toulouse, France | ZOOM | Luca.Cerri@cnes.fr Flavien.Mercier@cnes.fr |
| CSR | University of Texas, Center for Space Research | UTOPIA | (John Ries) ries@csr.utexas.edu |
| As of December 2008, submitted SINEX solutions for validation in view of the computations for the preparation of the ITRF2008 IDS combination. | | | |

Table 5 Summary of IDS Analysis Centers (AC's)

9.2 ORBIT TESTS: RESULTS OF PRELIMINARY ORBIT COMPARISONS

As part of the process of validating new analysis center contributions, beginning with the first AWG meeting in March 2008 orbit comparisons were carried out on DORIS-only orbits between the different analysis centers. This made it possible to quantify the level of modelling agreement (or disagreement) between the centers, and ascertain if certain analysis centers had anomalies that might compromise their AC SINEX submissions. It also allowed the new analysis centers to validate their processing with respect to the other analysis centers. Initially the comparisons focused on 2005.

Examples of the orbit differences for 2005 are shown in Table 6 for SPOT-2, and in Table 7 for SPOT-4. Illustrations of typical sets of orbit differences are shown for SPOT-2, SPOT-4, SPOT-5 and ENVISAT in Figures 10-13. The overall agreements are 1-2 cm RMS in the radial component, and no more than 6-10 cm RMS in the cross-track and along-track directions. GOP, IGN, and INA supplied weekly orbits; LCA supplied 3.5-day arcs; GAU and GSC supplied 7-day arcs (all except for breaks due to maneuvers).

| Series Compared | Radial | Cross-tr. | Along-tr. | Narc |
|--------------------|--------|-----------|-----------|------|
| AUS5 vs GSFC-base. | 0.57 | 2.52 | 3.83 | 43 |
| AUS5 vs IGN2 | 1.35 | 5.55 | 4.38 | 311 |
| GOP vs GSFC-10dg | 1.92 | 5.13 | 8.22 | 20 |
| GOP vs IGN2 | 2.13 | 4.99 | 7.32 | 19 |
| IGN2 vs GSFC-base | 1.34 | 3.93 | 5.52 | 347 |
| IGN2 vs INA2 | 0.91 | 2.10 | 2.23 | 344 |
| INA2 vs GSFC-10dg | 1.55 | 4.47 | 5.76 | 333 |
| LCA vs GSFC-base. | 1.02 | 3.16 | 4.64 | 95 |

Table 6 Summary of Orbit Comparisons for SPOT-2 orbits in 2005 (Units are cm).

| Series Compared | Radial | Cross-tr. | Along-tr. | N |
|--------------------|--------|-----------|-----------|-----|
| AUS5 vs GSFC-base. | 0.45 | 2.31 | 1.41 | 49 |
| AUS5 vs GOP | 1.79 | 4.92 | 6.66 | 32 |
| AUS5 vs IGN3 | 1.28 | 4.32 | 3.92 | 339 |
| GOP vs GSFC-10dg | 1.77 | 5.10 | 6.79 | 31 |
| IGN3 vs GSFC-base. | 1.29 | 4.33 | 4.38 | 356 |
| GOP vs IGN3 | 1.97 | 4.82 | 6.67 | 30 |
| IGN3 vs LCA | 1.32 | 3.92 | 3.70 | 322 |
| INA2 vs GSFC-10dg | 1.44 | 4.14 | 4.85 | 287 |

Table 7 Summary of Orbit Comparisons for SPOT-4 orbits in 2005 (Units are cm)

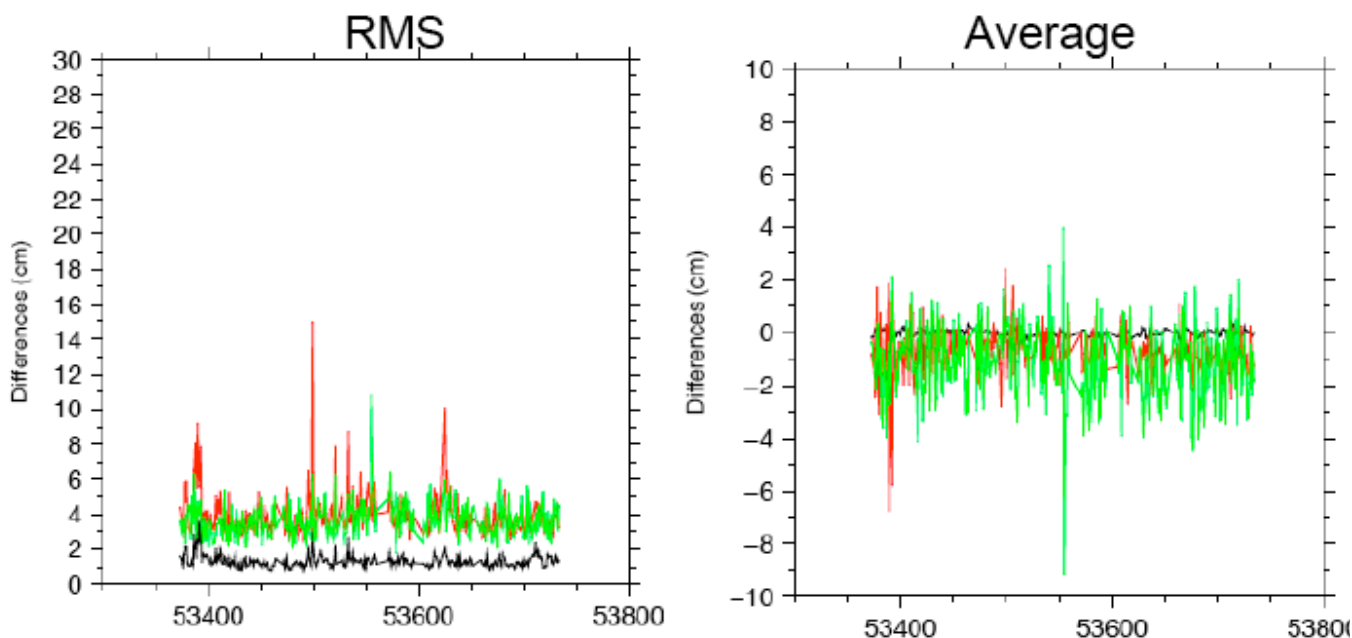

Figure 10 Radial (black), Along-track (green) and Cross-track (red) RMS and average differences for SPOT-4 orbits in 2005 between IGN and LCA.

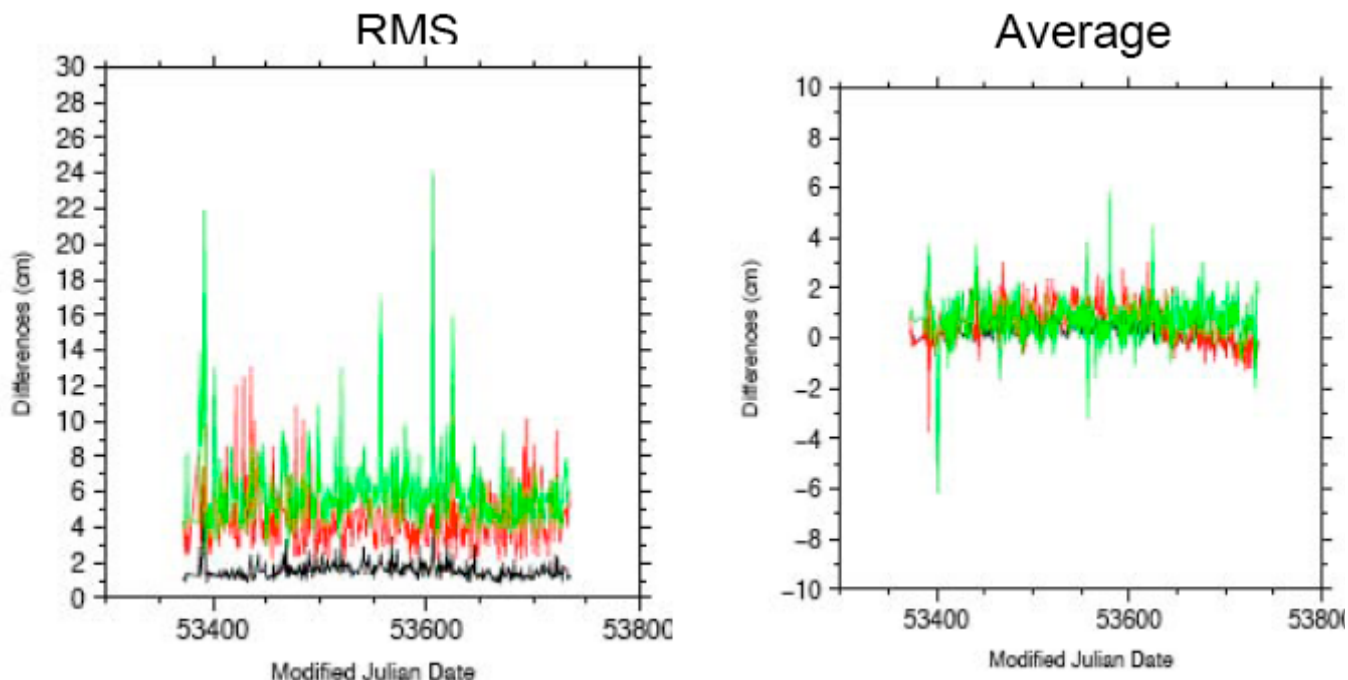

Figure 11 Radial (black), Along-track (green) and Cross-track (red) RMS and average differences for SPOT-2 orbits in 2005 between GSFC (10-deg elevation cutoff) and INA).

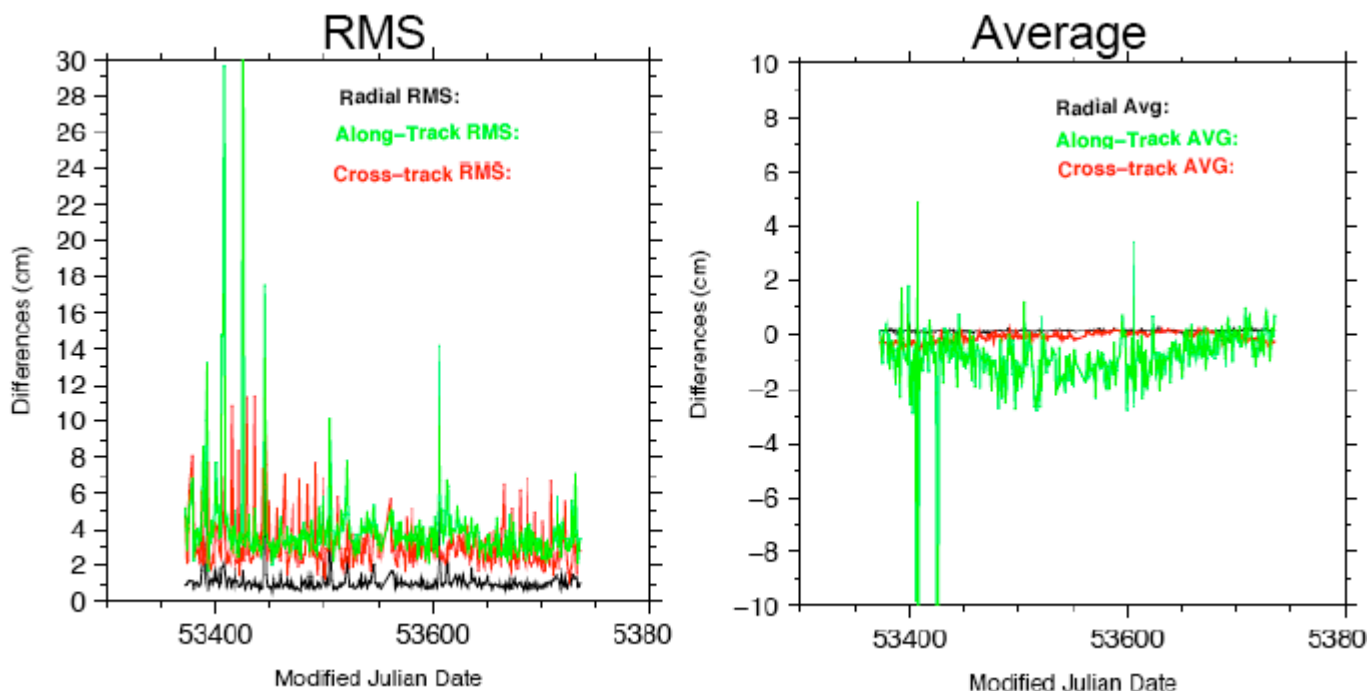

Figure 12 Radial (black), Along-track (green) and Cross-track (red) RMS and average differences for ENVISAT orbits in 2005 between ESA and GAU (Geoscience Australia).

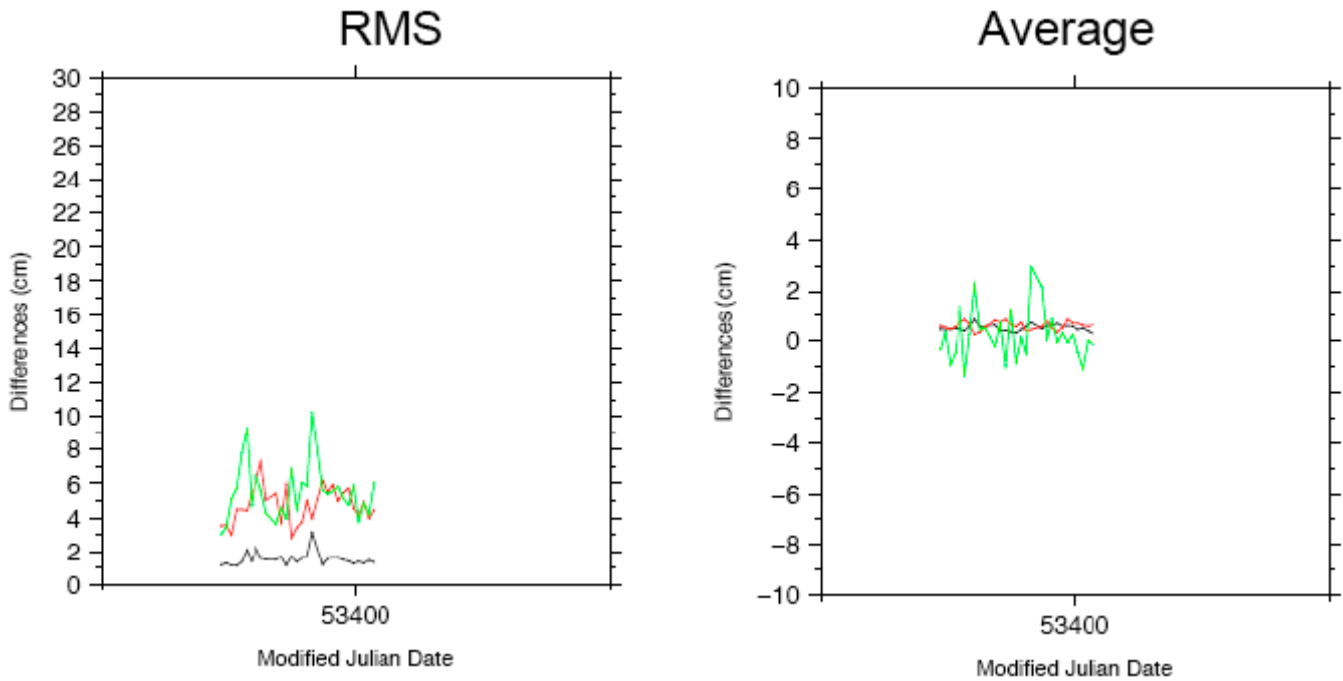

Figure 13 Radial (black), Along-track (green) and Cross-track (red) RMS and average differences for SPOT-5 orbits in 2005 between GSFC (10-deg elevation cutoff) and GOP.

The orbit submissions by GSC and GAU represented their preliminary submissions in view of ITRF2005. Some offsets on the order of 1 cm appear in the mean differences between some of the analysis centers, and there is on occasion an annual signature in these mean differences. The orbit tests were useful because they identified an offset modelling anomaly in the early versions of the LCA ENVISAT orbits and possible setup errors in the first sets of GAU orbits that were later corrected. Although the orbit agreement is quite good, orbit agreement is a necessary, but not a sufficient, condition for production of a satisfactory SINEX solution for inclusion in ITRF2008.

9.3 SINEX FILE VALIDATION

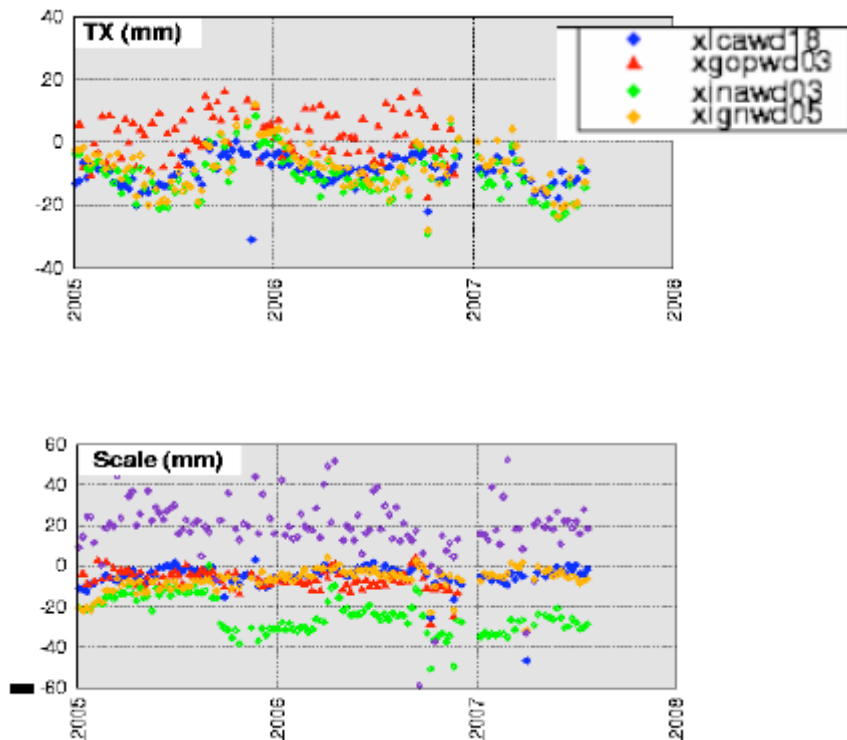

Figure 14 Geocenter (TX) and scale toward ITRF2005 for test SINEX series submitted by LCA, GOP, INA, IGN, and GAU (June 2008).

In addition to testing the processing and orbit modelling, it is necessary to test the SINEX solutions submitted by the analysis centers to be sure they did not present any anomalies and that they could produce a solution that was fully compatible with the IDS combination and ITRF2005. In Figure 14 is shown the geocenter and scale of individual analysis center submissions from LCA, GOP, INA, and IGN and GAU. In all cases these pertained to the preliminary or test submissions for ITRF2005. The tests showed that with respect to the X geocenter parameter, the LCA, GOP, INA and IGN solutions were sensible and fully compatible with ITRF2005, producing a reasonable annual signal. In contrast, the break in the scale for the INA series occurred after September 2005, when a software change caused more data to be available at low elevations (below 10 degrees). Since INA had not edited data for low elevation, this altered the scale of the solution. Prior to its final ITRF submission, INA reprocessed the data after 2005.75 to apply an elevation cutoff constraint. The scale offset in the GAU/GSC solution was more puzzling, but was eventually traced to (1) use of the DORIS meteorological data rather than external model (GPT) as recommended in the processing standards; (2) The use of an older mapping function (Hopfield) in the troposphere estimation. For GAU and GSC, the application of the Neill mapping function (*Neill et al., 1996*) eventually removed the bias in scale

(the GMF mapping function was not yet available in GEODYN). This was a good example of a modelling issue that did not necessarily affect the orbit determination and affected the orbits only slightly, but deleteriously affected the scale and quality of the analysis center station solutions.

Figure 15 summarizes the analysis center submission status as of November 2008 and illustrates the WRMS in mm of the ITRF2005 weekly combinations. It is notable that we see a WRMS of 10-18 mm after 2005 (when SPOT-5 and ENVISAT started to be included in the weekly solutions).

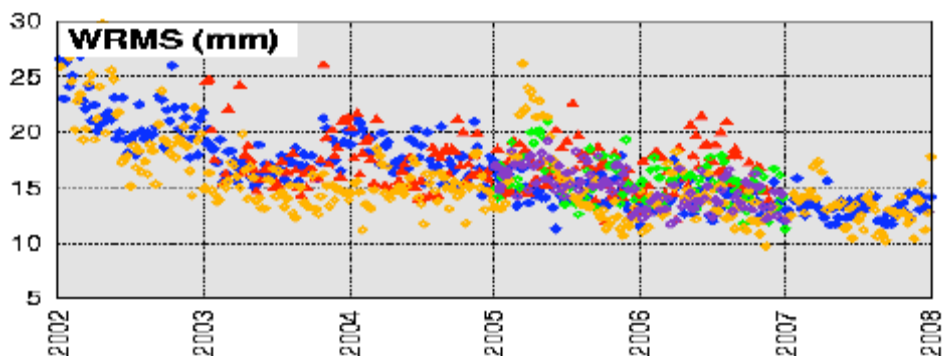

Figure 15 WRMS of the ITRF2005 weekly combinations for the analysis center submissions as of November 2008. The WRMS attains 10-18 mm after 2005 when SPOT-5 and ENVISAT started to be part of the weekly solutions.

9.4 ANALYSIS CENTERS STATUS AS OF DECEMBER 2008

As of December 2008, the following analysis centers promised to complete SINEX submissions that included all data from 1993 to 2008: IGN, LCA, GOP, INA, ESA. Both GAU and GSC intended to submit solutions at least from 2003 to 2008, and longer if schedule permitted, and the scale issue in the SINEX files was resolved. IGN planned to submit a new SINEX series using an updated version of the Gipsy software, the GGM03S gravity model, and the improvements to the radiation pressure modelling that they had discussed in the IDS AWG meetings and IDS workshops. LCA modified its series to replace its ENVISAT normal equations, correcting a problem in the offset modelling for the satellite (while the other analysis centers use the DORIS-data supplied offset, LCA computes and applies its own center of mass and antenna offset corrections to the DORIS data with GINS). ESA submitted an updated series (esawd03) that corrected the smooth scale evident in the esawd01 solution, removed SPOT-4 in 1998 to avoid contamination of the data, added 1997, and implemented other SINEX generation fixes.

Thus, as of December 2008, we anticipated that at least five analysis centers with four distinct software packages would submit SINEX solutions from 1993 to 2008. Orbit tests were completed with NCL and GSFC orbits, and the agreements were comparable to those shown in Tables 6 and 7.

Another aspect of the coordination of analyses is to assure that the analysis centers that use the same software, differentiate themselves with respect to their analysis strategy. This is an important consideration, since in the combination we do not want to receive two identical (or nearly-identical) solutions that would effectively double weight the contribution (and processing peculiarities) of that software. In Table 8 and Table 9, we list the major differences in processing strategy for the IGN and INA analysis centers (using Gipsy) and GSC and GAU analysis centers using GEODYN.

| Standard | IGN (ignwd08) | INA (inawd03) |
|-------------------------------|--|---|
| Software | GIPSY/OASIS 5.0 | GIPSY/OASIS 4.03 |
| Gravity Model | GGM03S (120x120) | GGM01C (120x120) |
| C_{21} / S_{21} | GGM03S | GGM01C |
| Gravity Field rates | GGM03S | GGM01C |
| Atmospheric Gravity | Not Applied | Not Applied |
| Ocean tides | FES2004 | CSR3 |
| Ocean loading | FES2004 | FES2002 |
| Atmospheric Density | DTM94 | DTM94 |
| Drag Parameterization | Cd/hr (ENV, SPOT's) Cd/day (TOPEX) | Cd/6 hrs |
| Macromodel | CNES | CNES |
| Tuned SRP Cr | Fixed (tuned) as per submitted article. | No |
| Troposphere Mapping Func. | GMF | Lanyi |
| Elevation Cutoff | 10° | 0° before 2005.75; 15° 2005.75 and later. |
| Elevation Downweighting Func. | Yes. | No. |
| A priori Met Data | A priori formula for Pressure $1.013 * 2.27 * \exp(-.000116 * \text{height})$ | Same |

Table 8 ITRF2008 modelling standards for the Gipsy Analysis Centers

| Standard | GSC (gscwd10) | GAU (gauwd08) |
|---|--|--|
| Software | GEODYN 0812 | GEODYN 0712 to 2009.0 |
| Gravity Model | EIGEN GL04S1 (120x120) | GGM02C (120x120) |
| C_{21} / S_{21} | IERS Standards | GGM02C |
| Gravity Field Rates | IERS ($C_{21} S_{21}$) EIGEN-GL04S (C_{20}, C_{30}, C_{40}) | GGM02C |
| Time-variable gravity Annual 20x20 from GRACE | From four-year average of monthly GRACE- derived GSFC spherical harmonic solutions. | From two-year average of monthly GRACE-derived GSFC spherical harmonic solutions <i>(Luthcke et al., 2006)</i> |
| Atmospheric Gravity | ECMWF-6hr (50x50) | NCEP-6hr (50x50) |
| Ocean tides | GOT4.7p | GOT4.7p |
| Ocean loading | GOT4.7p | GOT4.7p |
| Atmospheric Density | MSIS86 | MSIS86 |
| Drag Parameterization | Cd/2-hr (ENV, SPOT's); Cd/1-hr 2001-2002 Cd/8hr (TOPEX) | Cd/6-hr SP2, SP4, ENV; SP5; |
| Macromodel | CNES: SP4, SP5 GSFC: TOPEX, SP2, SP3 UCL: ENVISAT | CNES: ENV SP2, SP4, SP5 |
| Tuned SRP Cr or Macromodel | Yes for SP2, SP3, SP4, SP5. Cr's fixed. | Cr's or macromodel not tuned. Cr's adjust with light constraint (0.01), except for ENV. |
| Troposphere Mapping Func. | Niell | Niell |
| Elevation Cutoff | 10° | 12° |
| Elevation Downwting | No | No. |
| A priori Met Data | GPT | GPT |
| Include Jason-1 in 2002 | No | Yes, only first half of 2002. |

Table 9 ITRF2008 modelling standards for the GEODYN Analysis Centers

10 IDS COMBINATION

Jean Jacques Valette (1)

(1) CLS, France

10.1 ACTIVITY SUMMARY

2006-2008 was a very productive period for IDS and particularly for the IDS combination. In 2006, IGN/IPGP and CNES/CLS were the most mature AC, the first being the only one to provide operational weekly solutions. However, three AC's preferably with three different softwares were considered as the minimum to start a reliable combination work. During 2007, more recent AC's such as Pecny Observatory or Geosciences Australia concentrated their efforts to improve their models and to align the SINEX performance to the other AC's. At the same time, specific procedures were defined and implemented in order to validate the series and finally generate a first weekly combined solutions series for the period of 2005 to 2006 (poster presented at AGU07). 2008 is probably the key year for the IDS in the sense that a dramatic march occurred stimulated by a strong priority given by the Central Bureau and the analysis coordinator to the contribution to the ITRF2008 realization. Three AWG meetings were organized since March 2008 until April 2009. The definition of standards and very active interaction lead to the IDS-1 combined series. It is based on 7 AC's SINEX and its quality is very satisfactory. Newcastle University, the most recent group to process DORIS data, is very near to joining the IDS after just a few months of SINEX submissions. As result of all these factors, considerable progress has been made .

10.2 IDS VALIDATION OF SINEX

To validate the AC SINEX a procedure was defined in 2007. It is applied as soon as an analyst provides a new series. For the preparation of ITRF2008, the IDS Central Bureau policy was clearly to provide a response to a new solution delivery as quickly as possible especially for testing new model or standard before a complete reprocessing. The preprocessing of the SINEX solutions is realized per AC series and includes the following steps :

- verification of DORIS station identification (dome #, mnemonic)
- rejection of stations over the whole time period (never used),
- rejection of stations over specific periods (partially used),
- verification of solution number and discontinuities (breaks - to be consolidated before weekly combination by analysis of all AC stations times series -),

- when NEQ solutions inversion of free singular equations,
- projection using minimal constraints and rejection of perturbing stations,
- weekly comparison with ITRF2005 at epoch of each solution,
- analysis and rejection of high residual stations.

The following figure is an example of a SINEX series evaluation that shows significant improvements in dynamical modelling.

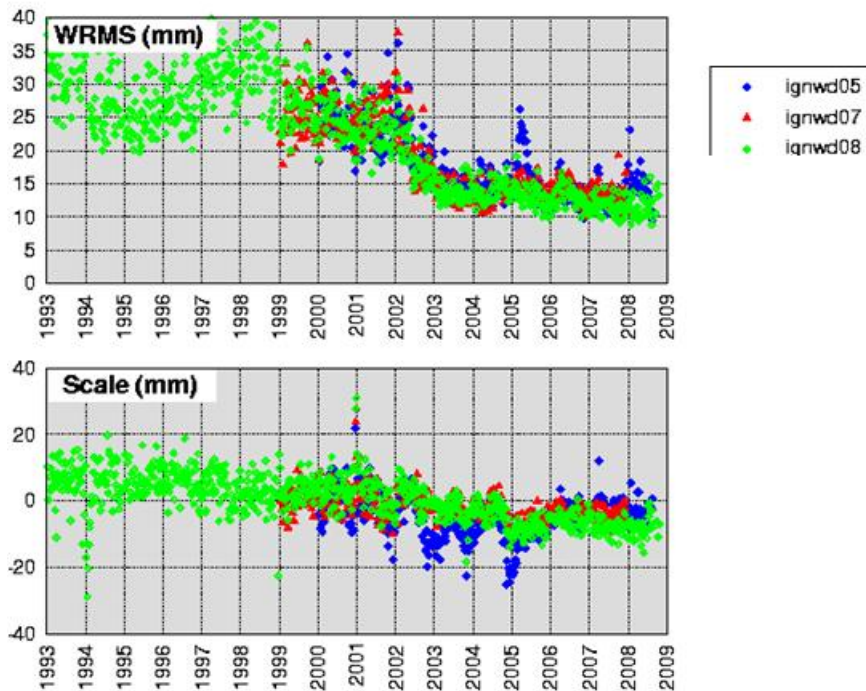

Figure 16 Example of validation of three IGN/IPGP series with successive model improvements (solar radiation pressure, Earth gravity fields, etc.)

A combination web page has been added to the <http://ids.cls.fr> official IDS Internet site. Each analyst can see the results of the validation including a summary report and the plots of the TRF parameters versus ITRF2005 or an internal IDS cumulative position and velocity solution that has been generated for internal use. This solution is also used to complete comparison for new stations of the network knowing that only approximately 20 stations over 50 are still common with ITRF2005 in 2008.

10.3 CONTRIBUTION TO ITRF2008

The following table summarizes the IDS Analysis Centers contribution to ITRF2008 at least for the IDS-1 preliminary solution. One can see that seven AC's participating operating four different orbit programs are involved. The data span covers nearly the full DORIS mission data since 1993. All satellites are generally processed except Jason-1, for which the USO is known to be affected by radiation while crossing the South Atlantic Anomaly. For Jason-1, it was decided to restrict the processing to 2002 before the effects becomes significant especially for equatorial station positioning and difficult to correct even with the empirical DORIS dedicated model.

| AC | Series Id. | Software | Series Id. | Data span | Years |
|-----------------------------|------------|------------------|------------|---|-----------|
| CNES/LCA | lcawd20 | GINS/DYNAMO | wd20 | 1993-1998.4 1999.4-2002 2002-2008 | 15 |
| Pecny Observatory | gopwd31 | BERNESE 5.0 | wd31 | 1998-2008 | 10 |
| INASAN | inawd03 | GYPHY/OASIS 4.03 | wd03 | 1997-2008 | 11 |
| ESA/ESOC | esawd01 | NAPEOS | wd01 | 1993-2008 | 15 |
| IGN/IPGP | ignwd08 | GYPHY/OASIS 5.0 | wd08 | 1993-2008 | 1993-2008 |
| Geoscience Australia | gauwd06 | GEODYN | wd06 | 2003-2008 | 2003-2008 |
| GSFC | gscwd06 | GEODYN | wd06 | 2003-2008 | 2003-2008 |

Table 10 Analysis Centers contribution to ITRF2008 at least for the IDS-1 preliminary solution.

The strategy that was used to generate the weekly combination is to apply minimum constraints to all TRF parameters of the series except for GSFC and Geoscience Australia that shown a scale offset. For those two series, the scale was estimated. From the hereafter plot one can see that the WRMS of the combination drops down for all AC's around 10-20 mm as soon as the number of DORIS satellites constellation is higher than 4 practically after 2002.

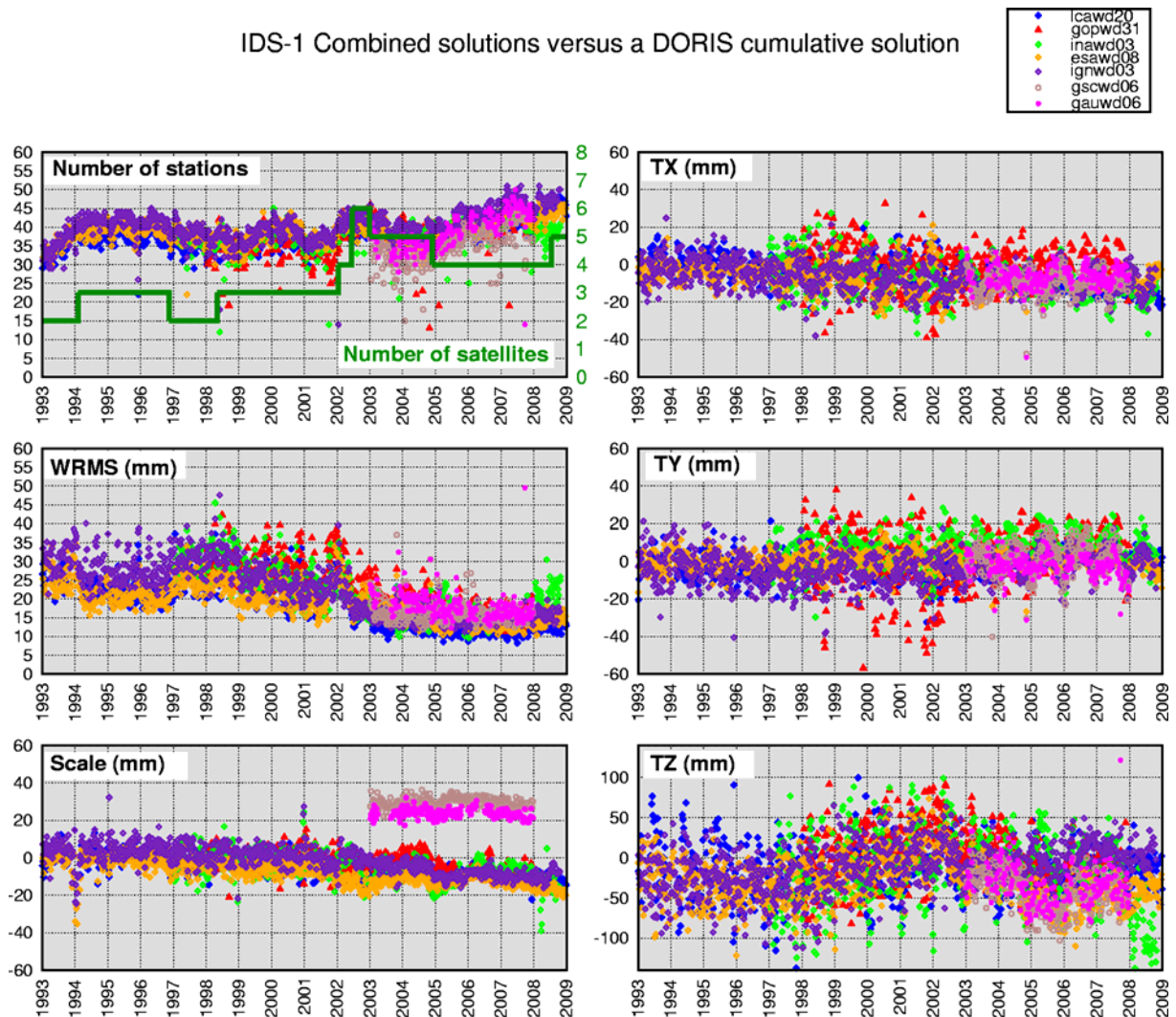

Figure 17 IDS-1 combined solutions versus DORIS cumulative solution

The comparison of the preliminary IDS-1 weekly combined solution versus to ITRF2005 or versus to the internal cumulative solution shows a very nice behavior of TX/TY (between +/- 15mm) and also of the scale, which is comparable to SLR in dispersion and tendency. More detailed results have been presented to EGU2009, Vienna, April 2009.

10.4 JASON-2

Preliminary encouraging results have been obtained with the use of Jason-2 new satellite by ESA/ESOC or CNES/CLS. The new DORIS instrument is able to get data from seven stations at a same time and provides each day an amount of observations equivalent to all of the other DORIS missions. Moreover, the instrument provides phase observations in addition to Doppler observations that are available in a RINEX.

10.5 FUTURE COMBINATIONS

The main combination objective for 2008 focused on ITRF2008 contribution is nearly achieved. Some technical points in the DORIS analysis are still to be issued (see AGW meetings presentations online). Concerning the near and mid-term future of the combination, the priorities are the follows (TBC):

- to include Newcastle University as a new AC as soon as the constraints in the solutions are handled,
- to implement an operational combination that could be based on monthly runs within three months after the data acquisition,
- to deliver combination products such as stations time series.

The last objective supposes that the AC's get ready for regular production.

11 REPORT OF THE ESA/ESOC ANALYSIS CENTER (ESA)

Michiel Otten (1), John Dow (1)

(1) European Space Operation Centre, Darmstadt, Germany.

11.1 INTRODUCTION.

The Navigation Support Office of the European Space Operation Centre (ESOC) has been involved in routine processing of ENVISAT DORIS data since the launch of ENVISAT in 2002. Through this activity ESOC has been involved in the IDS since its start in 2003 having provided ENVISAT Precise Orbits for validation purposes and participating in the various IDS meetings.

With the ITRF-2008 call for participation ESOC decided to participate in all three geodetic satellite tracking techniques: IGS, ILRS and IDS. This led to ESOC becoming a full Analysis Centre for the IDS. This report gives an overview of the various activities ESOC has performed from 2006-2008 focusing on the ITRF-2008 activities.

11.2 ITRF-2008 ACTIVITIES.

The Navigation Support Office at ESOC uses a common software package for all its activities called NAPEOS. This software package has been used since the launch of ENVISAT for the ENVISAT Precise Orbit activities and for generating the IDS contribution to ITRF-2008. The table below gives an overview of the models and standards used for the ITRF contribution:

ITRF-2008 Models and Parameters

| | |
|-------------------------------------|--|
| Software | NAPEOS version 3.2 |
| SINEX Method | NEQ |
| Satellites used | All (SPOT-2,3,4,5 ; T/P ; Jason-1/2 ; ENVISAT |
| Arc length | 1-Day arcs |
| Handle of Manoeuvres | ENVISAT estimated, others excluded from daily solution |
| Handle of data lack | Excluded on the daily level if none/few observations present |
| Reference System | |
| polar motion and UT1 | IERS bulletin A with IERS 2003 daily and sub daily corrections |
| stations coordinates | DPOD-2005 (v1.4) |
| Disp. of Reference Points | |
| Earth tides | IERS-2003 Standards |
| Atmospheric loading | NONE |
| Ocean loading | IERS-2003 Standards |
| Pole tides | IERS-2003 Standards |
| satellite reference | Post-Launch value of Mass, attitude model: Theoretical attitude model (yaw-steering) |
| Gravity | |
| Gravity field (static) | EIGEN-GL05C |
| Gravity field (time varying) | Only C21 & S21 values and rates taken from IERS-2003 standards |
| Earth tides | IERS-2003 Standards |
| Pole tide | IERS-2003 Standards |
| Ocean tides | FES-2004 all const. up to degree/order 50 |
| Atmospheric tides | AGRA 6-hourly fields up to degree/order 20 |
| Third bodies | All planets, Sun and Moon DE-405 |
| Surface forces and empirical | |
| Radiation pressure model | Box-wing model except ENVISAT: ANGARA |
| Radiation pressure coeff. | Fixed |
| Earth radiation | Applied (albedo and IR) |
| Atmospheric density model | MSIS-90 |
| Drag coefficients | 10 per day for SPOT and ENVISAT, 4 per day for T/P and Jason-1/2 |
| 1/rev empiricals | 1 Set per day in along and cross track direction |

Table 11 ESOC standards and models used for ITRF-2008

The ESOC solution submitted to the IDS covers the period from January 1993 until January 2009. Daily normal equation (NEQ) solutions are generated free of any constrains that include all the estimated parameters including the following ITRF parameters: Station coordinates, one set of EOP values (offsets and rates) and LOD. The weekly SINEX solutions are generated by stacking 7-daily solutions together on the normal equation level. From each daily solution the none ITRF parameters are rigorously eliminated (for the satellite drag and CPR parameters

constraints are applied when eliminating them). The resulting SINEX file contains thus the ITRF parameters free of any constrain. The daily normal equation files are saved and different elimination strategies can be used without having to regenerate the daily solutions.

The Figure below shows the comparison of the weekly ESOC solution (esawd03) against the IDS-1 weekly combination.

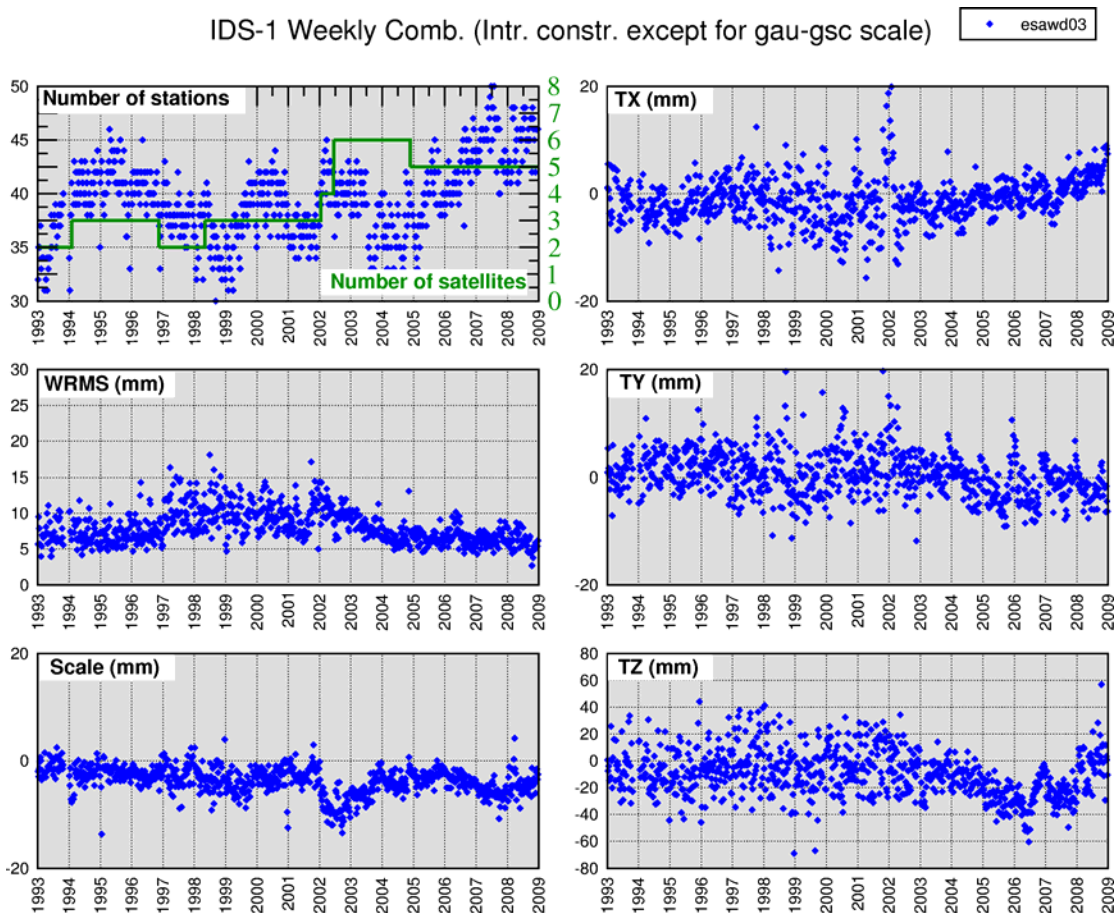

Table 12 Comparison of the ESOC weekly solution against the IDS-1 weekly combination

11.3 FUTURE ACTIVITIES

The Navigation Support Office plans for 2009 to start routine weekly SINEX delivery to the IDS. Further we will keep on supporting the various satellite altimeter missions with a DORIS instrument onboard by providing precise orbit solutions for validation and calibration purposes.

12 REPORT OF THE GEOSCIENCE AUSTRALIA ANALYSIS CENTER (GAU)

Ramesh GOVIND (1)

(1) Geoscience Australia . Canberra, Australia.

12.1 INTRODUCTION:

The main analysis activity during this period was aimed at fulfilling the requirements of an IDS Analysis Centre and to make a substantial DORIS contribution to the ITRF2008. In this regard, the tasks undertaken were DORIS data processing between 2000 and 2008, a comparison of orbit trajectories with the Goddard Space Centre (GSFC) DORIS Analysis Centre, a comparison of DORIS determined orbit trajectories with SLR data, provision of multi-satellite SINEX solutions and submitting the IDS AWG benchmark tests. The IDS analysis activity at Geoscience Australia is undertaken in collaboration with the GSFC Analysis centre.

12.2 DATA PROCESSING

The following data sets were processed in weekly arcs:

| | |
|---------------|------------------|
| SPOT-2 | 000102 – 081227 |
| SPOT-4 | 000102 – 081227 |
| SPOT-5 | 020616 - 081227 |
| Jason-1 | 020324 – 081227 |
| ENVISAT | 020623 – 081227 |
| Jason-1 (SLR) | 020106 – 081227 |
| ENVISAT(SLR) | 020623 - 0801227 |

The computation standards, using the NASA/GSFC Geodyn0712/Solve software suite are described in <ftp://ftp.cls.fr/pub/ids/combinations/ITRF2008-IDS/gauwd06.snxDsc> and ftp://ftp.cls.fr/pub/ids/centers/Template_analysis_summary.xls. The satellite specific macro-model for Solar Radiation Pressure (SRP) and satellite mass changes and satellite centre of mass offset changes applied as per http://ids.cls.fr/html/analysis_coord/documents.html. The current processing applied the ground and spacecraft antenna offset values in the distributed DORIS data files.

12.3 ORBIT COMPARISON TESTS

A series of orbit comparisons were undertaken between Geoscience Australia (GAU) and GSFC. As examples, a comparison of all 2005 weekly arcs for five satellites (SPOT-2, SPOT-4, SPOT-5, ENVISAT and Jason-1) resulted in a maximum mean of the differences in the weekly arcs of -6.5 mm along track for Jason-1, with an RMS of 10 mm. Similarly, a comparison of the trajectories for four satellites (with Jason-1) showed mean differences that ranged from 2-12 mm radial, 10-20 mm cross-track and 10-30 mm along-track. These comparisons validated the computation standards at both GDFC and GAU. Orbit comparisons between the two analysis centers are ongoing. In addition, as a further validation of the orbit computations, Jason-1 and ENVISAT, SLR data was passed through the DORIS determined orbits for the respective satellites. For 63 arcs for ENVISAT during 2006, the mean of the SLR data fits to the DORIS orbits was 19 mm and similarly, 18 mm for 28 arcs during 2007. For the period 060122 – 070624 (maneuvers excluded), the largest mean difference in the orbit components was 14 mm with a RMS with respect to the mean difference of 24 mm in the along track component.

12.4 SINEX SUBMISSIONS

As a contribution to the IDS submission to the ITRF2008, weekly SINEX files for the period starting mid June 2002 to end 2008 have been provided to the IDS combination centre and have been included in the preliminary IDS weekly combination for ITRF2008. A further set for the period 2000 – mid 2002 is in preparation.

12.5 BENCHMARK TESTS.

The first benchmark tests for the period December 1994 were completed and submitted.

13 REPORT OF THE GEODETICAL OBSERVATORY PECNY ANALYSIS CENTER (GOP)

Petr Stepanek (1)

(1). Geodesy Observatory Pecný, Research Institute of Geodesy, Czech Republic

13.1 INTRODUCTION

The DORIS data processing at Geodetic Observatory Pecny (GOP) is based on a GPS-like approach, realized by specifically modified version of Bernese GPS software. The software development started in cooperation of University of Bern, IGN and Czech Technical University around 2002, but almost all the more recent modifications were realized at GOP. The analytical center had started to operate at the testing level; its status has changed at the end of 2007, when GOP was accepted as an operational analysis center. Criteria of the acceptance, prepared by IDS, were based on a comparison of the estimated network in 2005 and the estimated orbits in January 2005. These GOP testing results showed comparable precision of the GOP and the other analysis centers.

13.2 ANALYSIS STRATEGY AND MODELS

The processing strategy is based on a 'pseudo-range difference' processing, when the range rate measurements are transformed into pseudo-range differences using simple multiplication by the length of the observation interval. In the first step (observation level), all satellites are processed separately within individual daily sessions. The single-satellite normal equations are combined at the second step to create a multi-satellite weekly solution. The main DORIS application at GOP is determination of the loosely constrained weekly solutions. The adjusted parameters include the station coordinates, pole coordinates, orbit parameters, troposphere zenith path delays, and the beacon signal frequency offsets at 2 GHz. The station and pole coordinates are weakly constrained (10 m, Pole 500 mas). X-pole and Y-pole noon value and daily rate are currently estimated without continual constraints. UT1-UTC rate is fixed to the IERS C04 values. The orbit, troposphere, and beacon frequency parameters were pre-eliminated to reduce the number of the estimated parameters. The weekly solutions thus provide station coordinates and pole parameters.

Many of the models were updated during 2008 to follow the IDS and IERS proposals. The Saastamoinen troposphere model with Niell mapping function was changed into GPT model with GMF mapping function. A static gravity field was substituted by dynamical EIGEN with harmonics and drifts for chosen geopotential coefficients with additional atmosphere gravity application. FES 2004 model is currently applied for the ocean tidal loading. The orbit modelling

doesn't include exact models for non-conservative forces. The orbits are modelled with six Kepler elements as well as with nine empirical parameters (Sun-satellite direction constant and harmonics, Y-bias, Y-harmonics) with loose constraints ($1 \times 10^{-6} \text{ ms}^{-2}$). Remaining model deficiencies are mitigated by estimating stochastic parameters in the along-track direction at intervals of 15 minutes with constraints of $6 \times 10^{-5} \text{ ms}^{-1}$. The constraints on the stochastic parameters were adapted such that the difference of the estimated orbits to the POE precise orbits was minimized. No air drag parameters are estimated. The orbit model for the one-day arcs includes global gravity field up to degree and order of 100, third body perturbations (Moon, Sun, major planets), solid Earth tides model from IERS 2003, and the OT_CSRC 3.0 ocean tide model.

13.3 AUTOMATION

The automation of the Bernese 5.0 processing (BPE) allows a predefined sequence of Bernese programs to be run with automatic setting of the session dependent variables. This highly modifiable system was extended to manage further settings, dependent only on the session and the processed satellite. The BPE extension enables to modify wide set of values, like satellite-dependent parameters of orbit estimation or non-self-explanatory input filenames. Additionally, it checks availability of data, satellite maneuvers and other conditions that may lead to skipping of the epoch. The most complex changes of BPE were carried out by extension of standard scripts calling particular Bernese programs. Many processing options, defined by fields in input panels, are set in dependency by control variable.

13.4 RESULTS AND PRODUCTS

Data of ten years (1998-2007) were processed and the corresponding weekly SINEX files were delivered to CDDIS data center, as the first official GOP product, marked as solution 31. The processing of so longer data series in 2008 is a very important step of the analysis center evolution (see fig. 18). The repeatability of weekly estimated coordinates was 2-3 cm. A very satisfying precision was achieved in the pole coordinates estimation, where the RMS of the estimated noon coordinates, with respect to IERS C04, achieved 0.5 mas. The orbits were determined with station coordinates constrained to their ITRF2005 values for every day of January 2005 and then compared to LCA (LEGOS/CLS) precise orbits. The RMS differences of the GOP solutions compared to POE orbits exhibit around 2 cm (SPOT-5 1.5 cm) in the radial direction; the mean of 0.2 to 0.6 cm depends on the satellite. Another application is a comparison of ZTD delay estimated by DORIS and GNSS on collocated sites. All the results were presented at IDS DORIS workshop 2008 in Nice.

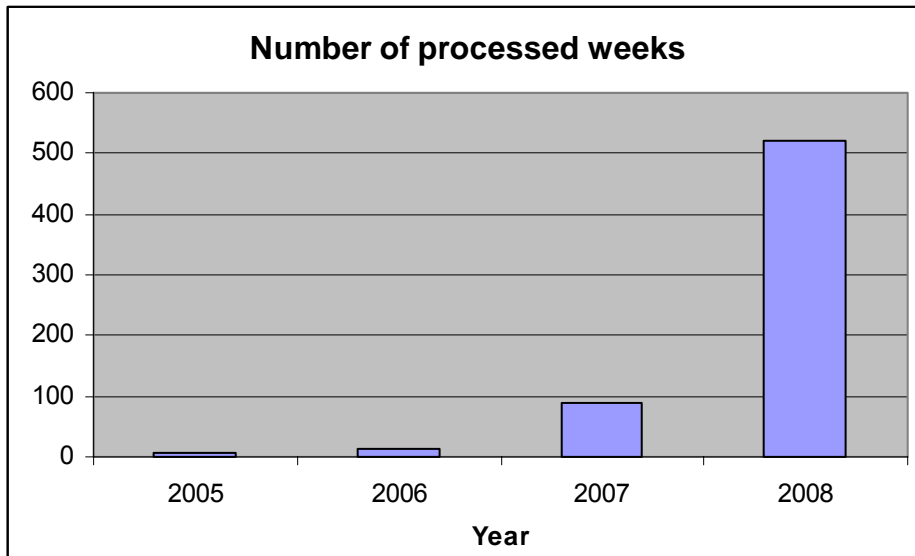

Figure 18 Number of processed weekly solutions during last four years

14 REPORT OF THE NASA/GSFC ANALYSIS CENTER (GSC)

Frank G. Lemoine(1), Nikita P. Zelensky(2), Karine Le Bail(1), Douglas S. Chinn(2)

(1) GSFC/NASA, USA

(2) SGT/NASA, USA

The activities in this time period have included (1) the validation and testing of the ITRF2005 solution; (2) The determination of the impact of the new reference frame, ITRF2005, on the rate sea level change (compared to the previous reference frames of CSR95 and ITRF2000); (3) The complete reprocessing of the TOPEX/Poseidon and Jason-1 times series using updated standards; (4) The development of the GSFC contribution to ITRF2008.

14.1 ITRF2005 & SAA MODEL TESTING AND VALIDATION

The GSFC team participated in the extensive evaluations of the ITRF2005 solution, analyzing both the SLR and DORIS complements. In Table 13 (derived from *Beckley et al. (2007)* and the GSFC presentation at the 2007 Ocean Surface Topography Science Team Meeting, we summarize the orbit determination results on Jason-1 using ITRF2000, ITRF2005, ITRF2005 (rescaled – which affects only the SLR stations) and the SAA correction model (*Lemoine and Capdeville, 2006*). The application of the SAA model significantly improves the Jason-1 orbit quality, as measured by the SLR fits and the independent altimeter crossover residuals. The effect of rescaling the SLR stations made the SLR frame more compatible with the SLR data, removing a mean in the SLR residuals (which was reduced from 0.257 m with ITRF2005 and - 0.03 cm with ITRF2005 rescaled). The rescaling of the SLR stations had no effect on the DORIS complement, which was not affected by the ITRF2005 SLR scale issue.

| Jason SLR/DORIS Orbits (Cycles 1- 177) | Average RMS Residuals | | |
|--|-----------------------|-------------|----------------------|
| | DORIS (mm/s) | SLR (cm) | Crossovers (cm)¶¶ |
| ITRF2000 no SAA | 0.4078 | 1.482 | 5.585 |
| ITRF2000 w. SAA | 0.3740 | 1.440 | 5.578 |
| ITRF2005 w. SAA | 0.3734 | 1.423 | 5.573 |
| ITRF2005 w. SAA (SLR-Rescaled) | 0.3734 | 1.365 | 5.576 |
| ¶¶ Altimeter Crossovers are independent | | | |

Table 13 Jason-1 SLR/DORIS Residuals in tests with ITRF2000 and ITRF2005

14.2 MODEL IMPROVEMENTS FOR ALTIMETER SATELLITE POD

We have also evaluated the impact of model improvements on the altimetric orbit quality. In *Lemoine et al.* (EGU, 2007) we evaluated the impact of different forward models on the Jason-1 orbits. These include the application of atmospheric gravity (using the NCEP-6hr time series prepared by Leonid Petrov at NASA GSFC and available at the URL <http://gemini.gsfc.nasa.gov/agra/>), the application of 20x20 annual variations in the geopotential determined from GRACE (which reflect mainly annual variations in hydrology) (*Luthcke et al.*, 2006). In addition, we examined the impact of forward modelling using ECMWF-3hrs (a more detailed model of atmospheric gravity) and using the GLDAS hydrology model (in lieu of the GRACE annual terms). The GLDAS model (*Rodell et al.*, 2004) has a high temporal and spatial resolution but does not model ice mass variations in the Polar Regions, and does not perfectly describe global hydrology (or else why would we fly the GRACE mission?). The MOG2D ocean barotropic model (*Carrère and Lyard*, 2003) models ocean mass variations. The ECMWF-3hr time series was provided by J.P. Boy (*EOST/IPG, Univ. of Strasbourg, personal communications*, 2007). The results are summarized in Table 14 for Jason-1 cycles 37-111 (January 2003 to January 2005). Both the DORIS and the SLR data were used in the orbit tests, however the altimeter crossovers are considered independent.

| Orbit Series | Description | DORIS (mm/s) | SLR (cm) | Crossover (cm) |
|--------------|---|--------------|----------|----------------|
| notvg | No time-varying gravity | 0.4034 | 1.484 | 5.579 |
| NCEP | Apply NCEP-6hr ATGRAV | 0.4033 | 1.444 | 5.564 |
| Nominal | Apply NCEP-6hr ATGRAV + 20x20 annual geopotential variations from GRACE | 0.4033 | 1.429 | 5.562 |
| MOG2D | Apply ECMWF-3hr ATGRAV + MOG2D barotropic ocean model | 0.4033 | 1.441 | 5.562 |
| GLDAS | Apply MOG2D + GLDAS Hydrology Model | 0.4033 | 1.427 | 5.560 |

Table 14 Jason-1 Orbit Tests with Different Forward Model Improvements

The application of atmospheric gravity provides a significant improvement in the orbit performance removing 4 mm of radial orbit error, as shown by the reduction in variance of the

independent altimeter crossovers. The primary signature of the NCEP-6hr atmospheric gravity on the orbits is shown in **Figure 19**, and is annual variation in the orbits with an amplitude of \pm 5-6 mm. That would be the amplitude of the orbit mismodelling if atmospheric gravity is not modelled which could alias into the station coordinate estimation. The effect on the SPOT and ENVISAT orbits will be larger due to the lower altitude (\sim 800 km) compared to Jason-1 (1336 km).

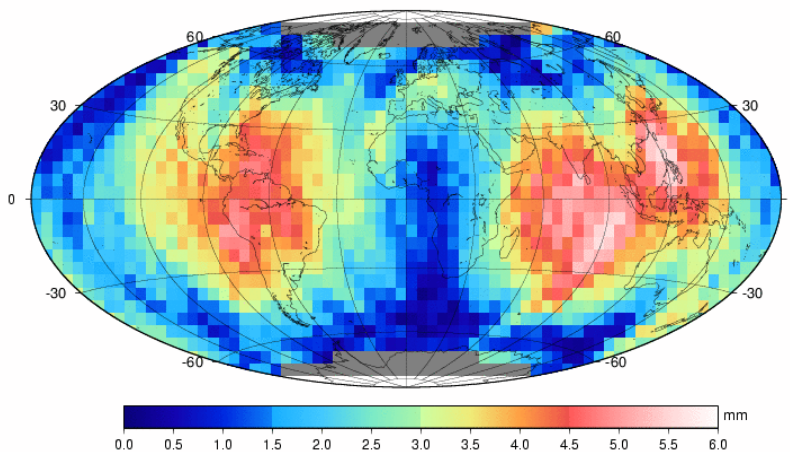

Figure 19 Jason-1 annual radial orbit variation from application of NCEP-6hr atmospheric gravity.

Although the application of the GLDAS hydrology model seems to offer some orbit improvements, the latency of the hydrology model, and the fact that is not available all the way back to 1993 preclude its application for the processing of DORIS data.

14.3 DEFINITION OF AN OPTIMAL ANALYSIS STRATEGY FOR DORIS PROCESSING

We have conducted extensive model tests to ascertain an appropriate strategy for processing of DORIS data. We have examined the impact of elevation cutoffs (5° vs. 10°), static gravity field model, and improved modelling of the surface forces through use of the UCL model for ENVISAT and a tuned macromodel for SPOT-3. The paucity of data below 10° means that the orbit fits for SPOT-2, SPOT-4 and Jason-1 are unaffected. For ENVISAT and SPOT-5, the orbit fits degrade with the inclusion of the lower altitude data (0.45 vs. 0.42 mm/s for SPOT5; 0.57 vs. 0.50 mm/s) for ENVISAT. The caveats to this analysis are that they are conducted using the Hopfield model (both troposphere and mapping function), and no downweighting strategy is applied. The elevation cutoff criterion has little effect on the radial orbit component (an RMS change of less than 0.3 cm is found). However, the cross-track component changes significantly as might be expected. Over the period from 2003 to 2007, the mean RMS cross-track orbit

difference is only 0.3 cm for Jason-1 and SPOT-2, but 1.9 cm for ENVISAT, 1.2 cm for SPOT-5 and 2.3 cm for SPOT-4.

We examined the performance of gravity models on the SPOT-5 orbit, testing the GGM02C, ITG (University of Bonn GRACE solution), EGM2008, and EIGEN-GL04S1 (testing all models to 120x120). We examined the orbit fits, the orbit overlaps, and the empirical accelerations. The GGM02C tests were conducted over the entire period from 2003.0 to 2008.0, whereas the other gravity models were only tested for 2005. The results are summarized in Table 15. The orbital arcs are typically 7 days in length (Sunday 00:00 to Sunday 00:00) but are lengthened by six hours at each end to allow computation of orbit overlaps. The GGM02C gravity field tests used the C_{21} & S_{21} values associated with the model, whereas for the other models, those coefficients were defined according to IERS standards (*McCarthy and Petit, 2004*). Empirical once-per-rev (opr) accelerations along-track and cross track to the orbit are estimated daily, and Table 15 reports the median of the opr daily acceleration amplitudes over the test period.

| Median | RMS of fit (mm/s) | RMS Orbit Overlaps (cm) | | | Empirical Accelerations (m/s ²) | |
|------------------------|----------------------|-------------------------|-------------|-------------|--|-----------------------|
| | | Radial | Cross-track | Along-track | Along-track | Cross-track |
| GGM02C | 0.444 | 0.83 | 9.60 | 5.06 | 2.79×10^{-9} | 1.99×10^{-9} |
| ITG | 0.446 | 0.57 | 3.25 | 2.01 | - | - |
| EIGEN- GL04S1 | 0.446 | 0.61 | 3.28 | 2.02 | 2.74×10^{-9} | 1.56×10^{-9} |
| EGM2008 | 0.446 | 0.55 | 3.25 | 1.92 | 2.81×10^{-9} | 1.64×10^{-9} |
| GGM02C (10° cutoff) | 0.422 | 0.84 | 9.59 | 5.12 | 2.75×10^{-9} | 1.88×10^{-9} |

Table 15 SPOT-5 Orbit Statistics for DORIS Gravity Field Tests

The orbit tests indicate that the EIGEN-GL04S1 gravity is the best model with a notable improvement in the orbit overlaps and the cross-track empirical accelerations. We note that static gravity field model error can alias with troposphere model error, as evidenced by the reduction in the median of the cross-track accelerations for the 10° elevation cutoff test with GGM02C.

We have conducted tests on the ENVISAT to test the implementation of the UCL (University College London) model for the spacecraft (*Ziebart et al., 2005; Sibthorpe, 2006*). The implementation is compared to the standard macromodel for the spacecraft. We examined the DORIS-only ENVISAT orbits from 2003.0 to 2008.0, computing orbits with both models. The mean RMS of fit is reduced from 0.5714 mm/s for the macromodel case to 0.5706 mm/s for the UCL case. The median amplitude of the estimated along-track opr's is reduced from 3.75×10^{-8} m/s² with the macromodel to 0.99×10^{-9} m/s with the UCL model; The median amplitude of the estimated cross-track opr's is reduced from 5.93×10^{-9} m/s² with the macromodel to 3.06×10^{-9} m/s² with the UCL model. We note that the empirical along-track accelerations are sometimes 2X higher in 2003 (and that there is an evident periodicity apparently associated with the rotation of the Sun) than in subsequent years, indicating the importance of atmospheric drag and its effects on the ENVISAT orbit.

In Figure 20, we depict the RMS of fit from processing data from DORIS satellites from 2003.0 to 2008.0.

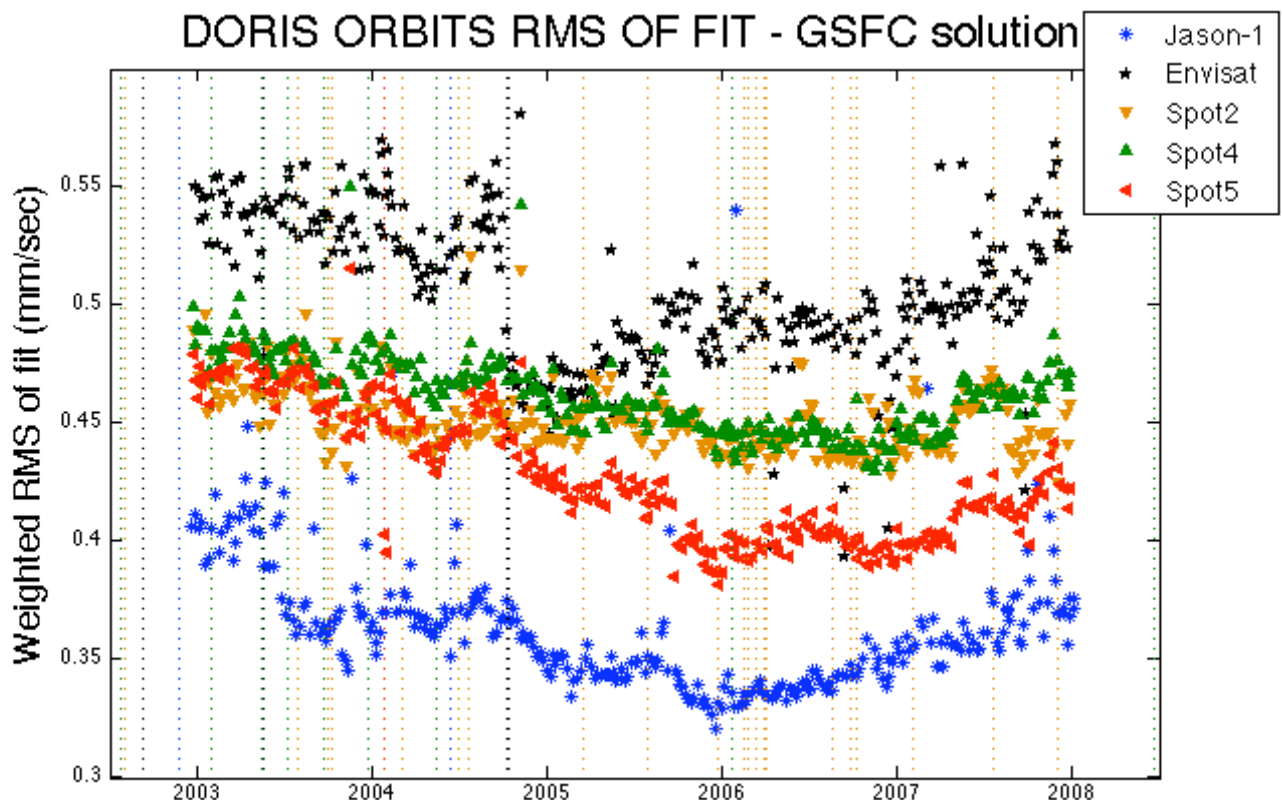

Figure 20 NASA GSFC DORIS orbits RMS of fit (mm/s) for DORIS satellites. The orbital arcs are typically seven days and the base gravity model is GGM02C.

The models applied to obtain the results depicted in Figure 20 included GGM02C (static gravity), Grace-derived annual gravity variations to 20x20, GOT00 Ocean Tide Model, GOT00 Associated Ocean Loading, NCEP-6hr Atmospheric Gravity, MSIS86 for Atmospheric Density, a parameterization of cd/8-hrs for Jason-1 and generally cd/8 hrs for SPOT-2, and cd/6 hrs for SPOT-4, SPOT-5 and ENVISAT. Test SINEX files were constructed and submitted to the IDS combination center for testing. The tests revealed a scale offset with respect to ITRF2005 of +2 cm, which we ultimately found was related to the use of the a priori DORIS-data-supplied meteorological data instead of the GPT model of Johannes Boehm (*Boehm et al., 2007*), as well the use of an older troposphere mapping function, rather than a more up-to-date mapping function.

To resolve some of these issues, and to differentiate ourselves from the GAU Analysis Center we settled on the following model updates for the final ITRF2008 submission. The differences between the final results presented at the IDS Workshop in November 2008 are listed in Table 16.

| Model | November 2008 IDS Workshop (Initial Tests) | Final ITRF2008 Submission |
|-----------------------|---|--|
| Static Gravity | GGM02C (120x120) | EIGEN-GL04S1 (120x120) |
| Atmospheric Gravity | NCEP-6hr | ECMWF-6hr |
| C21/S21 | From GG0M2C | IERS Standards |
| Ocean Tides | GOT00 | GOT4.7 |
| Ocean Loading | GOT00 | GOT4.7 |
| Elevation Cutoff | 5° | 10° |
| Drag Parameterization | Cd/6-hrs to Cd/8-hrs | Cd/2-hrs ($\sigma=1.0$) (ENVISAT & SPOT's) Cd/8-hrs (TOPEX/Poseidon) |
| Macromodels | CNES for SPOT-4/SPOT5; Modified GSFC for SPOT-2, 3 CNES for ENVISAT | TOPEX, SPOT-2, SPOT-4, SPOT-5 macromodels re-tuned; For ENVISAT use UCL model Cr=1.0 |
| Station Coordinates | ITRF2005+IGN | DPOD2005 |
| A priori Met. Data | DORIS data files | GPT |
| Mapping Function | Hopfield | Neill |

Table 16 GSC Analysis DORIS data Processing Standards for ITRF2008

14.4 OTHER ANALYSIS CENTER ACTIVITIES IN 2008

- Testing of the DPOD2005 complement (*Willis et al., 2009*).
- Processing of the first data from Jason-2.
- Testing of the Jason-1 UCL model and a tuned CNES macromodel.
- Reprocessing of the TOPEX/Poseidon SLR/DORIS data (1992-2005) with updated force modelling and the LPOD (SLR) and DPOD2005 (DORIS) station complements.

15 REPORT OF THE IGN/JPL ANALYSIS CENTER (IGN)

Pascal Willis (1)(2), Yoaz E. Bar-Sever (3), M.L. Gobinddass (1)(2), B. Garayt (2)

(1) Institut Géographique National, France

(2) Institut de Physique du Globe de Paris, France

(3) Jet Propulsion Laboratory, California Institute of Technology, USA

15.1 CONTEXT

IGN is using the GIPSY/OASIS (GOA) software package to generate all possible DORIS products for geodetic and geophysical applications. Computations are done automatically, as soon as the last DORIS data is available, using a cron command (Linux environment). Internal validation of results is done through an internal Web site and products are delivered automatically at IGN and CDDIS data centers.

15.2 PRODUCTS DELIVERED (2006-2008)

IGN/JPL generates station free-network solution at a weekly basis in SINEX format at both IGN and CDDIS data centers. From these solutions, computed about 48 hour after the last DORIS data availability, several other products are generated.

ignwd05 is the solution computed as submission to ITRF2005; a derived solution (projected and transformed into ITRF2005 is also available = ignwd06). More recently, following the recent development related to solar radiation pressure modelling (see after) a test solution was submitted (only in free-network) as an intermediary solution before ITRF2008.

From ignwd06 solutions were derived the other geodetic products (STCD = station coordinates differences, geocenter, Earth Orientation parameters, cumulative solution = positions and velocities estimated through the complete observation period.

| Product | Latest version | Update | Data span | files |
|---------------------|----------------|------------|-------------------|-------|
| Weekly SINEX | | | | |
| - free-network | ignwd05 | Weekly | 1993.00 – 2008.67 | 817 |
| - free-network | ignwd07 | Weekly | 1993.00 – 2007.96 | 735 |
| - ITRF2005 | ignwd06 | Weekly | 1993.00 – 2008.67 | 817 |
| STCD | ign07wd01 | Weekly | 1993.00 – 2009.67 | 287 |
| Geocenter | ign07wd01 | Weekly | 1993.00 – 2009.67 | 1 |
| EOP | ign07wd01 | Weekly | 1993.00 – 2009.67 | 1 |
| Cumulative solution | ign07wd02 | 1 per year | 1993.00 – 2007.00 | 1 |
| Orbits | | | | |
| ENVISAT | 3 (*) | on request | 2002.31 – 2008.87 | 2244 |
| Jason-1 | - | - | | |
| SPOT2 | 3 (*) | on request | 1993.00 – 2008.00 | 5257 |
| SPOT3 | 2 (*) | on request | 1994.10 – 1994.87 | 972 |
| SPOT4 | 4 (*) | on request | 1999.00 – 2008.84 | 3509 |
| SPOT5 | 4 (*) | on request | 2002.44 – 2008.87 | 2303 |
| TOPEX | 6 (*) | on request | 1993.00 – 2004.84 | 4163 |

Table 17 IGN/JPL DORIS products delivered during 2006-2008. Products marked with an asterisk (orbits) were delivered but are not currently available by anonymous ftp in the public area. As in January 2009.

Finally for test purposes, a complete time series of all available DORIS satellites (except Jason-1 and Jason-2) were generated in sp3 format, using a new data processing strategy, as will be later used for submission to ITRF2008.

15.3 MAJOR IMPROVEMENTS

ignwd05 and ignwd07 was using GGM01 gravity field. ignwd08 (in preparation) will be using the more recent GGM03 gravity field

The only difference between ignwd05 and ignwd07 is that we are estimating daily solar radiation pressure coefficients in the first one, while ignwd07 is using fixed values for these parameters (previously estimated over long observation period; see *Gobinddass et al., J Geod, 2009*).

A complete recomputation of all DORIS data (ignwd08) was done and will be submitted in early February, using more recent analysis strategy: GGM03 gravity field, fixed SRP coefficients, GMF tropospheric mapping function, 1hr atmospheric drag estimation,... This solution was done in view of ITRF2008, using GOA 5.0 (rootless) version.

16 REPORT OF THE INASAN ANALYSIS CENTER (INA)

Sergey Kuzin, Suriya Tatevian (1)

(1) Institute of Astronomy Russian Academy of Sciences (INASAN), Russia

16.1 INTRODUCTION

In 2006-2008, INASAN (ina) DORIS Analysis Center (AC) continued its activity as a member of the International DORIS Service (IDS). The processing of the DORIS data is performed using the GIPSY/OASIS II software (Linux version 4.03) developed by JPL.

In the computation all available satellites data, except Jason-1 (because of the SAA effect) and SPOT-4 only for 1998 (systematic errors in the Z-geocenter) on the moment of measurements were used. Table 18 summarizes current products delivered by INASAN to the IDS.

| Product | Latest version | Span |
|------------------------------|----------------|-----------------|
| SINEX weekly free-network | inawd03 | 1992.8 - 2009.0 |
| Geocenter | na05wd01 | 1992.8 - 2009.0 |
| EOP-series | ina07wd01 | 1992.8 - 2009.0 |
| STCD-series | ina07wd01 | 1993.0 – 2007.6 |

Table 18 List of INASAN products provided to the IDS (February 2009)

The files of the products description can be found at:

1) SINEX series

ftp://cddis.gsfc.nasa.gov/doris/products/sinex_series/inawd/inawd03.snxdsc

2) geocenter

<ftp://cddis.gsfc.nasa.gov/doris/products/geoc/ina05wd01.geoc.dsc>

3) EOP-series

<ftp://cddis.gsfc.nasa.gov/doris/products/eop/ina07wd01.eop.dsc>

4) STCD-series

<ftp://cddis.gsfc.nasa.gov/doris/products/stcd/ina.stcd.readme>

16.2 PRODUCT AND ANALYSIS RESULTS DESCRIPTIONS.

As a basis of all products, the weekly free-network solutions, obtained after merging daily free-network solutions, have been used. Each SINEX weekly file contains stations coordinates and EOP. After the transformation of free-network solutions into a well-defined reference frame (ITRF2005), the standard deviations of station coordinates were estimated at the level 0.5-4.0 cm, depending on the number of satellites used in the solution. RMS of the X-pole and Y-pole are estimated as 2.83 mas and 1.70 mas, respectively, over 2000-2004 regarding to IERS C04 solution (*D.Gambis, M.Sail, T.Carlucci "Combination of Polar motion parameters series obtained from DORIS", IDS workshop, Venice, 13-15 March 2006*).

Estimated annual geocenter variations for 1993.0-2009.0 were derived by least squares method and evaluated as 6.7±0.2 mm, 5.4±0.1 mm, 28.9±1.1 mm, for X, Y and Z components, respectively (respect to ITRF2005). For the same time period annual geocenter variations of the IGN/JPL DORIS Analysis Center are 6.8±0.2 mm, 6.8±0.1 mm, 27.7±0.8 mm, for X, Y and Z components. Compare to the SLR solution, obtained for the same period, the estimated X and Y components of geocenter variations have slightly higher amplitudes and Z component is considerably higher.

DORIS inter-center orbit comparisons tests (*F.Lemoine et al., <http://ids.cls.fr/html/report/meetings/AWG200803.html>*) showed significant differences of *in* orbits (reaching about 12 cm in along-track direction) compare to another Analysis Centers (especially compare to IGN/JPL AC using the same software GIPSY/OASIS II).

After applying the new satellites macromodels this problem was successfully resolved with overall inter-center orbit consistency at the level 1-2 cm for all directions.

In reply of Action Items List from March 2008 IDS Working Group Meeting in Paris INA AC realized test of SAA model for Jason-1 for two short periods: 2002 (days 15-33) and 2005 (days 2-36). There are no significant improvements from the use of SAA model for weekly positioning solutions for 2002 results, compare to IGN07d02. WRMS were almost the same for each station components. Another result we can see for 2005 period. By the use of SAA model WRMS of stations positions decreases about 2 times, but these results are valid only for the one-month data and subsequent investigations are needed.

The main work for 2006-2008 was connected with preparation and reprocessing DORIS data for all active period of DORIS mission 1993-2008. These reprocessing results will be used as contribution to ITRF2008 solution. INA reprocessed all DORIS data for 1997.0 - 2009.0 (except Jason-1 and SPOT4 only for 1998) and submitted its solutions to the IDS for including in the combined IDS solution. The first preliminary results derived at the IDS Combination Center are promising can be found at http://ids.cls.fr/html/analysis_coord/combination/itrf2008.html

17 REPORT OF THE CNES/CLS ANALYSIS CENTER (LCA)

Laurent Soudarin (1), Hugues Capdeville (1), Jean-Michel Lemoine (2), Jean-François Crétaux(3)

(1) CLS, France

(2) CNES/GRGS Groupe de Recherche en Géodésie Spatiale, France

(3) CNES/LEGOS Laboratoire d'Etudes en Géodésie et Océanographie Spatiales, France

17.1 CONTEXT

The CNES and CLS participate jointly the International DORIS Service (IDS) as an Analysis Center. The processing of the DORIS data is performed using the GINS/DYNAMO software developed by the GRGS.

The CNES team of the LEGOS, who was at the origin of the Analysis Center stopped its participation in 2008. It is now taken over by the CNES team of the GRGS. The Analysis Center, formerly known as the LEGOS/CLS Analysis Center, is now presented as the CNES/CLS Analysis Center. For practical reasons, its acronym stays unchanged: LCA.

The Analysis Center also contributes to the combination activity of the GRGS, which uses the GINS/DYNAMO software package to process observations of the astro-geodetic techniques DORIS, GPS, SLR and VLBI, and to perform the global combination of the geodetic parameters.

The 2006-2008 activities were devoted to the definition of a new analysis strategy and the complete processing of the DORIS data available over 1993-2008.

Series of weekly free-network solutions for station coordinates and pole parameters are delivered to the IDS for the contribution to the ITRF2008 realization.

17.2 DATA PROCESSING

In 2007, the Analysis Center has set up a common processing of the DORIS data in order to respond to IDS and GRGS requests. It is now fitted for a weekly delivery of the products requested by both projects. The data are processed on 3.5-day arcs (between 1 and 3.5 days, depending on maneuvers or other data issues). The arcs are commensurate with the GPS week (Sunday to Sunday). Historically, our group used to process data using a CNES internal format. The processing of this format is now abandoned. Now, we use only the public data available at the IDS Data Centers.

A common set of new modelling standards based on recent models were defined for the processing of the geodetic data in the frame of the GRGS combination activity. The gravity field model EIGEN-GL04S-ANNUAL was chosen (*J.M. Lemoine et al., 2007*). It is formed of a static part up to degree and order 150, and additional time-variable terms for the first degrees (up to degree 50). Those variations include annual, semi-annual and drift terms, based on the GRACE 10-days solutions. (see: <http://bgi.cnes.fr:8110/geoid-variations/README.html>).

We first chose ITRF2005 for the definition of the reference frame, then, in 2008, we adopted DPOD2005 and its associated list of discontinuities and periods to be deleted. Our 6-hr input series of ERP values is obtained by Lagrangian interpolation of the IERS EOP05C04 series.

For the a priori zenithal tropospheric delays, we use the ZTD values computed in the frame of the CNES Jason project by Meteo France from ECMWF meteorological model. Grids of wet and dry ZTD are given every 6h with a resolution of 0.225° . The tropospheric model is completed with the Guo and Langley mapping function.

The GRGS team decided to apply the atmospheric loading correction based on the ECMWF pressure grids in the processing of all the techniques.

For Jason-1, we use the SAA corrective model. The model and the related documentation are available at:

ftp://ftp.cls.fr/pub/ids/satellites/CORRECTIVE_MODEL_JASON1

The version of the GINS software used for the new processing includes a correction of the offset modelling for ENVISAT, which previously induced an anomaly in the early versions of the orbits of this satellite. Model for the new satellite Jason-2 launched in June 2008 was added. Developments were performed to use the new RINEX/DORIS format.

In order to compute orbit overlaps, 3-hour "margins" are now added at the beginning and at the end of the satellite arcs, starting with the arcs after Jan. 1 2006. Note that the "margins" are only used for the orbit computation. Measurements of these 6 additional hours are not taken into account to perform the matrices and solutions of station coordinates and EOP.

While the other analysis centers use the DORIS-data supplied offset, LCA computes and applies its own center of mass and antenna offset corrections to the DORIS data with GINS.

The routine processing started in 2007 was suspended in 2008 to focus on the homogenous re-processing of the whole data set 1993-2008 for the contribution to the ITRF2008.

17.3 PRODUCTS DELIVERED TO IDS

17.3.1 WEEKLY SINEX

See ftp://cddis.gsfc.nasa.gov/pub/doris/products/sinex_series/lca.snx_series.readme

Weekly free-network solutions of station and pole coordinates are generated in the SINEX format. Several series were provided to the IDS during the period 2006-2008. Each submission is an improved version of the previous one. The same loose constraints were applied: 10 meters for the station coordinates, 500 mas for the daily pole coordinates.

lcawd14: SPOT2, SPOT3 or SPOT4, SPOT5, TOPEX and ENVISAT data from January, 3rd 1993 to September, 2nd 2006.

This series was performed in 2006, before the setting up of the new processing and the definition of the new set of models.

lcawd18: SPOT2, SPOT4, SPOT5, and ENVISAT data from January 2005 to April 2008

This series was routinely produced in 2007 with the new processing chain and the new standards. However, the processing configuration was not fixed and was subject to various evolutions.

lcawd20: SPOT2, SPOT3 or SPOT4, SPOT5, TOPEX and ENVISAT data from January, 3rd 1993 to January, 3rd 2009 (series)

This series was produced in the frame of the re-processing for ITRF2008.

The series may be considered as an homogeneous series since the same strategy and the same models are applied for the whole processed period, except that:

1) -before Dec 9th 2001 (until week 1143), dry and wet a priori ZTD are derived from the DORIS meteorological data

-from Dec 9th 2001 (from week 1144), dry and wet a priori ZTD are interpolated from 6-hour grids derived from ECMWF meteorological model.

2) -before July 1st 2000 (until week 1068), albedo and infrared pressure are given from grids of mean monthly values

-from July 1st 2000 (from week 1069), albedo and infrared pressure values are interpolated from 6-hour grids from ECMWF

Compared to the previous series lcawd18, we use DPOD2005 instead of ITRF2005s

17.3.2 WEEKLY COORDINATE TIME SERIES

See <ftp://cddis.gsfc.nasa.gov/pub/doris/products/stcd/lca.stcd.readme>.

Weekly STCD files are also delivered. They give differences of coordinates at the observation epoch. Weekly solutions are performed using minimal constraints and expressed in ITRF2005. The reference positions are given by the ITRF2005 solution.

The files lca07wd01 are derived from the SINEX series lcawd18.

17.3.3 ORBITS

See <ftp://cddis.gsfc.nasa.gov/pub/doris/products/orbits/lca/lca.sp1.readme>

Orbits are delivered to the IDS Data Centers in sp1 format. For ENVISAT, TOPEX/Poseidon, and Jason-2, satellite laser ranging (SLR) data are also used for the orbit determination. These are then DORIS+SLR mixed orbits.

The sp1 series version 02 (ja102, en102, sp202, sp402, sp502, for Jason-1, ENVISAT, SPOT-2, SPOT-4, and SPOT-5) was prepared during the data analysis for the preparation of the lcawd18 SINEX weekly series. The orbits are available only from January 2005 to April 2008.

A new series version 03 (ja203, en103, sp203, sp303, sp403, sp503, top03 for Jason-2, ENVISAT, SPOT-2, SPOT-3, SPOT-4, SPOT-5 and TOPEX/Poseidon) derived from the homogeneous computation of the DORIS data 1993-2008 performed in view of the IDS contribution to the ITRF2008 was made available early 2009.

18 REPORT OF THE NEWCASTLE UNIVERSITY ANALYSIS CENTER (NCL)

Philip Moore (1)

(1) School of Civil Engineering and Geosciences Newcastle University

Recent upgrades to in-house software Faust for DORIS have placed us in a position to begin to contribute on a regular basis to the International DORIS Service. Validation tests are currently ongoing and, with successful completion, the production of regular weekly SINEX solutions for station coordinates and Earth rotation parameters will be implemented. Utilizing the multi-arc multi-satellite capability within Faust, the SINEX files for the SPOT satellites and/or ENVISAT and Jason are computed in a single integrated process. The procedure gives us the capability of unifying parameters such as the wet tropospheric correction across all satellites.

19 REFERENCES

- Altamimi Z, Sillard P, and Boucher C (2002), ITRF2000, A new release of the International Terrestrial Reference Frame for earth science applications. *J Geophys Res, Solid Earth*107(B10):2214, DOI: 10.1029/2001JB000561
- Beckley BD., Lemoine FG, Luthcke SB, Ray RD and NP. Zelensky, A reassessment of global and regional mean sea level trends from TOPEX and Jason-1 altimetry based on revised reference frame and orbits, *Geophys. Res. Lett. Vol. 34, L14608*, doi:10.1029/2007GL030002, 2007
- Beutler G, Rothacher M, Schaer S, Springer TA, Kouba J, Neilan RE (1999), The International GPS Service (IGS), an interdisciplinary service in support of sciences. *Adv Space Res* 23(4):631-653, DOI: 10.1016/S0273-1177(99)00161-1
- Boehm, J., A. Niell, P. Tregoning, and H. Schuh, Global mapping function (GMF): A new empirical mapping function based on numerical weather model data, *Geophys. Res. Lett.*, 33(7), L07304, 2006.
- Boehm, J., Heinemann R, and H. Shuh, Short Note: A global model of pressure and temperature for geodetic applications, *J. Geodesy*, 81(10), pp. 679-683, Oct. 2007
- Carrère L., and F. Lyard, Modelling the barotropic response of the global ocean to atmospheric wind and pressure forcing - comparisons with observations, *Geophys. Res. Lett.*, 30 (6), 1275, doi:10.1029/2002GL016473, 2003.
- Gobinddass, M.L.; Willis, P.; de Viron, O.; Sibthorpe, A.; Zelensky, N.P.; Ries J.C.; Ferland, R.; Bar-Sever, Y.E.; Diament, M., 2009. Systematic biases in DORIS-derived geocenter time series related to solar radiation pressure mis-modeling, *J. Geod.*, DOI: [10.1007/s00190-009-0303-8](https://doi.org/10.1007/s00190-009-0303-8)
- Guo J., Langley R.B., 2003, A new tropospheric propagation delay mapping function for elevation angles down to 2°, ION GPS/GNSS 2003
<http://gauss.gge.unb.ca/papers.pdf/iongpsgnss2003.guo.pdf>,
http://www.ion.org/search/view_abstract.cfm?jp=p&idno=5211
- Haines BJ, Bar-Sever YE, Bertiger WI, Desai S, Willis P (2004), One-Centimeter Orbit Determination for Jason-1, New GPS-Based Strategies. *Marine Geod* 27(1-2):299-318, DOI: 10.1080/01490410490465300
- Lemoine, J.-M., and H. Capdeville, A corrective model for Jason-1 DORIS Doppler data in relation to the South Atlantic anomaly, *J. Geodesy*, 80, pp. 507–523, doi:10.1007/S00190-006-0068-2, 2006.
- Lemoine, J.-M., Bruinsma, S., Loyer, S., Biancale, R., Marty, J.-C., Perosanz, F., Balmino, G., 2007. Temporal gravity field models inferred from GRACE data, *Advances in Space Research* 39 (2007) 1620-1629, doi:10.1016/j.asr.2007.03.062
- Luthcke SB, Zelensky NP, Rowlands DD, Lemoine FG, Williams TA (2003), The 1-Centimeter Orbit: Jason-1 Precision Orbit Determination using GPS, SLR, DORIS and Altimeter Data. *Marine Geod* 26(3-4):399-421
- Luthcke SB, Rowlands DD, Lemoine FG, Klosko SM, Chinn DS, and J.J. McCarthy, Monthly spherical harmonic gravity field solutions determined from GRACE inter-satellite range-rate data alone, *Geophys. Res. Lett.*, 33, doi:10.1029/2005GI024846, 2006.
- McCarthy, D. D., and G. Petit (Eds.), *IERS Conventions*, IERS Tech. Note, vol. 32, Verlag des Bundesamts für Kartogr. und Geod., Frankfurt am Main, Germany, 2004.
- Niell A. E., Global mapping functions for the atmospheric delay at radio wavelengths, *J. Geophys. Res. (Solid Earth)*, 101(B2), pp. 3227-3246, 1996.
- Pearlman MR, Degnan JJ, Bosworth JM (2002), The International Laser Ranging Service. *Adv Space Res* 30(2):135-143, DOI: 10.1016/S0273-1177(02)00277-6
- Petrov L., and J.P. Boy, Study of the atmospheric pressure loading signal in Very Long Baseline Interferometry Observations, *J. Geophys. Res.*, 109, B03405, doi:10.1029/2003JB002500, 2004.

Rothacher M, Dill R, Thaller D (2004), The IERS Combination Pilot Project. First EGU Meeting, Nice, France, April 25-30, 2004, EGU04-A-06622.

Rodell M, Houser PR, Jambor U, Gottschalck J, Mitchell K, Meng CJ, Arsenault K, Cosgrove B, Radakovich J, Bosilovich M, Entin JK, Walker JP, Lohmann D., and D. Toll, The Global Land Data Assimilation System, *Bull. Amer. Meteor. Soc.*,85(3), 381394, 2004.

Rummel R, Rothacher M, Beutler G (2005). Integrated Global Geodetic Observing System (IGGOS), Science rationale. *J Geodyn* 40(4-5):355-356, DOI: 10.1016/j.jog.2005.06.003

Schluter W, Himwich E, Nothnagel A, Vandenberg N, Whitney A (2002), IVS and its important role in the maintenance of the global reference systems. *Adv Space Res* 30(2):145-150, DOI: 10.1016/S0273-1177(02)00278-8

Sibthorpe, A., Precision non-conservative force modelling for low Earth orbiting spacecraft, Ph.D. Thesis, Univ. of London, London, U.K, 2006.

Stepanek P, U. Hugentobler, K. Le Bail (in press) First DORIS data analysis at Geodetic Observatory Pecny. *J Geod DORIS Special Issue*.

Tavernier G, Soudarin L, Larson K, Noll C, Ries J, Willis P (2002), Current status of the DORIS Pilot Experiment and the future International DORIS Service. *Adv Space Res* 30(2):151-156, DOI: 10.1016/S0273-1177(02)00279-X

Tavernier G, Granier JP, Jayles C, Sengenés P, Rozo F (2003), The current evolution of the DORIS system. *Adv Space Res* 31(8):1947-1952, DOI: 10.1016/S0273-1177(03)00155-8

Willis P, Bar-Sever Y, Tavernier G (2005), DORIS as a potential part of a Global Geodetic Observing System, *J Geodyn*, 40(4-5), 494-501, DOI : 10.1016/j.jog.2005.06.011

Willis, P., Haines BJ, Berthias JP, Sengenés P, and J. Le Mouél, Comportement de l'oscillateur DORIS/Jason au passage de l'anomalie sud-atlantique, *C. R. Geoscience*, 336(9), 839 – 846, doi:10.1016/j.crte.2004.01.004, 2004.

Willis, P., J.P. Berthias, and Y.E. Bar-Server, Systematic errors in the Z-geocenter derived using satellite tracking data: a case study from SPOT-4 DORIS data in 1998, *J. Geodesy*, 79(10-11), pp. 567-572, 2006.

Willis, P., Ries JC, Zelensky NP, Soudarin L., Fagard H., Pavlis EC, and F.G. Lemoine, DPOD2005: An extension of ITRF2005 for precise orbit determination, *Advances in Space Research*, 2009.

Ziebart, M., Generalized analytical solar radiation pressure modelling algorithm for spacecraft of complex shape, *J. Spacecraft and Rockets*, 41(5), pp. 840-849, Sep-Oct 2004.

Ziebart, M., S. Adhya, and A. Sibthorpe, Combined radiation pressure and thermal modelling of complex satellites: Algorithms and on-orbit tests, *Advances in Space Research*, 36(3), pp. 424-430, 2005.

20 PUBLICATIONS (2006-2008)

Hera is below the list of DORIS publications in international peer-reviewed journals for 2006-2008. The complete list is available on the IDS web site: http://ids.cls.fr/html/report/peer-reviewed_journals.html

2008

Stamps, DS; Calais, E; Saria, E; Hartnady, C; Nocquet, JM; Ebinger, CJ; Fernandes, RM 2008. A kinematic model for the east African rift, *GEOPHYSICAL RESEARCH LETTERS*, 35(5):L05304, DOI: [10.1029/2007GL032781](https://doi.org/10.1029/2007GL032781)

2007

Altamimi, Z.; Collilieux, X.; Legrand, J.; Garayt, B.; Boucher, C. 2007. ITRF2005, A new release of the International Terrestrial Reference Frame based on time series of station positions and earth orientation parameters, *JOURNAL OF GEOPHYSICAL RESEARCH*, 112(B9), B09401, DOI: [10.1029/2007JB004949](https://doi.org/10.1029/2007JB004949).

Amalvict, M.; Willis, P.; Shibuya, K. 2007. Status of DORIS stations in Antarctica for precise geodesy, in *Dynamic Planet, Monitoring and understanding a dynamic planet with geodetic and oceanographic tools*, P. Tregoning, C. Rizos (Eds.), *IAG SYMPOSIUM*, 130:94-102.

Beckley, BD; Lemoine, FG; Luthcke, SB; Ray, RD; Zelensky, NP 2007. A reassessment of global and regional mean sea level trends from TOPEX and Jason-1 altimetry based on revised reference frame orbits, *GEOPHYSICAL RESEARCH LETTERS*, 34(14), L14608, DOI: [10.1029/2007GL030002](https://doi.org/10.1029/2007GL030002).

Coulot, D.; Berio, P.; Biancale, R.; Loyer, S.; Soudarin, L.; Gontier, A.-M., 2007. Toward a direct combination of space-geodetic techniques at the measurement level: Methodology and main issues, *JOURNAL OF GEOPHYSICAL RESEARCH*, 112(B5), B05410, DOI: [10.1029/2006JB004336](https://doi.org/10.1029/2006JB004336).

Doornbos, E; Willis, P 2007. Analysis of DORIS range-rate residuals for TOPEX/Poseidon, Jason, ENVISAT and SPOT, *ACTA ASTRONAUTICA*, 60(8-9), 611-621, DOI: [10.1016/j.actaastro.2006.07.012](https://doi.org/10.1016/j.actaastro.2006.07.012).

Feissel-Vernier, M.; de Viron, O.; Le Bail, K. 2007. Stability of VLBI, SLR, DORIS and GPS positioning, *Earth Planets and Space* 59(6), 475-497. [See the abstract](#)

Li, F.; Parrot, M. 2007. Study of the TEC data obtained from the DORIS stations in relation to seismic activity, *ANNALS OF GEOPHYSICS*, 50(1), 39-50.

Poretti, G; Mandler, R; Lipizer, M. 2007. The GPS station at the Pyramid geodetic Laboratory. *BOLLETTINO DI GEOFISICA TEORICA ED APPLICATA* 48(1), 25-32.

Willis, P. 2007. Analysis of a possible future degradation of the DORIS results related to changes in the satellite constellation, *Advances in Space Research* 39(10), 1582-1588, DOI: [10.1016/j.asr.2006.11.018](https://doi.org/10.1016/j.asr.2006.11.018)

Willis, P.; Haines, B.J.; Kuang, D. 2007. DORIS satellite phase center determination and consequences on the derived scale of the Terrestrial Reference Frame, *ADVANCES IN SPACE RESEARCH* 39(10), 1589-1596, DOI: [10.1016/j.asr.2007.01.007](https://doi.org/10.1016/j.asr.2007.01.007)

Willis, P.; Lemoine, F.G.; Soudarin, L. 2007. Looking for systematic error in scale from Terrestrial Reference Frame derived from DORIS data, in *Dynamic Planet, Monitoring and understanding a dynamic planet with geodetic and oceanographic tools*, P. Tregoning, C. Rizos (Eds.), *IAG Symp.*, 130:143-151.

Willis, P.; Soudarin, L.; Jayles, C.; Rolland, L. 2007. DORIS applications for Solid Earth and Atmospheric Sciences, *CR GEOSCIENCE*, 339(16), 949-959, DOI: [10.1016/j.crte.2007.09.015](https://doi.org/10.1016/j.crte.2007.09.015)

2006

- Altamimi, Z.; Collilieux, X.; Boucher, C. 2006. DORIS Contribution to ITRF2005, in DORIS Special Issue, P. Willis (Ed.), *JOURNAL OF GEODESY* 80(8-11):625-635, DOI: [10.1007/s00190-006-0065-5](https://doi.org/10.1007/s00190-006-0065-5)
- Bernhardt, PA; Siefiring, CL 2006. New satellite-based systems for ionospheric tomography and scintillation region imaging, *RADIO SCIENCE*, 41 (5): Art. No. RS5S23 JUL 25 2006, DOI: [10.1029/2005RS003360](https://doi.org/10.1029/2005RS003360)
- Bernhardt, P.A.; Siefiring, C.L.; Galysh, I.J.; Rodillo, T.F.; Koch, D.E.; MacDonald, T.L.; Wilkens, R.; Landis, G.P. 2006. Ionospheric applications of the scintillation and tomography receiver in space (CITRIS) mission when used with the DORIS radio beacon network, in DORIS Special Issue, P. Willis (Ed.), *JOURNAL OF GEODESY* 80(8-11):473-485, DOI: [10.1007/s00190-006-0064-6](https://doi.org/10.1007/s00190-006-0064-6)
- Bettinelli, P.; Avouac, J.P.; Flouzat, M.; Jouanne, F.; Bollinger, L.; Willis, P.; Chitrakar, G.R. 2006. Plate Motion of India and Interseismic Strain in the Nepal Himalaya from GPS and DORIS Measurements, in DORIS Special Issue, P. Willis (Ed.), *JOURNAL OF GEODESY* 80(8-11):567-589, DOI: [10.1007/s00190-006-0030-3](https://doi.org/10.1007/s00190-006-0030-3)
- Fagard, H. 2006. Twenty years of evolution for the DORIS permanent network: from its initial deployment to its renovation, in DORIS Special Issue, P. Willis (Ed.), *JOURNAL OF GEODESY* 80(8-11):429-456, DOI: [10.1007/s00190-006-0084-2](https://doi.org/10.1007/s00190-006-0084-2)
- Feissel-Vernier, M.; Le Bail, K.; Beriot, P.; Coulot, D.; Ramillien, G., Valette, J.J. 2006. Geocentre motion measured with DORIS and SLR, and predicted by geophysical models, in DORIS Special Issue, P. Willis (Ed.), *JOURNAL OF GEODESY* 80(8-11):637-648, DOI: [10.1007/s00190-006-0079-z](https://doi.org/10.1007/s00190-006-0079-z)
- Gambis, D. 2006. DORIS and the Determination of the Earth's Polar Motion, in DORIS Special Issue, P. Willis (Ed.), *JOURNAL OF GEODESY* 80(8-11):649-656, DOI: [10.1007/s00190-006-0043-y](https://doi.org/10.1007/s00190-006-0043-y)
- Hanuse, C.; Cerisier, J.C.; Auchere, F.; Bocchialini, K.; Bruinsma, S.; Cornilleau-Wehrin, N., Jakowski, N.; Lathuillere, C.; Menvielle, M.; Valette, J.J.; Vilmer, N.; Watermann, J.; Yaya, P., 2006. From the Sun to the Earth: impact of the 27-28 May 2003 solar events on the magnetosphere, ionosphere and thermosphere, *ANNALES GEOPHYSICAE*, 24(1):129-151.
- Jayles, C.; Nhun-Fat, B.; Tourain, C. 2006. DORIS: System Description and Control of the Signal Integrity, in DORIS Special Issue, P. Willis (Ed.), *JOURNAL OF GEODESY* 80(8-11):457-472, DOI: [10.1007/s00190-006-0046-8](https://doi.org/10.1007/s00190-006-0046-8)
- Le Bail, K. 2006. Estimating the noise in space-geodetic positioning: the case of DORIS, in DORIS Special Issue, P. Willis (Ed.), *JOURNAL OF GEODESY* 80(8-11):541-565, DOI: [10.1007/s00190-006-0088-y](https://doi.org/10.1007/s00190-006-0088-y)
- Lemoine, J.M.; Capdeville, H. 2006. A corrective model for Jason-1 DORIS Doppler data in relation to the South Atlantic Anomaly, in DORIS Special Issue, P. Willis (Ed.), *JOURNAL OF GEODESY* 80(8-11):507-523, DOI: [10.1007/s00190-006-0068-2](https://doi.org/10.1007/s00190-006-0068-2)
- Li, F.; Parrot, M. 2006. Total Electron Content Variations Observed by a DORIS Station During the 2004 Sumatra-Andaman Earthquake, in DORIS Special Issue, P. Willis (Ed.), *JOURNAL OF GEODESY* 80(8-11):487-495, DOI: [10.1007/s00190-006-0053-9](https://doi.org/10.1007/s00190-006-0053-9)
- Noll, C.; Soudarin, L. 2006. On-line Resources Supporting the Data, Products, and Information Infrastructure for the International DORIS Service, in DORIS Special Issue, P. Willis (Ed.), *JOURNAL OF GEODESY* 80(8-11):419-427, DOI: [10.1007/s00190-006-0051-y](https://doi.org/10.1007/s00190-006-0051-y)
- Nocquet, J.M.; Willis, P., Garcia, S. 2006. Plate kinematics of Nubia-Somalia using a combined DORIS and GPS solution, in DORIS Special Issue, P. Willis (Ed.), *JOURNAL OF GEODESY* 80(8-11):591-607, DOI: [10.1007/s00190-006-0078-0](https://doi.org/10.1007/s00190-006-0078-0)
- Snajdrova, K; Boehm, J; Willis, P; Haas, R; Schuh H. 2006. Multi-technique comparison of tropospheric zenith delays derived during the CONT02 campaign, *JOURNAL OF GEODESY* 79(10-11):613-623, DOI: [10.1007/s00190-005-0010-z](https://doi.org/10.1007/s00190-005-0010-z)

Soudarin, L.; Cretaux, J.F. 2006. A model of present-day tectonic plate motions from 12 years of DORIS measurements, in DORIS Special Issue, P. Willis (Ed.), *JOURNAL OF GEODESY* 80(8-11):609-624, DOI: [10.1007/s00190-006-0090-4](https://doi.org/10.1007/s00190-006-0090-4)

Stepanek, P.; Hugentobler, U.; Le Bail, K. 2006. First results of DORIS data analysis at Geodetic Observatory Pecný, in DORIS Special Issue, P. Willis (Ed.), *JOURNAL OF GEODESY* 80(8-11):657-664, DOI: [10.1007/s00190-006-0071-7](https://doi.org/10.1007/s00190-006-0071-7)

Tavernier, G.; Fagard, H.; Feissel-Vernier, M.; Le Bail, K.; Lemoine, F.; Noll, C.; Noomen, R.; Ries, J.C.; Soudarin, L.; Valette, J.J.; Willis, P. 2006. The International DORIS Service: genesis and early achievements, in DORIS Special Issue, P. Willis (Ed.), *JOURNAL OF GEODESY* 80(8-11):403-417, DOI: [10.1007/s00190-006-0082-4](https://doi.org/10.1007/s00190-006-0082-4)

Williams, S.D.P.; Willis, P. 2006. Error Analysis of Weekly Station Coordinates in the DORIS Network, in DORIS Special Issue, P. Willis (Ed.), *JOURNAL OF GEODESY* 80(8-11):525-539, DOI: [10.1007/s00190-006-0056-6](https://doi.org/10.1007/s00190-006-0056-6)

Willis, P.; Berthias, J-P; Bar-Sever, YE. 2006. Systematic errors in the Z-geocenter derived using satellite tracking data, A case study from SPOT-4 DORIS data in 1998, *JOURNAL OF GEODESY* 79(10-11):567-572, DOI: [10.1007/s00190-005-0013-9](https://doi.org/10.1007/s00190-005-0013-9)

Willis, P.; Jayles, C.; Bar-Sever, Y. 2006. DORIS, from altimetric missions orbit determination to geodesy, CR Geoscience, in Special Issue, Observing the Earth from Space, A. Cazenave, C. Boucher (Eds), 338(14-15):968-979, DOI: [10.1016/j.crte.2005.11.013](https://doi.org/10.1016/j.crte.2005.11.013)

Zelensky, N.P.; Berthias, J.P.; Lemoine, F.G. 2006. DORIS time bias estimated using Jason-1, TOPEX/Poseidon and ENVISAT orbits, in DORIS Special Issue, P. Willis (Ed.), *JOURNAL OF GEODESY* 80(8-11):497-506, DOI: [10.1007/s00190-006-0075-3](https://doi.org/10.1007/s00190-006-0075-3)

APPENDIX: DORIS STATIONS COLOCATION WITH TIDE GAUGES

The table and the figure below are courtesy provided by the « Système d'Observation du Niveau des Eaux Littorales » (SONEL, Université de La Rochelle, France). They are regularly updated at the following address : <http://www.sonel.org/stations/cgps/survey/survey.doris.html>

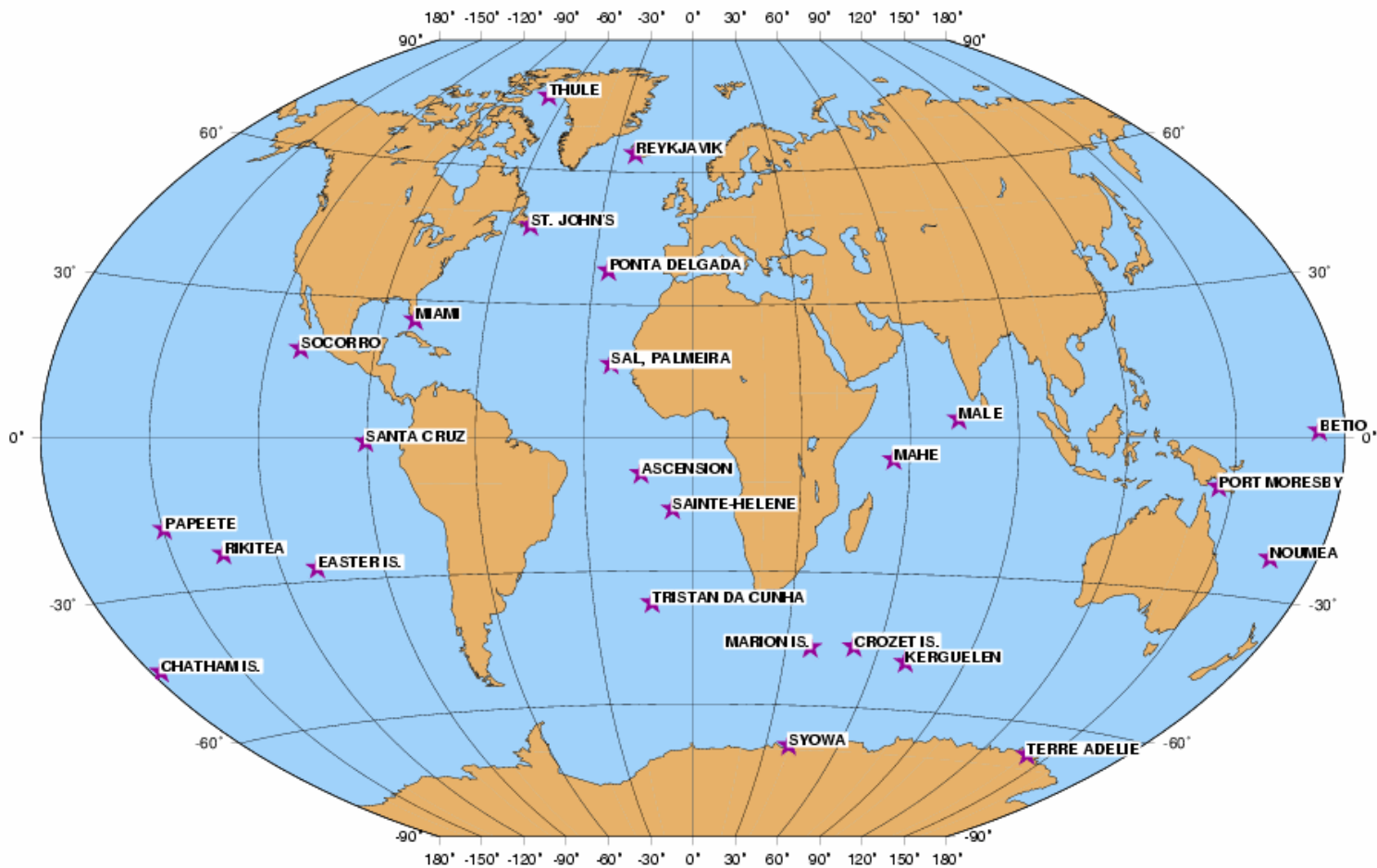

| DORIS Name | Longitude | Latitude | Country | Start date | Distance | GLOSS id | PSMSL id |
|------------------|-----------|----------|------------------------|------------|----------|----------|----------|
| ASCENSION | -14.33 | -7.92 | UK | 1997-02-28 | 6500 | 263 | 402001 |
| BETIO | 172.92 | 1.35 | KIRIBATI | 2006-10-22 | 1600 | 113 | 730009 |
| CHATHAM ISLAND | -176.57 | -43.96 | NEW ZEALAND | 1999-02-28 | 1200 | 128 | ----- |
| COLOMBO | 79.87 | 6.89 | SRI LANKA | 1991-06-06 | 5000 | 033 | 520001 |
| CROZET ISLAND | 51.85 | -46.43 | FRANCE | 2003-12-21 | 850 | 21 | 433001 |
| EASTER ISLAND | -109.38 | -27.15 | CHILI | 1988-11-17 | 7000 | 137 | 810003 |
| KERGUELEN | 70.26 | -49.35 | FRANCE | 1987-01-28 | 3300 | 023 | 434001 |
| MAHE | 55.53 | -4.68 | SEYCHELLES | 2001-06-20 | 300 | 273 | 442007 |
| MALE | 73.53 | 4.20 | MALDIVES | 2005-01-15 | 500 | 28 | 454011 |
| MARION ISLAND | 37.86 | -46.88 | SOUTH AFRICA | 1987-05-15 | 1000 | 020 | ----- |
| MIAMI | -80.17 | 25.73 | USA | 2005-02-10 | 180 | --- | 960001 |
| NOUMEA | 166.41 | -22.27 | FRANCE (CALEDONIA) | 1987-10-20 | 3600 | 123 | 740001 |
| PAPEETE | -149.61 | -17.58 | FRANCE (POLYNESIA) | 1995-07-27 | 7000 | 140 | 780011 |
| PONTA DELGADA | -25.66 | 37.75 | PORTUGAL (AZORES) | 1998-11-02 | 1500 | 245 | 36002 |
| PORT MORESBY | 146.18 | -9.43 | PAPUA NEW GUINEA | 1988-03-29 | 6000 | --- | 670012 |
| REYKJAVIK | -21.99 | 64.15 | ICELAND | 1990-07-04 | 2500 | 229 | 010001 |
| RIKITEA | -134.97 | -23.13 | FRANCE (POLYNESIA) | 2006-09-23 | 800 | 138 | 808001 |
| SAINTE-HELENE | -5.67 | -15.94 | UK | 1989-06-01 | 4000 | 264 | 425001 |
| SAL | -22.98 | 16.78 | CAPE VERDE | 2002-12-15 | 7000 | 329 | 380021 |
| SANTA CRUZ | -90.30 | -0.75 | ECUADOR | 2005-04-01 | 1600 | | 845031 |
| SOCORRO | -110.95 | 18.73 | MEXICO | 1989-06-09 | 400 | 162 | 830062 |
| ST. JOHN'S | -52.68 | 47.40 | CANADA | 1999-09-27 | 4000 | 223 | 970121 |
| SYOWA | 39.58 | -69.01 | JAPAN (ANTARCTICA) | 1993-02-10 | 1000 | 095 | A--041 |
| TERRE ADELIE | 140.00 | -66.67 | FRANCE (ANTARCTICA) | 1987-02-05 | 500 | 131 | ----- |
| THULE | -68.83 | 76.54 | DENMARK (GREENLAND) | 2002-09-28 | 300 | --- | ----- |
| TRISTAN DA CUNHA | -12.31 | -37.07 | UK | 1986-06-10 | 2000 | 266 | ----- |



**INTERNATIONAL
DORIS
SERVICE**

<http://ids.cls.fr>

Contacts

Governing Board

Chairperson: Pascal Willis (IGN/ IPGP) willis@ipgp.jussieu.fr

Central Bureau

Laurent Soudarin (CLS) Laurent.Soudarin@cls.fr

Pascale Ferrage (CNES) pascale.ferrage@cnes.fr

Analysis coordinator

Frank Lemoine (NASA/GSFC) Frank.G.Lemoine@nasa.gov

Data flow coordinator

Carey Noll (NASA/GSFC) Carey.Noll@nasa.gov

Network Manager

Up to 2009: Hervé Fagard (IGN) hervé.fagard@ign.fr

Since 2009: Jérôme Saunier (IGN) jerome.saunier@ign.fr

