



International Doris Service

Activity Report 2011

The International DORIS Service

January 2011 – December 2011 report

P. Ferrage (1), B. Garayt (2), R. Govind (3), S. Kuzin (4), F.G. Lemoine (5), C. Ma (5), G. Moreaux (8), C.E. Noll (5), M. Otten (6), J.C. Ries (7), J. Saunier (2), L. Soudarin (8), P. Stepanek (9), P. Willis (10, 11).

- (1) Centre National d'Etudes Spatiales, 18 Avenue Edouard Belin, 31401 Toulouse Cedex 9, FRANCE
- (2) Institut Géographique National, Service de la Géodesie et du Nivellement, 73, avenue de Paris, 94165 Saint-Mandé Cedex, FRANCE
- (3) Geoscience Australia, Geospatial and Earth Monitoring Division, Dept. of Industry, Tourism, and Resources, GPO Box 378, Canberra, ACT 2601, AUSTRALIA
- (4) Institute of Astronomy, Russian Academy of Sciences, 48, Pyatnitskaya St., Moscow 119017, RUSSIA
- (5) NASA Goddard Space Flight Center, Greenbelt, Maryland, USA
- (6) European Space Agency, European Space Operation Centre, Robert-Bosch-Strasse 5, 64293 Darmstadt, GERMANY
- (7) Center for Space Research, University of Texas, R1000, Austin, TX 78712, USA
- (8) Collecte Localisation Satellites, 8-10, rue Hermès, Parc Technologique du Canal, 31520 Ramonville Saint-Agne, FRANCE
- (9) Geodesy Observatory Pecný, Research Institute of Geodesy, Topography and Cartography, Ondrejov 244, 25165 Prague-East, CZECH REPUBLIC
- (10) Institut Géographique National, Direction Technique, 73, avenue de Paris, 94165 Saint-Mandé, FRANCE
- (11) Institut de Physique du Globe de Paris, UFR STEP / GSP Bat Lamarck Case 7011, 75013 Paris Cedex 13, FRANCE

In this volume, the International DORIS Service documents the work of the IDS components between January 2011 and December 2011. The individual reports were contributed by IDS groups in the international geodetic community who make up the permanent components of IDS.

The IDS 2011 Report describes the history, changes, activities and the progress of the IDS. The Governing Board and Central Bureau kindly thank all IDS team members who contributed to this report.

IDS benefits from this publication to relay the thanks of CNES and IGN towards the whole of the host agencies for their essential contribution with the operation of the DORIS system. The list of the host agencies is given in appendix.

The entire contents of this Report also appear on the IDS website at

http://ids-doris.org/documents/report/IDS_Report_2011.pdf

TABLE OF CONTENTS

TABLE OF CONTENTS.....	3
IDS AND DORIS QUICK REFERENCE LIST.....	5
GLOSSARY.....	8
1 INTRODUCTION.....	15
2 HISTORY.....	16
3 ORGANIZATION.....	18
4 THE CENTRAL BUREAU: IDS INFORMATION SYSTEM.....	20
4.1 SUPPORT TO THE IDS COMPONENTS.....	20
4.2 IDS WEBSITE.....	21
4.3 IDS FTP SERVER.....	21
4.4 FUTURE PLANS.....	22
5 THE NETWORK.....	23
5.1 GENERAL STATUS OF THE NETWORK.....	23
5.2 EVOLUTION AND DEVELOPMENT.....	24
6 THE SATELLITES WITH DORIS RECEIVERS.....	26
7 IDS DATA FLOW COORDINATION.....	30
7.1 INTRODUCTION.....	30
7.2 FLOW OF IDS DATA AND PRODUCTS.....	30
7.3 DORIS DATA.....	32
7.4 DORIS PRODUCTS.....	34
7.5 SUPPLEMENTARY DORIS INFORMATION.....	35
7.6 FUTURE PLANS.....	35
8 IDS DATA CENTERS.....	36
8.1 CRUSTAL DYNAMICS DATA INFORMATION SYSTEM (CDDIS).....	36
8.1.1 FUTURE PLANS.....	36
8.1.2 CONTACT.....	36
8.2 IGN DORIS DATA CENTER.....	37
8.2.1 CONTACT.....	37
9 IDS ANALYSIS COORDINATION.....	38
10 IDS COMBINATION.....	41
10.1ACTIVITY SUMMARY.....	41
10.2IDS ROUTINE COMBINATION.....	41
10.3IDS 2010 CAMPAIGN.....	42
10.4FIRST CRYOSAT-2 ANALYSES.....	43
10.5COMMUNICATIONS.....	43
10.6FUTURE PLANS.....	44
11 REPORT OF THE ESA/ESOC ANALYSIS CENTER (ESA).....	45
11.1INTRODUCTION.....	45
11.2ROUTINE PROCESSING AND THE NEW ESAWD06 SOLUTION.....	45
11.3FUTURE ACTIVITIES.....	46
12 REPORT OF THE GEOSCIENCE AUSTRALIA ANALYSIS CENTER (GAU).....	47

13 REPORT OF THE GEODETICAL OBSERVATORY PECNY	
ANALYSIS CENTER (GOP)	48
13.1ROUTINE DATA PROCESSING	48
13.2DEVELOPMENT OF THE DYNAMICAL ORBITAL MODEL	48
14 REPORT OF THE GSFC/NASA ANALYSIS CENTER (GSC)	50
14.1SINEX SERIES	50
14.2TOPEX, JASON-1, JASON-2 SLR/DORIS POD PROCESSING	52
14.3CRYOSAT-2 PROCESSING SUMMARY	54
15 REPORT OF THE IGN/JPL ANALYSIS CENTER (IGN)	57
15.1CONTEXT	57
15.2PRODUCTS DELIVERED IN 2011	57
15.3MAJOR IMPROVEMENTS IN 2011	58
15.4NEW DEVELOPMENTS	59
16 REPORT OF THE INASAN ANALYSIS CENTER (INA)	60
16.1INTRODUCTION	60
16.2SOFTWARE UPDATE AND ANALYSIS RESULTS DESCRIPTIONS	61
17 REPORT OF THE CNES/CLS ANALYSIS CENTER (LCA)	62
17.1INTRODUCTION	62
17.2DATA PROCESSING AND PRODUCTS DELIVERED TO IDS	62
17.3REPROCESSING	63
17.4CORRECTION AND VALIDATION OF THE ATTITUDE MODELS	64
17.5JASON-2 “TWO- CHANNEL LIKE”	65
17.6PLANS FOR 2012	65
18 REFERENCES	66
19 PUBLICATIONS (2011)	69
APPENDIX 1: THE IDS INFORMATION SYSTEM	70
1 WHAT AND WHERE	70
2 WEB AND FTP SITES	71
2.1 IDS WEBSITE	71
2.2 IDS FTP SERVER	73
2.3 DORIS WEBSITE	74
2.4 DATA CENTERS’ WEBSITES	74
3 THE MAIL SYSTEM	74
3.1 DORISMAIL	74
3.2 DORISREPORT	75
3.3 DORISSTATIONS	75
3.4 IDS ANALYSIS FORUM	76
3.5 OTHER MAILING LISTS	76
4 HELP TO THE USERS	76
APPENDIX 2: DORIS STATIONS COLOCATION WITH TIDE	
GAUGES	77
APPENDIX 3: DORIS STATIONS / HOST AGENCIES	79

IDS AND DORIS QUICK REFERENCE LIST

1. IDS website

<http://ids-doris.org/>

2. Contacts

Central Bureau IDS.central.bureau@ids-doris.org

Governing Board IDS.governing.board@ids-doris.org

3. Data Centers

CDDIS: <ftp://cddis.gsfc.nasa.gov/doris/>

IGN: <ftp://doris.ensg.eu> and <ftp://doris.ign.fr>

4. DORISmail

The DORIS mail service is used to send information of general interest to the DORIS community. To send a DORISmail, use the following address: dorismail@ids-doris.org

5. IDS Analysis forum

The IDS Analysis Forum is a list for discussion of DORIS data analysis topics. To start a discussion on a specific topic, use the following address: ids.analysis.forum@ids-doris.org

6. List of documents and links to discover the DORIS system

<http://ids-doris.org/analysis-documents.html>

7. Citation

The following article is suggested for citation in papers and presentations that rely on DORIS data and results:

Willis P., Fagard H., Ferrage P., Lemoine F.G., Noll C.E., Noomen R., Otten M., Ries J.C., Rothacher M., Soudarin L., Tavernier G., Valette J.J. (2010), The International DORIS Service, Toward maturity, *Advances in Space Research*, 45(12):1408-1420, DOI: [10.1016/j.asr.2009.11.018](https://doi.org/10.1016/j.asr.2009.11.018)

8. List of DORIS publications in international peer-reviewed journals

http://ids-doris.org/report/publications/peer-reviewed_journals.html

9. Overview of the DORIS satellite constellation

<http://www.aviso.oceanobs.com/en/doris/doris-applications/index.html>

10. Site logs

DORIS stations description forms and pictures from the DORIS installation and maintenance department: <http://ids-doris.org/network/sitelogs.html>

11. Virtual tour of the DORIS network with Google Earth

Download the file at <http://ids-doris.org/network/googleearth.html> and visit the DORIS sites all around the world.

12. More contacts

For particular requests, you may also contact the following persons:

Governing Board

Pascal Willis (chairman)

Institut de Physique du Globe de Paris
UFR STEP / GSP Bat Lamarck Case 7011
75205 Paris Cedex 13
France
Phone: +33 (0)1 57 27 84 81
E-mail: willis@ipgp.fr

Central Bureau

Laurent Soudarin (director)

CLS
8-10 rue Hermes
Parc Technologique du Canal
31520 Ramonville Saint-Agne
France
Phone: +33 (0)5 61 39 48 49 / 5 61 39 47 50
E-mail: laurent.soudarin@cls.fr

Pascale Ferrage

CNES
DCT/ME/OT
18, avenue Edouard Belin
31401 Toulouse Cedex 9
France
Phone : +33 (0)5 61 28 30 66
E-mail: pascale.ferrage@cnes.fr

Analysis Coordination

Frank Lemoine

NASA Goddard Space Flight Center
Code 698, Planetary Geodynamics
Greenbelt, Maryland 20771

USA

Phone: +1 (301) 614-6109

E-mail: Frank.G.Lemoine@nasa.gov

CDDIS Data Center

Carey Noll

NASA Goddard Space Flight Center
Code 690
Greenbelt, Maryland 20771

USA

Phone: +1 (301) 614-6542

E-mail: Carey.Noll@nasa.gov

IGN Data Center & Network

Bruno Garayt

Institut Géographique National
73, avenue de Paris,
94165 Saint-Mandé Cedex

France

Phone: +33 (0)1 43 98 81 97

E-mail: bruno.garayt@ign.fr

Network

Jérôme Saunier

Institut Géographique National
73, avenue de Paris,
94165 Saint-Mandé Cedex

France

Phone : +33 (0)1 43 98 83 63

E-mail : jerome.saunier@ign.fr

GLOSSARY

AC

Analysis Center

AGU

American Geophysical Union. AGU is a scientific society that aims to advance the understanding of Earth and space. AGU conducts meetings and conferences, publishes journals, books and a weekly newspaper, and sponsors a variety of educational and public information programs.

AVISO

Archiving, Validation and Interpretation of Satellite Oceanographic data. AVISO distributes satellite altimetry data from TOPEX/Poseidon, Jason-1, ERS-1 and ERS-2, and Envisat, and DORIS precise orbit determination and positioning products.

AWG

Analysis Working Group

CB

Central Bureau

CDDIS

Crustal Dynamics Data Information System

CLS

Collecte Localisation Satellites. Founded in 1986, CLS is a subsidiary of CNES and Ifremer, specializes in satellite-based data collection, location and ocean observations by satellite.

CNES

Centre National d'Etudes Spatiales. The Centre National d'Etudes Spatiales is the French national space agency, founded in 1961.

CNRS

Centre National de la Recherche Scientifique. The Centre National de la Recherche Scientifique is the leading research organization in France covering all the scientific, technological and societal fields

CryoSat-2

Altimetry satellite built by the European Space Agency launched on April, 8 2010. The mission will determine the variations in the thickness of the Earth's continental ice sheets and marine ice cover.

CSR

Center for Space Research, the University of Texas

CSTG

Coordination of Space Technique in Geodesy

DC

Data Center

DGXX

DORIS receiver name (3rd Generation)

DIODE

Détermination Immédiate d'Orbite par DORIS Embarqué. Real-time onboard DORIS system used for orbit determination.

DORIS

Doppler Orbitography and Radiopositioning Integrated by Satellite. Precise orbit determination and location system using Doppler shift measurement techniques. A global network of orbitography beacons has been deployed. DORIS was developed by CNES, the French space agency, and is operated by CLS.

ECMWF

European Centre for Medium-range Weather Forecasting

EGU

European Geosciences Union

EOP

Earth Orientation Parameters

Envisat

ENVironmental SATellite Earth-observing satellite (ESA)

ESA

European Space Agency. The European Space Agency is a space agency founded in 1975. It is responsible of space projects for 17 European countries.

ESA, esa

acronyms for *ESA/ESOC* Analysis Center, Germany

ESOC

European Space Operations Centre (ESA, Germany)

EU

European Union

EUMETSAT

European organisation for the exploitation of METeorological SATellites

GAU, gau

acronyms for the *Geoscience Australia* Analysis Center, Australia

GB**Governing Board****GDR-B, GDR-C, GDR-D**Versions B, C, and D of **Geophysical Data Record****geoc**

Specific format for geodetic product: time series files of coordinates of the terrestrial reference frame origin (geocenter)

eop

Specific format for geodetic product: time series files of Earth orientation parameters (EOP)

GGOS**Global Geodetic Observing System****GMF****Global Mapping Function****GNSS****Global Navigation Satellite System****GLONASS****Global Navigation Satellite System** (Russian system)**GOP, gop**acronyms for the *Geodetic Observatory of Pecný* Analysis Center, Czech Republic**GRGS****Groupe de Recherche de Géodésie Spatiale****GSC, gsc**acronyms for the *NASA/GSFC* Analysis Center, USA**GSFC****Goddard Space Flight Center** (NASA).**HY-2**HY (for **HaiYang** that means 'ocean' in Chinese) is a marine remote sensing satellite series planned by China (HY-2A (2011), HY-2B (2012), HY-2C (2015), HY-2D (2019))**IAG****International Association of Geodesy****IDS****International DORIS Service**

IERS

International Earth rotation and Reference systems Service

IGN

Institut Géographique National, French National Geographical Institute
(**Institut national de l'information géographique et forestière** from January 1st, 2012)

IGN, ign

acronyms for *IGN/IPGP* Analysis Center, France

IGS

International GNSS Service

ILRS

International Laser Ranging Service

INA, ina

acronyms for the *INASAN* Analysis Center, Russia

INASAN

Institute of Astronomy, Russian Academy of Sciences

IPGP

Institut de Physique du Globe de Paris

ISRO

Indian Space Research Organization

ITRF

International Terrestrial Reference Frame

IUGG

International Union of Geodesy and Geophysics

IVS

International VLBI Service for Geodesy and Astrometry

Jason

Altimetric missions (CNES/NASA), follow-on of TOPEX/Poseidon. Jason-1 was launched on December 7, 2001 and Jason-2 was launched on June 20, 2008.

JOG

Journal Of Geodesy

JASR

Journal of Advances in Space Research

LCA, lca

acronyms for the CNES/CLS Analysis Center, France (previously LEGOS/CLS Analysis Center)

LEGOS

Laboratoire d'Etudes en Géodésie et Océanographie Spatiales, France

LRA

Laser Retroreflector Array. One of three positioning systems on TOPEX/Poseidon and Jason. The LRA uses a laser beam to determine the satellite's position by measuring the round-trip time between the satellite and Earth to calculate the range.

MOE

Medium Orbit Ephemeris.

NASA

National Aeronautics and Space Administration. The National Aeronautics and Space Administration is the space agency of the United States, established in 1958.

NCEP

National Center for Environmental Prediction (NOAA).

NLC, ncl

acronyms for *University of Newcastle* Analysis Center, UK

NOAA

National Oceanic and Atmospheric Administration. The National Oceanic and Atmospheric Administration (NOAA) is a scientific agency of the United States Department of Commerce focused on the studies of the oceans and the atmosphere.

OSTST

Ocean Surface Topography Science Team

POD

Precise Orbit Determination

POE

Precise Orbit Ephemeris

Poseidon

One of the two altimeters onboard TOPEX/Poseidon (CNES); Poseidon-2 is the Jason-1 altimeter.

RINEX/DORIS

Receiver INdependent EXchange. Specific format for DORIS raw data files, based on the GPS-dedicated format

RMS

Root Mean Square

SAA

South Atlantic Anomaly

SARAL

Satellite with ARGOS and AltiKa

SINEX

Solution (software/technique) Independent Exchange. Specific format for files of geodetic products

SIRS

Service d'Installation et de Renovation des Balises (IGN). This service is in charge of all the relevant geodetic activities for the maintenance of the DORIS network.

SLR

Satellite Laser Ranging

SMOS

Service de Maintenance Opérationnelle des Stations (CNES). This service is responsible for the operational issues of the DORIS stations

snx see SINEX

SOD

Service d'Orbitographie DORIS, CNES DORIS orbitography service

SPOT

Système Pour l'Observation de la Terre. Series of photographic remote-sensing satellites launched by CNES.

sp1, sp3

Specific format for orbit ephemeris files

SSALTO

Segment Sol multimissions d'ALTimétrie, d'Orbitographie et de localisation précise. The SSALTO multi-mission ground segment encompasses ground support facilities for controlling the DORIS and Poseidon instruments, for processing data from DORIS and the TOPEX/Poseidon, Jason-1, Jason-2 and Envisat-1 altimeters, and for providing user services and expert altimetry support.

STCD

STation Coordinates Difference. Specific format for time series files of station coordinates (geodetic product)

STPSAT

US Air Force **Space Test Program SATellite.** The first satellite **STPSAT1** was launched in 2007 with a new DORIS receiver called CITRIS. This experiment is dedicated to global ionospheric measurements.

SWOT

Surface Water Ocean Topography. Name of a future CNES/NASA satellite mission.

TOPEX/Poseidon

Altimetric satellite (NASA/CNES).

USO

Ultra-Stable Oscillator

UTC

Coordinated Universal Time. Timekeeping system that relies on atomic clocks to provide accurate measurements of the second, while remaining coordinated with the Earth's rotation, which is much more irregular. To stay synchronized, UTC has to be adjusted every so often by adding one second to the day, called a leap second, usually between June 30 and July 1, or between December 31 and January 1. This is achieved by counting 23h59'59", 23h59'60" then 00h00'00". This correction means that the Sun is always at its zenith at noon exactly (accurate to the second).

VLBI

Very Long Baseline Interferometry.

ZTD

Zenith Tropospheric Delay

1 INTRODUCTION

As other space-techniques had already organized into services - the International GNSS Service (IGS) for GPS, GLONASS and, in the future, Galileo (Beutler et al. 1999), the International Laser Ranging Service (ILRS) for both satellite laser ranging and lunar laser ranging (Pearlman et al. 2002) and the International VLBI Service for Geodesy and Astrometry (IVS) for geodetic radio-interferometry (Schlueter et al. 2002) -, the IDS was created in 2003 as an IAG service to federate the research and developments related to the DORIS technique, to organize the expected DORIS contribution to IERS and GGOS (Rummel et al. 2005; Willis et al. 2005), and to foster a larger international cooperation on this topic.

At present, more than 50 groups from 35 different countries participate in the IDS at various levels, including 43 groups hosting DORIS stations in 32 countries all around the globe.

Two analysis centers contributed as individual DORIS solutions to ITRF2005 and in 2006 four analysis centers provided results for IDS. Since 2008, eight analysis groups have provided results, such as orbit solutions, weekly or monthly station coordinates, geocenter variations or Earth polar motion, that are used to generate IDS combined products for geodesy or geodynamics. All these centers have provided SINEX solutions for inclusion in the IDS combined solution that was submitted in 2009 to the IERS for ITRF2008. In 2009, a first IDS combined solution (Valette et al., 2010) was realized using DORIS solutions from 7 Analysis Groups for weekly station positions and daily Earth orientation parameters.

2 HISTORY

The DORIS system was designed and developed by CNES, the French space agency, jointly with IGN, the French mapping and survey agency, and GRGS the space geodesy research group, for precise orbit determination of altimeter missions and consequently also for geodetic ground station positioning (Tavernier et al. 2003).

DORIS joined the GPS, SLR and VLBI techniques as a contributor to the IERS for ITRF94. In order to collect, merge, analyze, archive and distribute observation data sets and products, the IGS was established and recognized as a scientific service of the IAG in 1994, followed by the ILRS in 1998 and the IVS in 1999. It is clear that DORIS has benefited from the experience gained by these earlier services.

There was an increasing demand in the late nineties among the international scientific community, particularly the IAG and the IERS, for a similar service dedicated to the DORIS technique.

On the occasion of the CSTG (Coordination of Space Technique in Geodesy) and IERS Directing Board meetings, held during the IUGG General Assembly in Birmingham in July 1999, it was decided to initiate a DORIS Pilot Experiment (Tavernier et al. 2002) that could lead on the long-term to the establishment of such an IDS. A joint CSTG/IERS Call for Participation in the DORIS Pilot Experiment was issued on 10 September 1999. An international network of 54 tracking stations was then contributing to the system and 11 proposals for new DORIS stations were submitted. Ten proposals were submitted for Analysis Centers (ACs). Two Global Data Centers (NASA/CDDIS in USA and IGN/LAREG in France) already archived DORIS measurements and were ready to archive IDS products. The Central Bureau was established at the CNES Toulouse Center, as a joint initiative between CNES, CLS (Collecte Localisation Satellites) and IGN (Institut Géographique National).

The IDS Central Bureau and the Analysis Coordinator initiated several Analysis Campaigns.

Several meetings were organized as part of the DORIS Pilot Experiment:

DORIS Days were held in Toulouse in May 2000 (see programme and contributions in

<http://ids-doris.org/report/meeting-presentations/doris-days-2000.html>),

an IDS Workshop was held in Biarritz in June 2002 (see programme and contributions in <http://ids-doris.org/report/meeting-presentations/ids-workshop-2002.html>),

an IDS Analysis Workshop was held in Marne La Vallée in February 2003 (see programme and contributions in <http://ids-doris.org/report/meeting-presentations/ids-workshop-2003.html>).

The IDS was officially inaugurated on July 1, 2003 as an IAG Service after the approval of the IAG Executive Committee at the IUGG General Assembly in Sapporo.

The first IDS Governing Board meeting was held on November 18, 2003 in Arles, France.

An IDS plenary meeting was held in Paris in May 2004 (see programme and contributions in <http://ids-doris.org/report/meeting-presentations/ids-plenary-meeting-2004.html>).

An IDS workshop was held in Venice in March 2006 (see <http://ids-doris.org/report/meeting-presentations/ids-workshop-2006.html>).

Two DORIS Analysis Working Group Meetings were held in Paris in March and June 2008 (see <http://ids-doris.org/report/meeting-presentations/ids-awg-03-2008.html> and <http://ids-doris.org/report/meeting-presentations/ids-awg-06-2008.html>).

An IDS workshop was held in Nice in November 2008 (see <http://ids-doris.org/report/meeting-presentations/ids-workshop-2008.html>).

A DORIS analysis Working Group Meeting was held in Paris in March 2009 (see <http://ids-doris.org/report/meeting-presentations/ids-awg-03-2009.html>)

In 2010, a DORIS analysis Working Group Meetings was held in Darmstadt at ESOC in May (see <http://ids-doris.org/report/meeting-presentations/ids-awg-03-2009.html>) and an IDS Workshop was organized on October 21-22, in Lisbon, Portugal (see <http://ids-doris.org/report/meeting-presentations/ids-workshop-2010.html>), where the 20th anniversary of the DORIS system was celebrated.

In 2011, a DORIS Analysis Working Group meeting was held in Paris in May (see <http://ids-doris.org/report/meeting-presentations/ids-awg-05-2011.html>)

In 2012 a DORIS Analysis Working Group will take place in May in Prague (Czech Republic), and an IDS workshop will be held in Venice, Italy in conjunction with the symposium “20 years of progress in Radar altimetry “(see <http://www.altimetry2012.org/>).

3 ORGANIZATION

The IDS organization is very similar to the other IAG Services (IGS: International GNSS Service, ILRS: International Laser Ranging Service, IVS: International VLBI Service for Geodesy and Astrometry) and IUGG Service such as IERS (International Earth rotation and Reference system Service).

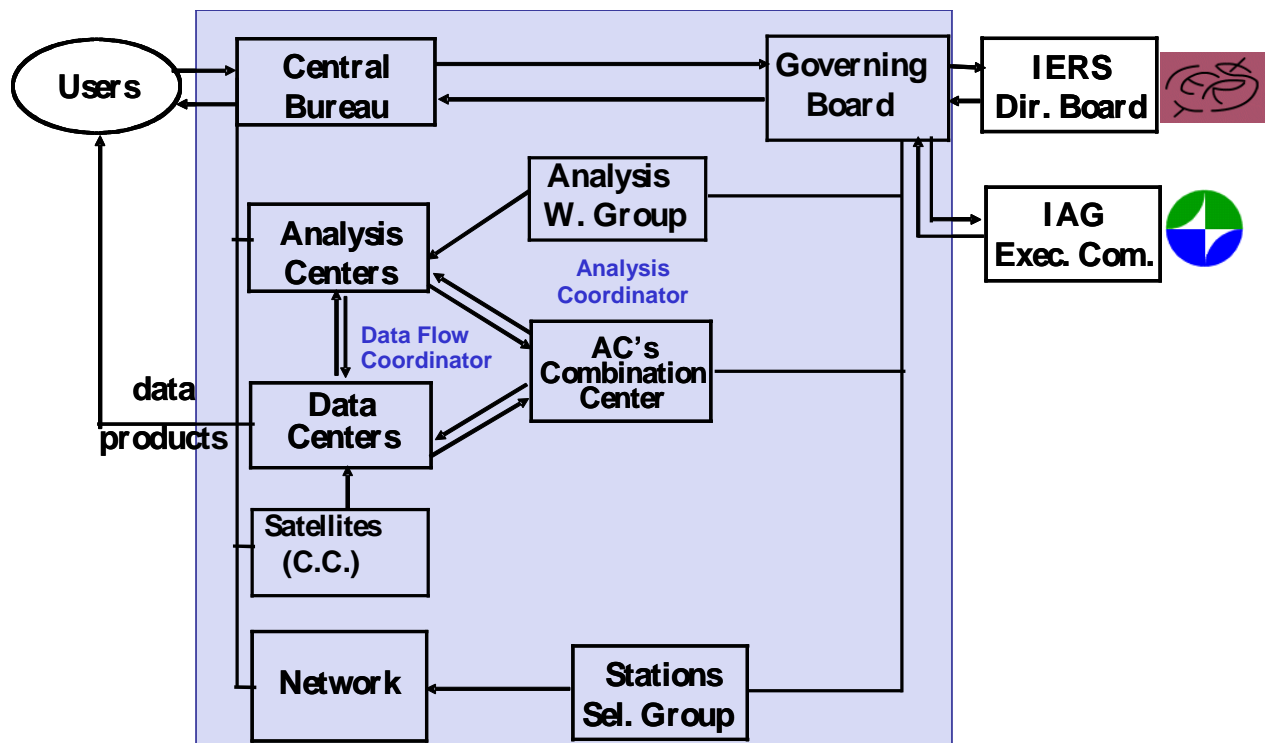

Figure 1 IDS organization

Governing Board

In December 2008, a new Governing board was elected or appointed. In 2011, the Governing Board was:

- Pascal Willis (Chairperson) IGN/IPGP Analysis Center Representative
- Pascal Ferrage CNES Member at Large
- Bruno Garayt IGN Network Representative
- Frank Lemoine NASA GSFC Analysis Coordinator
- Chopo Ma NASA GSFC IERS Representative
- Carey Noll NASA GSFC Data Flow Coordinator
- Michiel Otten ESOC IAG Representative
- John Ries U. Texas CSR Member at Large
- Laurent Soudarin CLS Director of the Central Bureau

Following the change of activities of Hervé Fagard in Fall 2009, Bruno Garayt (IGN) was elected in December 2009 as Network Representative and will serve until 2012 in the IDS Governing Board as all other members. The IDS Governing Board, Central Bureau and members express their warm thanks to Hervé Fagard for his long-term and efficient involvement in the IDS and in the DORIS network installation and maintenance activity.

Central Bureau

In 2011, the IDS Central Bureau is organized as follows :

- Laurent Soudarin CLS (Director)
- Jérôme Saunier IGN
- Pascale Ferrage CNES
- Guilhem Moreaux CLS
- Pascal Willis IGN/IPGP

4 THE CENTRAL BUREAU: IDS INFORMATION SYSTEM

Laurent Soudarin (1), Pascale Ferrage (2)

(1) CLS, France
(2) CNES, France

Like in the previous years, the Central Bureau has brought its supports to the IDS components and continued to operate the information system. We present here the main activities of 2011 and the novelties brought to the IDS web and ftp sites. Plans for 2012 are also given. An overview of the IDS information system is reminded in appendix to this report.

4.1 SUPPORT TO THE IDS COMPONENTS

On GB's request, a Working Group was formed on September 2010 to review and update the IDS Terms of Reference. The WG, chaired by Mike Pearlman, proposed a revised version, which was first adopted by the GB, then by the IAG Executive Committee at the XXVth IUGG General Assembly in July 2011. The main evolutions of the text are:

- Revision of the election process of the GB members; the members at large are elected by the Associates Members, and not by the GB.
- Addition of a representative for the Combination Center.
- Addition of a DORIS system representative appointed by CNES
- Appointment of the network representative by IGN

The new Terms of Reference will be applied for the renewal of the GB whose term is ending in December 2012.

The CB performed the checking of the measurement files (DORIS1b and RINEX) archived at the IDS Data Centers. It led to the correction of file names and the delivery of some missing files.

The CB started the development of web tools to display graphs of time series for station coordinates (STCD) and orbit residuals (POE statistics).

The CB helped Sergey Kuzin to create files and plots of INASAN's coordinate time series. Data (STCD) and GIF are accessible through the Time Series page of the IDS website (<http://ids-doris.org/network/ids-station-series.html>).

The CB organized a survey to hear from its users about the IDS services. It started in January 2012, the result will be available on the IDS website.

4.2 IDS WEBSITE

Address: <http://ids-doris.org>

The main updates of 2011 are reported hereafter:

- A photo gallery (<http://ids-doris.org/gallery.html>) was created. It proposes pictures from some local teams of agencies hosting the DORIS stations (see Appendix 3), as well as photos taken during AWG meetings, IDS workshops, and GB meetings.
- The presentations of the AWG meeting held on May 23-24, 2011, in Paris, France were put on line on a dedicated page (<http://ids-doris.org/report/meeting-presentations/ids-awg-05-2011.html>).
- A new page was created to give information about the next IDS Workshop to be held in Venice on September 2012 (<http://ids-doris.org/report/meeting-presentations/ids-workshop-2012.html>).
- Several activity reports were added (IDS Activity report for 2010, 2007-2011 Report for the International Association of Geodesy, 2008-2009 Report for IERS) as well as the minutes of the IDS GB meetings held in 2011 (<http://ids-doris.org/report/governing-board.html>).
- The list of the peer-reviewed publications related to DORIS has been enriched with 7 new references of articles published in 2011 (<http://ids-doris.org/report/publications/peer-reviewed-journals.html#2011>).
- IGN has updated 7 site logs which can now be seen on the IDS website (Amsterdam Island, Easter Island, Chatham Island, Cibinong, Crozet, Kerguelen, Male, Marion Island, Monument Peak, Mount Stromlo, Rikitea) (<http://ids-doris.org/network/sitelogs.html>).
- New pictures and fish-eye views of the visibility obstruction have been provided by IGN and made available on the site logs pages (Nouméa, Rothera, Dionysos, Djibouti, Marion Island, Toulouse, Fairbanks, Amsterdam Island, Crozet, Rikitea, Cold Bay, Greenbelt, Ascension, Krasnoyarsk) (<http://ids-doris.org/network/sitelogs.html>).

4.3 IDS FTP SERVER

Address: <ftp://ftp.ids-doris.org/pub/ids>

The new documents and files put on the IDS ftp site in 2011 are listed hereafter:

- updates of the history of events impacting the data (pdf [:ftp://ftp.ids-doris.org/pub/ids/data/EventsImpactingDataHistory.pdf](ftp://ftp.ids-doris.org/pub/ids/data/EventsImpactingDataHistory.pdf) ; excel file <ftp://ftp.ids-doris.org/pub/ids/data/EventsImpactingDataHistory.xls>).
- version #2 of the document describing the DORIS satellite models implemented in CNES POE processing; it includes clarifications on Spot-5 solar panel offset. (<ftp://ftp.ids-doris.org/pub/ids/satellites/DORISSatelliteModels.pdf>)

- new version of the DORIS internal tie file provided by IGN; it contains vectors between successive antenna locations on the same site (ftp://ftp.ids-doris.org/pub/ids/stations/DORIS_int_ties.txt)

4.4 FUTURE PLANS

In 2012, the Central Bureau will work on making available the meta-data and DORIS data of the HY-2A satellite. A new version of the site logs with coordinates expressed in ITRF2008 will be put on line. The CB will also implement on the IDS website new plot tools to provide time series browsing in an interactively way. These web tools currently in development will be used to display station position evolution with time, and orbit residuals from CNES/POE processing.

Early January, the DORIS users will be solicited to give their satisfaction level concerning the services provided by the IDS CB. They will be invited to fill in a survey form on the IDS website.

The Central Bureau will participate to the organisation of the IDS Workshop in Venice. A page for the submission of abstract will be proposed on the IDS website in February.

By the end of the year, the CB will organise the elections for the renewal of the Governing Board. The new terms of reference established in 2011 will then be applied.

The Central Bureau will continue to support any new ACs as they join the service.

5 THE NETWORK

Jérôme Saunier (1)

(1) IGN, France

5.1 GENERAL STATUS OF THE NETWORK

We lost a station last year – Monument Peak, CA, USA – because of conflicts in frequency with a nearby TV relay station. Since then, 56 stations make up the DORIS permanent network and two additional stations are dedicated to experimentation: Gavdos (Crete, Greece) and Grasse (France).

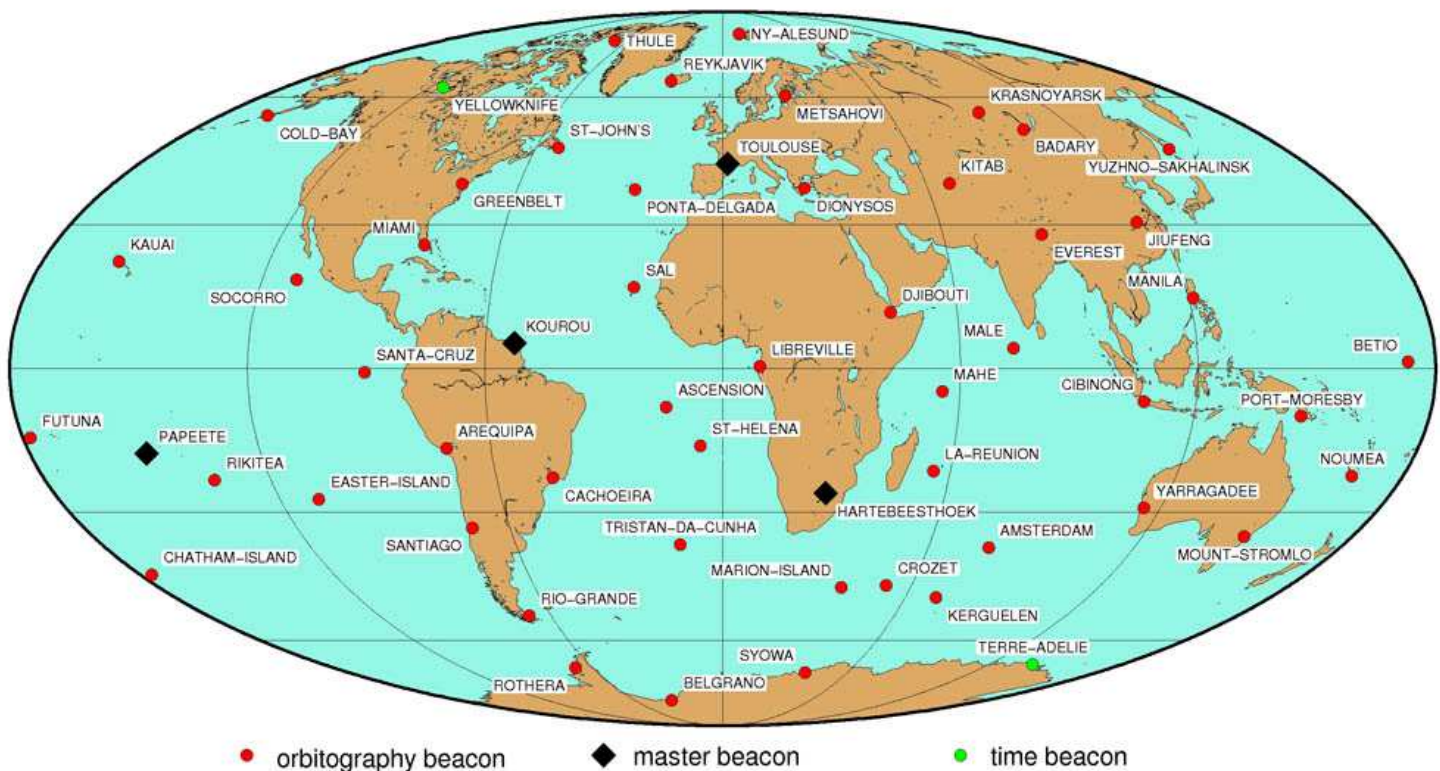

Figure 2 The permanent network - 56 stations

A good geographical distribution of these stations allowed quality of service even if several stations are still out of order. That's the other side of the coin: to get well-distributed network, you need stations out of the way but harder to maintain...

Six stations are out of order for over a year: Yuzhno-Sakhalinsk, Futuna, Santa Cruz, Socorro, Tristan da Cunha, and Port Moresby.

Many beacon failures occurred this year. Installations are ageing. These last three years, half of the total number of beacons was renewed. This result has put momentarily the equipment stock to zero at the end of the year.

5.2 EVOLUTION AND DEVELOPMENT

Two new models of beacon came out this year:

Model 3.1 with mainly software improvement, becoming more simple and strong. Two stations have been equipped this year: Toulouse and Yarragadee.

Model 3.2 is more interesting with regard to the station configuration. This beacon works with optic cables and requires an extend amplifier. This allows till 80m distance between the beacon and the antenna, compared with 15m for regular cables. It will be easier to meet the sky view and stability requirements for DORIS antenna.

Note: this model of beacon (3.2) will not be deployed systematically but according to the layout of the premises.

We are still deploying remote control system allowing distance settings on the beacon: 23 stations are now equipped.

Otherwise, a new project was launched by CNES with the support of IGN: CNES intends to increase its GNSS network in order to set up a global network with short DORIS co-location. The main objective of REGINA (REseau de stations Gnss pour l'Igs et la NAvigation) is scientific: orbito-synchro, Precise Point Positioning applications, Galileo evaluation, etc.

As IGN is involved in the REGINA stations deployment, we took advantage of this opportunity to improve station installations or/and carry out a local tie survey. In any case, this will strengthen contacts with host agencies.

In 2011 the following stations were visited:

- Toulouse : equipment upgrade (3.1)
- Papeete : local tie survey (new REGINA station), reconnaissance 3.2
- Rothera : antenna and support changes, remote control system installing, local tie survey
- Kourou : major renovation (antenna moving), local tie survey (new REGINA station)
- Socorro : reconnaissance for major renovation
- Dionysos : local tie survey (new REGINA station)
- Nouméa : renovation (antenna raising and equipment replacement)

- Futuna : reconnaissance (preliminaries before renovation)
- Rikitea : equipment replacement, remote control, local tie survey (new REGINA station)
- Metsähovi : reconnaissance with a view to co-locate with GNSS + SLR + VLBI
- Mahé : beacon 3.2 and remote control system installing, reconnaissance with a view to move
- HBK : visit (REGINA station upgrade)



Rothera, Antarctic

At the end of the year, we provided a new data set of DORIS stations coordinates and velocities, either from the terrestrial reference frame ITRF2008 (for the main part), or from its derivative for precise orbit determination DPOD2008 (a third), or using the local tie with a GNSS or another DORIS reference point (8 stations). We did also a complete updating of our database and improved its interface with a view to publish soon a new set of site logs.

With regard to the new IDS stations, Riyadh and Tamanrasset are in stand-by for a while. Therefore, we (IDS Governing Board) decided to investigate three new possibilities: Marshall Islands, French West Indies and Korea.

Finally, objectives for the next year are: new stations in Goldstone (in place of Monument Peak) and Chichijima (Japan), and major renovations in Futuna, Tristan da Cunha, Greenbelt, Mahé and Socorro.

6 THE SATELLITES WITH DORIS RECEIVERS

Pascale Ferrage (1)

(1) CNES, France



Initially conceived for the TOPEX/Poseidon mission, the first generation receivers were flown on four satellites:

- SPOT-2, a CNES remote sensing satellite which was launched in 1990 with the first DORIS receiver for a 6-month trial experiment. SPOT-2 was de-orbited in June 2009 (maneuvers were performed in order to lower the orbit so that the spacecraft will re-enter the Earth's atmosphere within 25 years). DORIS has been functioning more than 19 years on-board SPOT-2, far beyond the instrument and spacecraft nominal lifetime.
- TOPEX/Poseidon, a joint venture between CNES and NASA to map ocean surface topography, was launched in 1992. While a 3-year prime mission was planned, with a 5-year store of expendables, TOPEX/Poseidon delivered an astonishing 13+ years of data from orbit: the DORIS mission ended with the second receiver failure in November 2004 whereas the ocean surface topography mapping ended in October 2005,
- SPOT-3 (CNES) was launched in 1993; the spacecraft was lost in November 1996.
- SPOT-4 (CNES) was launched in 1998 and featured the first DORIS real time on-board orbit determination (DIODE).

In the mid-nineties, CNES developed a second-generation dual channel DORIS receiver that was subsequently miniaturized:

- Jason-1, the CNES/NASA TOPEX follow-on mission was launched on December 7, 2001 with a miniaturized second generation DORIS receiver. The receiver was switched on December 8. The orbit accuracy of Jason-1 has been demonstrated to be close to one cm in the radial component (*Luthcke et al. 2003; Haines et al. 2004*). At the present time, Jason-1 DORIS measurements are not used for geodesy, owing to the South Atlantic Anomaly (SAA) effect on the on-board Ultra Stable Oscillator (USO) (*Willis et al. 2004*), however a correction model has been developed (*Lemoine and Capdeville 2006*),
- Envisat, the ESA mission to ensure the continuity of the data measurements of the ESA ERS satellites was launched on March 1, 2002 with a second generation DORIS receiver
- SPOT-5 (CNES) was launched on May 4, 2002 with a miniaturized second generation DORIS receiver.

Then, a new generation DORIS receiver was developed starting in 2005. This receiver called DGXX, includes the following main new features:

1. The simultaneous tracking capability was increased to seven beacons (from only two in the previous generation of receivers)
2. The new generation USO design provides better frequency stability while crossing SAA, and a better quality of MOE useful for beacon location determination.
3. New DIODE navigation software (improved accuracy)

The following satellites have on board a DGXX receiver:

- OSTM/Jason-2 (CNES/NASA/EUMETSAT/NOAA), a TOPEX/Poseidon and Jason-1 follow-on ocean observation mission (same orbit), was launched on June 20, 2008. Jason-2 is based on the same PROTEUS platform as Jason-1, but carries the DGXX DORIS.
- Cryosat-2, the ESA mission dedicated to polar observation, was launched on April 10, 2010 with a DGXX DORIS receiver.
- HY-2A, a Chinese satellite (China Academy of Space) was launched on August 15, 2011 with a DGXX receiver.

Moreover, the satellite STPSAT1 (Plasma Physics and Space Systems Development Divisions, Naval Research Laboratory) with a CITRIS receiver to be used with the DORIS beacon network, was launched on March 9, 2007. This experiment was dedicated to global ionospheric measurements.

Figure 3 gives a summary of the satellites that provide DORIS data to the IDS data centers, as well as the evolution in time of the number of these satellites. Some of the early SPOT-2 data could not be recovered between 1990 and 1992, due to computer and data format limitations. With the exception of this time period, all DORIS-equipped satellites have provided continuous data to the IDS data centers. Please note the large increase in the number of DORIS satellites around mid-2002.

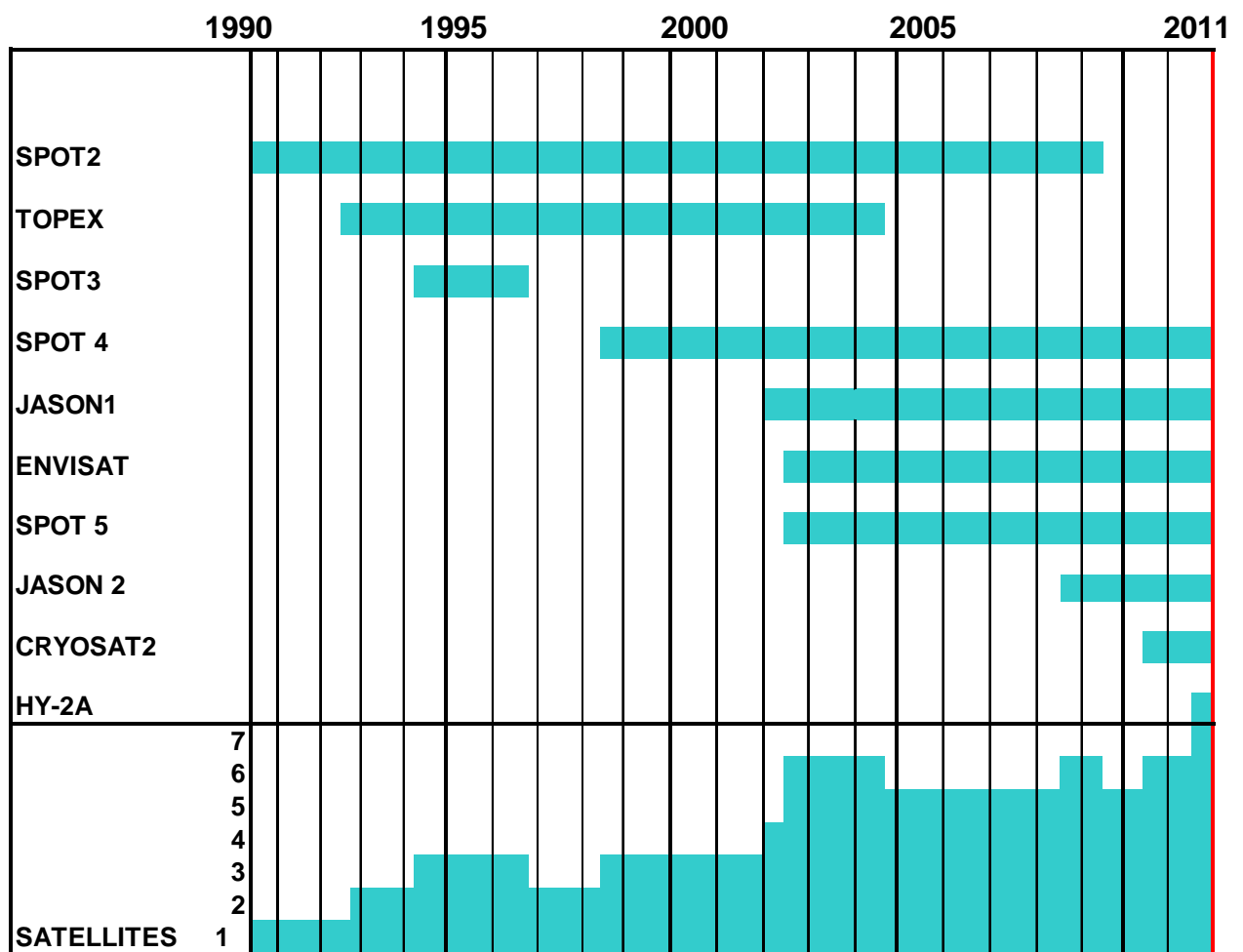
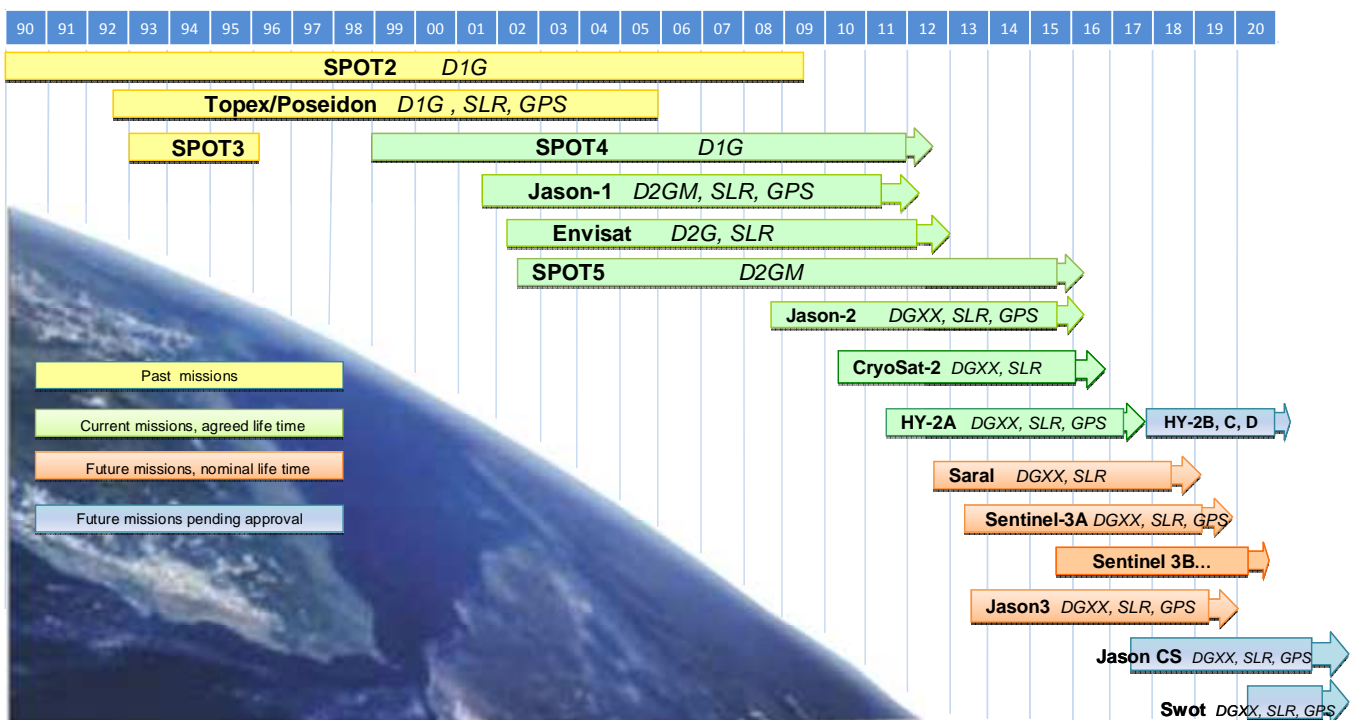

Figure 3 DORIS observations available at the IDS Data Centers (December 2011).

The future DORIS mission are numerous and should guarantee a constellation with at least 4 DORIS contributor satellites through 2025:

- **SARAL/ALTIKA** (ISRO/CNES) is to be launched mid 2012
- **SENTINEL3A** (GMES/ESA) is planned for April 2013, then **SENTINEL 3B** 12 to 30 months later
- **Jason3** (EUMETSAT/NOAA/CNES) is foreseen from mid 2013
- **Jason CS** (Eumetsat/ESA/CNES) is expected for 2017
- **SWOT** is foreseen for 2020

DORIS CONSTELLATION



On board location system

D1G: DORIS 1G

D2G(M): DORIS 2G (*Miniaturized*)

DGXX: DORIS 3rd G

GPS: Global Positioning system

SLR: Satellite Laser Ranging

Figure 4 Current and future DORIS constellation (December 2011).

7 IDS DATA FLOW COORDINATION

Carey Noll (1)

(1) NASA/GSFC, USA

7.1 INTRODUCTION

Two data centers currently support the archiving and access activities for the IDS:

- Crustal Dynamics Data Information System (CDDIS), NASA GSFC, Greenbelt, MD USA
- Institut Géographique National (IGN), Saint Mandé France

These institutions have archived DORIS data since the launch of TOPEX/Poseidon in 1992.

7.2 FLOW OF IDS DATA AND PRODUCTS

The flow of data, products, and information within the IDS is analogous to what is utilized in the other IAG geodetic services (IGS, ILRS, IVS) and is shown in Figure 5. IDS data and products are transmitted from their sources to the IDS data centers. DORIS data are downloaded from the satellite at the DORIS control and processing center, SSALTO (Segment Sol multi-missions d'ALTimétrie, d'Orbitographie et de localisation précise) in Toulouse, France. After validation, SSALTO transmits the data to the IDS data centers. IDS analysis centers, as well as other users, retrieve these data files from the data centers and produce products, which in turn are transmitted to the IDS data centers.

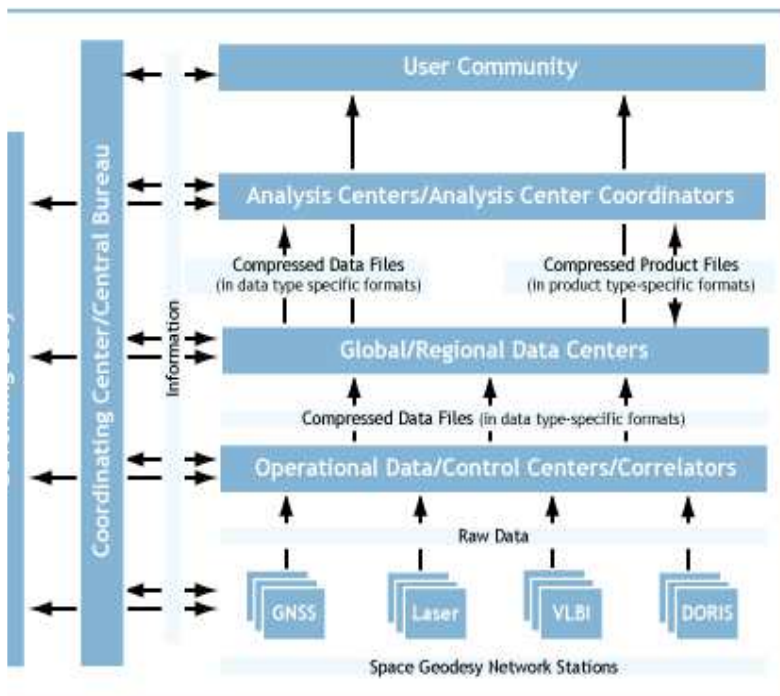

Network Stations

Continuously operational
Timely flow of data

Data Centers

Interface to network stations
Perform QC and data conversion activities
Archive data for access to analysis centers and users

Analysis Centers

Provide products to users
(e.g., station coordinates, precise satellite orbits, Earth orientation parameters, atmos. products, etc.)

Central Bureau/Coordinating Center

Management of service
Facilitate communications
Coordinate activities

Governing Body

General oversight of service
Future direction

Figure 5 Routine flow of data and information for the IAG Geodetic Services

The IDS data centers use a common structure for directories and filenames that was implemented in January 2003. This structure is shown in Table 1 and fully described on the IDS Central Bureau website at http://ids-doris.org/analysis-documents/struct_dc.html. The main directories are:

- */pub/doris/data* (for all data) with subdirectories by satellite code
- */pub/doris/products* (for all products) with subdirectories by product type and analysis center
- */pub/doris/ancillary* (for supplemental information) with subdirectories by information type
- */pub/doris/cb_mirror* (duplicate of CB ftp site) with general information and data and product documentation (maintained by the IDS Central Bureau)

SSALTO and the analysis centers deliver data and products to both IDS data centers (CDDIS and IGN) to ensure redundancy in data delivery in the event one data center is unavailable. The general information available through the IDS Central Bureau ftp site are mirrored by the IDS data centers thus providing users secondary locations for these files as well.

Directory	File Name	Description
Data Directories		
<i>/doris/data/sss</i>	<i>sssdataMMM.LLL.Z</i>	DORIS data for satellite <i>sss</i> , cycle number <i>MMM</i> , and version <i>LLL</i>
	<i>sss.files</i>	File containing multi-day cycle filenames versus time span for satellite <i>sss</i>
<i>/doris/data/sss/sum</i>	<i>sssdataMMM.LLL.sum.Z</i>	Summary of contents of DORIS data file for satellite <i>sss</i> , cycle number <i>MMM</i> , and file version number <i>LLL</i>
<i>/doris/data/sss/yyyy</i>	<i>sssrXYYDDD.LLL.Z</i>	DORIS data (RINEX format) for satellite <i>sss</i> , date <i>YYDDD</i> , version number <i>LLL</i>
<i>ata/sss/yyyy/sum</i>	<i>sssrXYYDDD.LLL.sum.Z</i>	Summary of contents of DORIS data file for satellite <i>sss</i> , cycle number <i>MMM</i> , and file version number <i>LLL</i>
Product Directories		
<i>/doris/products/orbits/</i>	<i>ccc/cccssVV.bXXDDD.eYEEEE.sp1.LLL.Z</i>	Satellite orbits in SP1 or SP3c format from analysis center <i>ccc</i> , satellite <i>sss</i> , solution version <i>VV</i> , start date year <i>XX</i> and day <i>DDD</i> , end date year <i>YY</i> and
	<i>ccc/cccssVV.bXXDDD.eYEEEEday EEE, and file version number LLL.sp3.LLL.Z</i>	
<i>/doris/products/sinex_global/</i>	<i>cccWWuVV.snX.Z</i>	Global SINEX solutions of station coordinates for analysis center <i>ccc</i> , year <i>WW</i> , content <i>u</i> (d=DORIS, c=multi-technique), and solution version <i>VV</i>
<i>/doris/products/sinex_series/</i>	<i>ccc/ccsYYDDDtUuVV.snX.Z</i>	Time series SINEX solutions for analysis center <i>ccc</i> , starting on year <i>YY</i> and day of year <i>DDD</i> , type <i>t</i> (m=monthly, w=weekly, d=daily) solution, content <i>u</i> (d=DORIS, c=multi-technique), and solution version <i>VV</i>
<i>/doris/products/std/</i>	<i>cccWWtu/ccsWWtuVV.stcd.aaaa.Z</i>	Station coordinate time series SINEX solutions for analysis center <i>ccc</i> , for year <i>WW</i> , type <i>t</i> (m=monthly, w=weekly, d=daily), content <i>u</i> (d=DORIS, c=multi-technique), solution version <i>VV</i> , for station <i>aaaa</i>

/doris/products/geoc/	<i>cccWWtuVV.geoc.Z</i>	TRF origin (geocenter) solutions for analysis center <i>ccc</i> , for year <i>WW</i> , type <i>t</i> (m=monthly, w=weekly, d=daily), content <i>u</i> (d=DORIS, c=multi-technique), and solution version <i>VV</i>
/doris/products/eop/	<i>cccWWtuVV.eop.Z</i>	Earth orientation parameter solutions for analysis center <i>ccc</i> , for year <i>WW</i> , type <i>t</i> (m=monthly, w=weekly, d=daily), content <i>u</i> (d=DORIS, c=multi-technique), and solution version <i>VV</i>
/doris/products/iono/	<i>sss/cccsssVV.YYDDD.iono.Z</i>	Ionosphere products for analysis center <i>ccc</i> , satellite <i>sss</i> , solution version <i>VV</i> , and starting on year <i>YY</i> and day of year <i>DDD</i>
/doris/products/2010campaign/	<i>ccc/ccsYYDDDtVV.sss.Z</i>	Time series SINEX solutions for analysis center <i>ccc</i> , starting on year <i>YY</i> and day of year <i>DDD</i> , type <i>t</i> (m=monthly, w=weekly, d=daily) solution, content <i>u</i> (d=DORIS, c=multi-technique), and solution version <i>VV</i> for satellite <i>sss</i>

Information Directories

/doris/ancillary/quaternions	<i>sss/qbodyYYYYMMDDHHMISS- _yyyymmddhhmiss.LLL</i>	Spacecraft body quaternions for satellite <i>sss</i> , start date/time <i>YYYYMMDDHHMISS</i> , end date/time <i>yyyymmddhhmiss</i> , and version number <i>LLL</i>
	<i>sss/qsolpYYYYMMDDHHMISS- yyyymmddhhmiss.LLL</i>	Spacecraft solar panel angular positions for satellite <i>sss</i> , start date/time <i>YYYYMMDDHHMISS</i> , end date/time <i>yyyymmddhhmiss</i> , and version number <i>LLL</i>
/doris/cb_mirror		Mirror of IDS central bureau files

Table 1 Main Directories for IDS Data, Products, and General Information

7.3 DORIS DATA

SSALTO deposits DORIS data to the CDDIS and IGN servers. Software at the data centers scans these incoming data areas for new files and automatically archives the files to public disk areas using the directory structure and filenames specified by the IDS. The IDS data centers currently archive DORIS data from seven operational satellites (SPOT-4, -5, Jason-1, -2, Envisat, CryoSat-2, and HY-2A); data from future missions (e.g., SARAL, etc.) will also be archived within the IDS. Historic data from SPOT-2, SPOT-3, and TOPEX/Poseidon are also available at the data centers. Data from a new satellite, HY-2A, launched in 2011, are now archived in the IDS data centers. A summary of DORIS data holdings at the IDS data centers is shown in Table 2. The DORIS data from all satellites are archived in multi-day (satellite dependent) files using the DORIS data format 2.1 (since January 15, 2002). The DORIS data files are on average two Mbytes in size (using UNIX compression). SSALTO issues an email notification through DORISReport once data are delivered to the IDS data centers. The number of days per file and average latency in 2011 of data availability after the last observation day satellite specific are shown in Table 3. The delay in data delivery to the data centers (in days by satellite) in 2011 is shown in Figure 6; the delay has been reduced significantly over the past two years.

Satellite	Time Span
TOPEX/Poseidon	25-Sep-1992 through 01-Nov-2004
SPOT-2	31-Mar through 04-Jul-1990
	04-Nov-1992 through 14-Jul-2009
SPOT-3	01-Feb-1994 through 09-Nov-1996
SPOT-4	01-May-1998 through present
SPOT-5	11-Jun-2002 through present
Jason-1	15-Jan-2002 through present
Envisat	13-Jun-2002 through present
Jason-2	12-Jul-2008 through present
CryoSat-2	30-May-2010 through present
HY-2A	01-Oct-2011 through present

Table 2 DORIS Data Holdings

Satellite	Number of Days/	Average Latency	Average File
	Multi-Day File	(Days)	Size (Mb)
CryoSat-2	6	24	2.5
Envisat	6	19	2.0
HY-2A	6	*	2.9
Jason-1	10	27	3.3
Jason-2	10	26	5.9
SPOT-4, -5	9	19	1.5-2.5

*Note: Transmission of HY-2A data began in 2012 following satellite validation period

Table 3 Data File Information (V2.1 format)

DORIS phase data from Jason-2, CryoSat-2, and HY-2A are also available in RINEX (Receiver Independent Exchange Format), version 3.0. These satellites house the newer, next generation DORIS instrumentation capable of generating these data in RINEX format; future satellites will also utilize this type of DORIS receiver. These data are forwarded to the IDS data centers in daily files prior to orbit processing within one day (typically) following the end of the observation day. The average file size of the RINEX data is 1.6 Mbytes, 1.8Mbytes, and 2.5 Mbytes for CryoSat-2, HY-2A, and Jason-2 respectively.

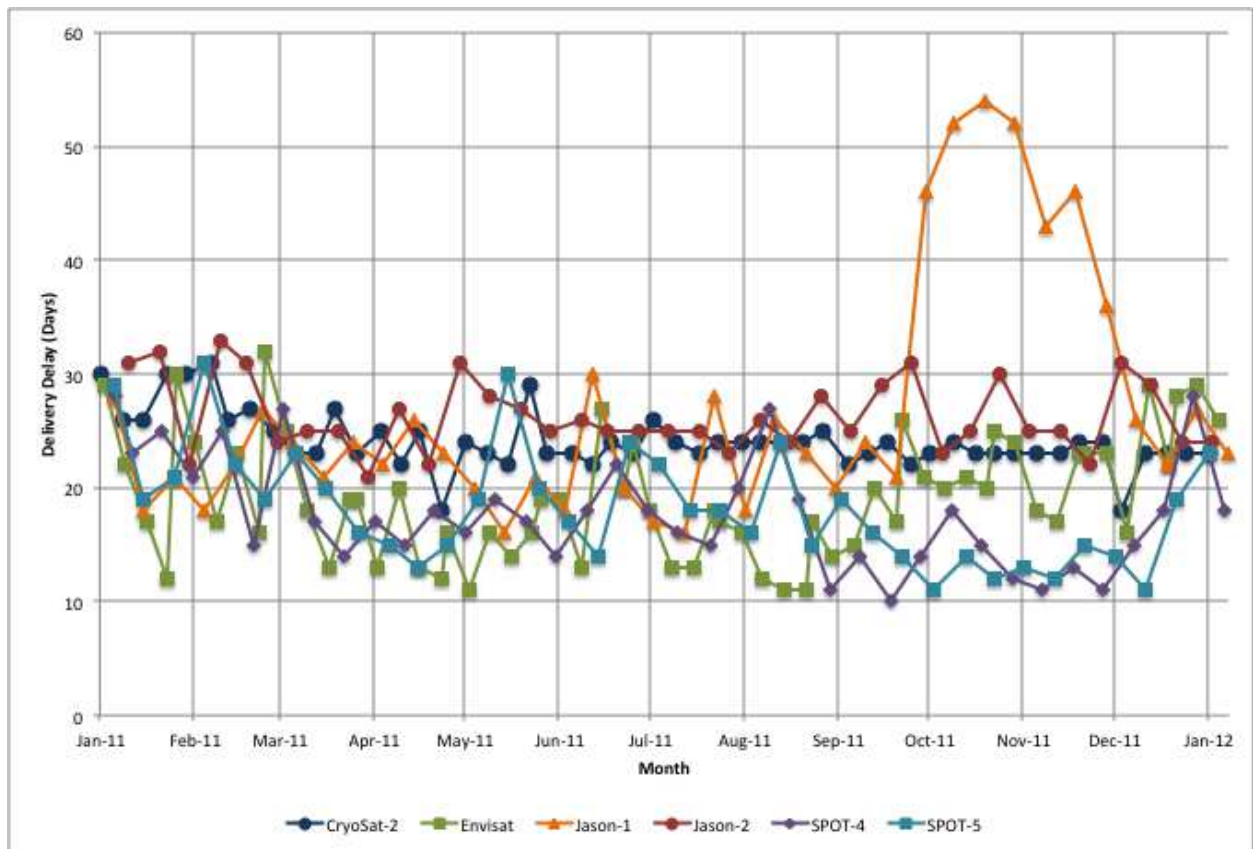

Figure 6 Delay in delivery of DORIS data to the CDDIS (all satellites, 01-12/2011)

7.4 DORIS PRODUCTS

IDS analysis centers utilize similar procedures by putting products to the CDDIS and IGN servers. Automated software detects any incoming product files and archives them to the appropriate product-specific directory. The following analysis centers (ACs) have submitted products on an operational basis to the IDS; their AC code is listed in ():

- European Space Agency (esa), Germany, M. Ottens
- Geoscience Australia (gau), R. Govind

- Geodetic Observatory Pecny (gop), Czech Republic, P. Stepanek
- NASA Goddard Space Flight Center (gsc) USA, F. Lemoine
- Institut Géographique National/JPL (ign) France, P. Willis
- INASAN (ina) Russia, S. Kuzin
- CNES/CLS (lca) France, L. Soudarin
- CNES/SOD (sod) France, L. Cerri
- SSALTO (ssa) France, S. Houry

IDS products are archived by type of solution and analysis center. The types and sources of products available through the IDS data centers in 2005-2011 are shown in Table 4. This table also includes a list of products under evaluation from several DORIS analysis centers.

Type of Product	ACs/Products								
	ESA	GAU	GOP	GSC	IGN	INA	LCA	SSA	SOD
Time series of SINEX solutions (<i>sinex_series</i>)	X	X	X	X	X	X	X	X	X
Global SINEX solutions (<i>sinex_global</i>)					X		X		
Geocenter time series (<i>geoc</i>)					X	X	X		
Orbits/satellite (<i>orbits</i>)				X			X		
Ionosphere products/satellite (<i>iono</i>)							X	X	
Time series of EOP (<i>eop</i>)					X	X			
Time series of station coordinates (<i>stcd</i>)					X	X	X	X	
Time series of SINEX solutions (2010campaign)		X	X	X	X	X	X		

Table 4 Product Types and Contributing Analysis Centers

7.5 SUPPLEMENTARY DORIS INFORMATION

In 2009 an additional directory structure was installed at the IDS data centers containing ancillary information for DORIS data and product usage. Files of Jason-1 and -2 satellite attitude information were made available through the IDS data centers. Two types of files are available for each satellite: attitude quaternions for the body of the spacecraft and solar panel angular positions. The files are delivered daily and contain 28 hours of data, with 2 hours overlapping between consecutive files. Analysts can use these files in processing DORIS data to determine satellite orientation and attitude information.

7.6 FUTURE PLANS

The IDS data centers will investigate procedures to regularly compare holdings of data and products to ensure that the archives are truly identical.

8 IDS DATA CENTERS

Carey Noll (1), B. Garayt (2)

(1) NASA/GSFC, USA

(2) IGN, France

8.1 CRUSTAL DYNAMICS DATA INFORMATION SYSTEM (CDDIS)

The CDDIS is a dedicated data center supporting the international space geodesy community since 1982. The CDDIS serves as one of the primary data centers for the following IAG services:

- International GNSS Service (IGS)
- International Laser Ranging Service (ILRS)
- International VLBI Service for Geodesy and Astrometry (IVS)
- International DORIS Service (IDS)
- International Earth Rotation and Reference Frame Service (IERS)

The CDDIS automated software archives data submitted by SSALTO and performs minimal quality-checks (e.g., file readability, format compliance) resulting in a summary file for each data file. Software extracts metadata from all incoming DORIS data. These metadata include satellite, time span, station, and number of observations per pass. The metadata are loaded into a database and utilized to generate data holding reports on a daily basis. Approximately 55 Gbytes of CDDIS disk space is devoted to the archive of DORIS data, products, and information.

During 2011, user groups downloaded approximately 205 Gbytes (650K files) of DORIS data, products, and information from the CDDIS.

8.1.1 FUTURE PLANS

The CDDIS staff will continue to interface with the IDS CB, SSALTO, and IDS analysis centers to ensure reliable flow of DORIS data, products, and information. Enhancements and modifications to the data center will be made in coordination with the IDS CB. In the spring 2012 the CDDIS will begin operations on an enhanced, distributed server system. Both users and data/product suppliers will continue to access the CDDIS as before. The structure of the DORIS data and product archive will remain unchanged in this new system configuration.

8.1.2 CONTACT

Carey Noll, CDDIS Manager
NASA GSFC
Code 690.1
Greenbelt, MD 20771
USA

Email: Carey.Noll@nasa.gov
Voice: 301-614-6542
Fax: 301-614-6015
ftp: <ftp://cddis.gsfc.nasa.gov/pub/doris>
WWW: <http://cddis.gsfc.nasa.gov>

8.2 IGN DORIS DATA CENTER

To ensure a more reliable data flow and a better availability of the service, two identical configurations have been setup in two different locations at the IGN: (1) Marne-la-Vallée and (2) Saint-Mandé. Each configuration has:

a FTP deposit server for data and analysis centers uploads, requiring special authentication

a free FTP anonymous access to the observations and products

fully independent Internet links.

All the data and products archived and available at IGN GDC may be access through:

- <ftp://doris.ensg.eu> for the Marne-la-Vallée site
- <ftp://doris.ign.fr> for the Saint-Mandé site

During 2011, the IGN data center structure has been enhanced to take into account the coming HY2-A space mission data, including RINEX format, in cooperation with the IDS CB and the CDDIS. Plans for some data flow statistics have been postponed to the next year.

8.2.1 CONTACT

Bruno GARAYT
Institut Géographique National
Service de Géodésie et Nivellement
73, Avenue de Paris
94165 Saint-Mandé Cedex FRANCE

Email: rsi.sgn@ign.fr
Phone: +33 (0)1 43 98 81 97
Fax: +33 (0)1 43 98 84 50

9 IDS ANALYSIS COORDINATION

Frank G. Lemoine (1)

(1) NASA/GSFC, USA

The International DORIS Service held its Analysis Working Group (AWG) meeting at the Bureau des Longitudes, Paris, France, May 23-24, 2011, with 19 participants from all the active analysis centers (ESA, GAU, GSC, GOP, IGN, INA, LCA), as well as the CNES, GRGS, CLS, TU Delft, and UCL (University College London) and the GFZ. The principal themes concerned (1) the status of the IDS Combination; (2) Presentation of the first results concerning analysis of Cryosat-2 data; (3) A detailed report concerning analysis and use of the RINEX phase data for DORIS data analysis; (4) Plans for the operational update to ITRF2008 (DPOD2008); (5) Future plans for improved modeling of the nonconservative forces on the DORIS satellites by UCL; (6) Tests regarding attempts to implement a DORIS phase center correction as a station correction; (7) Analysis of a hypothesis concerning a phase center offset between the Alcatel and Starec antennae. The GFZ (Sergei Rudenko) presented the capabilities of the E/POS software and its capabilities to process LEO satellite data, include DORIS data.

In the year since the last AWG meeting (Darmstadt, 2010), the Cryosat-2 spacecraft has successfully returned data, and a number of analysis centers have analyzed these data and generated SINEX series that include this spacecraft in their solutions. LCA and GSC report fits between 1 – 1.5 cm for SLR data analyzed in combination with DORIS data. CNES reports that the RMS of SLR residuals ($> 70^\circ$ elevation) of 2.0 cm for Cryosat-2 DORIS-only orbits.

Concerning Cryosat-2, analysis centers need to be aware of the duration of the spacecraft maneuvers, and the choice of macromodels that they have available. Two macromodels are available – an ESA-supplied 6-plate macromodel (which is in the shape of a rectangular prism) and a CNES-supplied 7-plate macromodel (in the shape of a standard trapezoidal prism). The CNES macromodel more closely approximates the shape of the Cryosat-2 spacecraft, which has no articulating appendages. The performance in terms of empirical accelerations, and tuning of the macromodel parameters will be slightly different for the two models.

Guilhem Moreaux (CLS) presented the Combination Center report regarding the analysis of the recent SINEX series delivered by the different analysis centers. While Jason-2 has previously been shown to make a substantial contribution to the DORIS weekly solutions due to the quantity of the data provided and the stabilizing influence on the TZ component of geocenter, Cryosat-2 has only a small albeit beneficial influence. This can be ascribed to the lower altitude (720 km compared to 1336 km for Jason2) and the fact that the polar-orbiting satellite has a similar observation geometry to the other sun-synchronous DORIS satellites.

An outstanding question that emerged in the combination was why analysis centers fall in to two groups regarding the scale of their solutions. Whereas GOP, IGN, INA, LCA have a scale > 0 (with respect to ITRF2008), ESA, GAU, and GSC had a scale < 0 (also w.r.t. ITRF2008). The difference cannot really be ascribed to the troposphere mapping function since both ESA and GOP use GMF/GPT; Nor a priori can the difference be ascribed to application of station vertical eccentricity and spacecraft DORIS offset vector inside the analysis software rather than using the DORIS-data-supplied correction (both LCA and ESA calculate these corrections themselves, whereas the other ACs used the DORIS-data supplied correction). The consequence is that the DORIS scale of the combination will be an average of the scale of the different AC's. The exact source of this difference remains elusive but needs to be clarified before any recomputation for a new ITRF.

The refraction correction for troposphere is obviously an important concern in the analysis of DORIS data. In this past year, there have been several developments among the analysis centers concerning refinements in troposphere modeling that will benefit DORIS analyses for a new ITRF. IGN showed that the estimation of one gradient per day (in the east and the north direction) resulted in an improvement of 1-2 mm in the weekly station repeatability. ESA reports similar results after testing data for 2010 onwards, when up to five satellites are available. ESA also reports the testing of the inclusion of lower elevation data (below 10° elevation) with a downweighting function. GSC reports that they have implemented the GMF mapping function in GEODYN. Although it is not part of their operational series (gscwd11, gscwd12) for the sake of continuity, it will be available for use when a new SINEX series is computed.

Several analysis centers have upgraded or are working to update their analysis software. LCA reported the development of a new version of GINS that includes improved attitude models for TOPEX, Envisat, Jason-1, and Jason-2, and correction of an error in the adjustment of the frequency bias on DORIS data. GOP in cooperation with T.U. München (Urs Hugentobler and Carlos Rodriguez) is developing a new version of the Bernese software. The estimation of stochastic parameters is replaced with a direct dynamical modeling for the nonconservative forces (MSIS86, JB2008 for atmospheric drag; a box-wing model for solar radiation pressure, and an a priori model for planetary radiation pressure).

It has previously been shown that solar radiation pressure mismodeling can induce errors in the geocenter estimation at the draconitic period for a given satellite, and induce unwanted signals in time series of station coordinates. The University College London (UCL) at the DORIS AWG announced the initiation of work to develop refined models for the DORIS satellites (SPOT4, SPOT5, Cryosat2, and Jason-2). This model would take the form of the successful high-fidelity models previously developed for the Jason-1, Envisat, and GPS spacecraft. This would be an important advance, since for these satellites in the traditional approach with satellite macromodels, self-shadowing and thermal re-radiation is not typically accounted for.

In support of the analysis activities two papers were presented during 2011: an oral paper at the European Geosciences Union meeting in Vienna, Austria, and a poster at the Fall Meeting of the American Geophysical Union in San Francisco.

Moreaux G., Lemoine F., Soudarin S., Willis P., Stepanek P., Otten M., Govind R., and S. Kuzin, Research activities for continued improvement in the DORIS contribution to the reference frame, Geophysical Research Abstracts, Vol. 13, EGU General Assembly 2011, Vienna, Austria, Paper EGU2011-5988.

Moreaux G., Lemoine FG, Capdeville H, Willis P, Stepanek P, Otten M, Govind R, and S. Kuzin, Impact of Jason-2 and Cryosat-2 on DORIS combination, American Geophysical Union Fall Meeting, San Francisco, Abstract G53A-0894.

GGOS Unified Analysis Workshop

On behalf of the IDS, L. Soudarin and G. Moreaux attend the third GGOS Unified Analysis Workshop in Zurich, Switzerland, Sept. 16-17, 2011:

(http://www.iers.org/nm_10448/IERS/EN/Organization/Workshops/Workshop2011.html)

The purpose of the workshop was to provide a forum to integrate and coordinate the analysis strategies of the geodetic services, and to focus on problems in analysis or modeling that are common to all the services. L. Soudarin presented a paper on behalf of the IDS, “IDS Products and Service Status.” A series of action items were generated as a result of the meeting. Only one action items as of this writing directly concerns the IDS in the coming year. The IERS requests that analysis centers associated with each geodetic technique process five years of data (2006-2011) and apply an IERS-supplied atmospheric loading time series. The purpose is to assess the utility and feasibility of the techniques applying atmospheric loading at the observation level for the computation of the next ITRF. Two SINEX series will need to be supplied, which differ only in the application of this IERS-supplied correction.

10 IDS COMBINATION

Guilhem Moreaux (1)

(1) CLS, France

10.1 ACTIVITY SUMMARY

IDS combination activities in 2011 were devoted to i) the pursuit of the IDS combination and the improvement of the operational chain, ii) the pursuit of IDS 2010 campaign, iii) the analyses of series including Cryosat-2 and iv) communications at EGU and AGU meetings.

10.2 IDS ROUTINE COMBINATION

The last 12 months were dedicated to the pursuit of the multi ACs weekly SINEXs combination. The combination procedure has been upgraded and consists now in 3 steps: 1) evaluation of ACs SINEXs w.r.t ITRF2008 2) combination of all ACs series and 3) evaluation of ACs SINEXs w.r.t the IDS combined series. Moreover, the evaluation process includes a comparison of the ACs DORIS stations network w.r.t the operational network as output of the SMOS database (see for example Figure 7). This new evaluation step allows, for example, to identify operational stations, which are never processed by the ACs as well as to recommend ACs to upgrade stations acronyms.

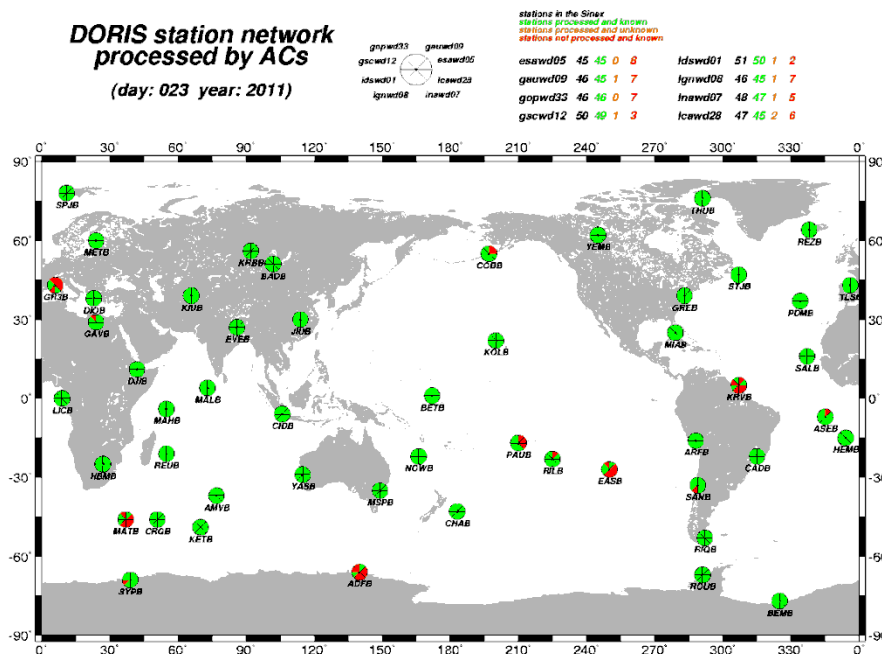

Figure 7. Example of comparisons of the ACs DORIS stations network w.r.t the operational network from SMOS database.

In the frame of the oral presentation for EGU 2011, the IDS combined series has been extended since last delivery for ITRF2008. At the end of 2011, this multi-ACs series stops at the end of the first quarter of 2011.

10.3 IDS 2010 CAMPAIGN

In 2011, the IDS 2010 campaign activities have been devoted to the analyses of the so-called Jason-2 Jason-1 like series (i.e. Jason-2 2DFCs) provided by LCA. That series, which has been designed to better understand the impact of the 7 DORIS frequency channels (DFCs) of the new DORIS DGXX receiver, used the Jason-1, 2 tandem period (September to December 2008) to

- 1) Extract list of stations simultaneously tracked onboard Jason-1 2 DFCs and Jason-2 7 DFCs.
- 2) Compute Jason-2 orbit from observations subset determined in 1)
- 3) Estimate so-called Jason-2 Jason-1 like solution using 1)

As depicted in Figure 8, the increase of DFCs on the DGXX receiver has a positive impact on the Tz parameter.

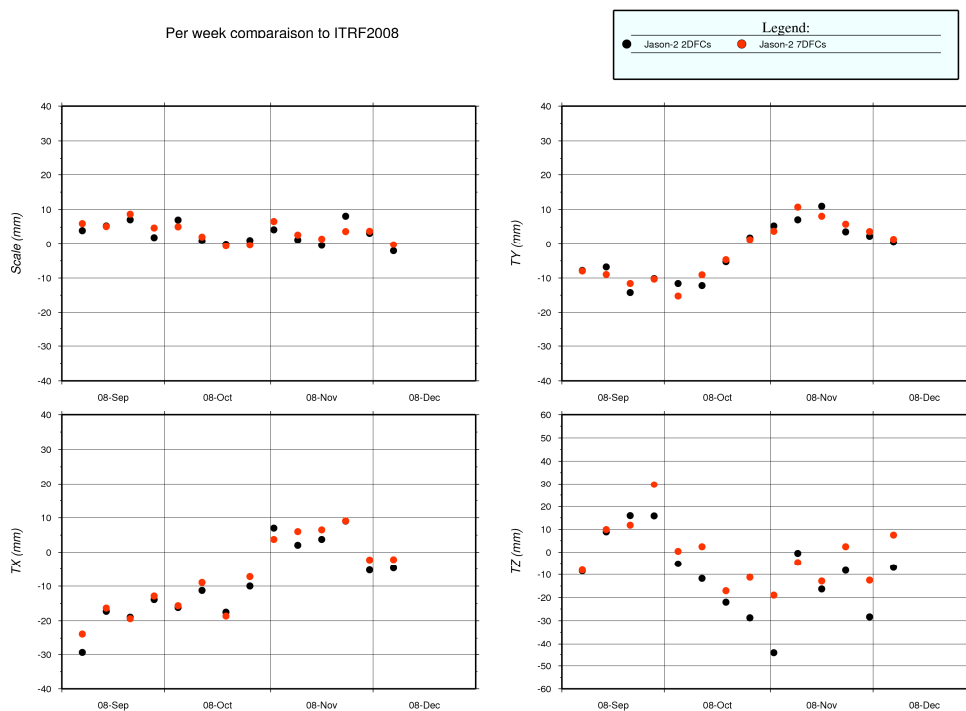

Figure 8. Evaluation results of the Jason-2 Jason-1 like series.

At this stage of the IDS 2010 campaign study, the following questions remain opened:

- Origin of Tz offsets of Envisat and Spot4.
- Origin of two groups of ACs solutions w.r.t scale sign.

10.4 FIRST CRYOSAT-2 ANALYSES

At the end of 2011, 6 ACs (esa, gau, gop, gsc, ign and lca) deliver multi-satellite solutions including Cryosat-2. Cryosat-2, which was launched on April 2010, is the second DORIS satellite with the new DGXX DORIS receiver onboard (the first one was Jason-2). The analyses of these new series shown that adding Cryosat-2 has no major impact on the series in terms of transformation parameters (see for example Figure 9).

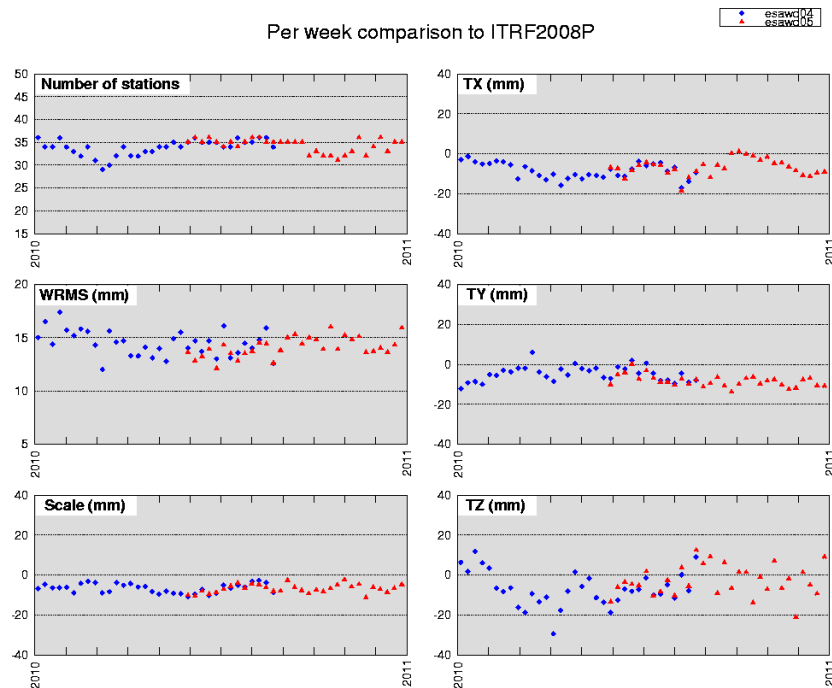

Figure 9. Impact of Cryosat-2 on ESA solutions.

Two reasons can explain that Cryosat-2 has no such impact as Jason-2:

1. Cryosat-2 altitude (717 km) is lower than Jason-2 (1,336 km) so the 7 channels of the DORIS receiver are less used.
2. Cryosat-2 orbit inclination (92°) is closer than Jason-2 (66°) to the other 3 DORIS satellites (98°) used in the combined solutions.

Due to its polar orbit, the major impact of Cryosat-2 should be on the DORIS stations positions located at high latitude. This topic is planned to be studied in 2012 by the IDS CC.

10.5 COMMUNICATIONS

The IDS Combination Center joined both EGU and AGU fall meetings where it presented, respectively, an oral presentation titled “Research activities for continued improvement in the DORIS contribution to the reference frame” (Session G2.4), and the poster “Impact of Jason-2 and Cryosat-2 on DORIS combination” (Session G53A).

10.6 FUTURE PLANS

The activity of the IDS Combination Center in 2012 will concern the improvement of the operational combination service (operational delivery of combination reports, production of STCDs for at least the IDS combined series), the pursuit of realization of routine combinations and first analyses on combined series including HY-2A data, analyses of the Cryosat-2 impact on stations positions at high latitude.

11 REPORT OF THE ESA/ESOC ANALYSIS CENTER (ESA)

Michiel Otten (1), Claudia Flohrer (1), Werner Enderle (1)

(1) European Space Operation Centre, Darmstadt, Germany

11.1 INTRODUCTION

Whereas in 2010 the focus of the European Space Operation Centre activities have been on automation and the routine delivery of the ESA IDS solutions to CDDIS the main activity for 2011 was the preparation and generation of the new esawd06 solution.

11.2 ROUTINE PROCESSING AND THE NEW ESAWD06 SOLUTION

Since August 2010 the ESA IDS weekly solutions has been routinely generated as soon as all the DORIS data became available. This processing has been fully automated meaning a considerable reduction in manual work needed at ESOC for the IDS processing. This automatic processing has proven to very reliable and has been running throughout 2011 without any major issues.

This has meant that ESOC could focus its IDS activities on improving the current esawd05 solution. After generating several test solutions the esawd06 solution will include the following major changes compared to esawd05:

- Tropospheric gradients in North and East (daily)
- Usage of low elevation data (up to 5 degrees) mainly impacts the newer satellites with the DGXX receiver
- Switch to GFZ-GRGS EIGEN-6C model for gravity
- Including of Atmospheric Tides (Ray-Ponte 2003)
- IERS 2010 conventions instead of IERS 2003
- Inclusion of HY-2A

This updated solution will cover the entire IDS processing period from 1993 onwards. Final delivery to CDDIS is expected to happen in June 2012.

We are continuing to participate in the combination on the observation level campaign (COL) and as part of these activities have generate an ESA solution in which we have combined all space born geodetic data (SLR, DORIS and GNSS) on the observation level.

11.3 FUTURE ACTIVITIES

The Navigation Support Office plans for 2012 to switch to processing the DORIS RINEX data for Jason-2, Cryosat-2 and HY-2A instead of the older DORIS Data Exchange Format. Further we are preparing for the ITRF2013 call and the esawd06 solution will form the basis for the new ESOC solution to ITRF2013.

For the COL activities we plan to extend the ESA solution beyond the CONT08 and CONT11 periods and will evaluate to possibility to complement our technique specific solutions with this combined solution.

12 REPORT OF THE GEOSCIENCE AUSTRALIA ANALYSIS CENTER (GAU)

Ramesh GOVIND (1)

(1) Geoscience Australia, Canberra, Australia.

The main DORIS analysis activity during 2011 was to contribute weekly multi-satellite SINEX solution to the IDS Combination Centre; solutions for all of 2011 were submitted. The solutions up to the end of 7-day arc beginning 15th May 2011 (gau11135wd09) comprised DORIS data from SPOT-4, SPOT-5, Envisat and Jason-2. Further, these solutions were based on apriori coordinates and Earth Orientation Parameters (EOP) ITRF2005 and IERS C04-05, respectively. Since the arc beginning 22nd May 2011 (gau11142wd10), Cryosat-2 DORIS data has been included and the apriori coordinates and EOP were based on ITRF2008 (supplemented by DPOD2008 with discontinuities) and IERS C04-08, respectively. This contribution was reported in AGU poster (Moreaux et al, 2011).

The DORIS determined orbits for Envisat, Jason-2 and Cryosat-2 are continually assessed with respect to the observed SLR data for the respective satellites.

The IDS analysis activity at Geoscience Australia is undertaken in collaboration with the GSFC Analysis centre – making orbit comparisons. In addition, results of non-conservative force modelling (General Acceleration – one-per-rev along and cross-track amplitude) for all satellites during 2010 were submitted to GSFC and compared for consistency.

13 REPORT OF THE GEODETICAL OBSERVATORY PECNY ANALYSIS CENTER (GOP)

Petr Stepanek (1)

(1) Geodesy Observatory Pecný, Research Institute of Geodesy, Czech Republic

13.1 ROUTINE DATA PROCESSING

All the DORIS data from October 2010 to September 2011 were processed and analyzed. The two kinds of solutions were generated, using identification wd32 and wd33. The difference between both solutions consists in the satellite constellation. The solution 32 includes the data from the satellites SPOT-4, SPOT-5, Envisat and Jason-2, while solution 33 includes the Cryosat-2 data in addition. As the major improvement of the processing standards, the FES 2004 OT model was implemented to substitute the older model CSR 3.0.

The inclusion of Cryosat-2 didn't bring a major effect on the accuracy of the solution or a markedly higher stability of the transformation parameters with respect to the ITRF. The impact of addition of the new satellite into the solution is probably not so high as in the case of Jason-2. There was only a minor effect on Tx, Ty parameters. The Tz translation parameter derived from a Cryosat-2 single-satellite solution express a strong annual signal. On the other hand there is a significant impact of Cryosat-2 on the Earth rotation pole coordinates estimation. The solution 33 expresses a lower RMS with respect to IERS C04 model. In comparison to solution 32, RMS of Xp decreased from 0.50 mas to 0.38 mas and RMS of Yp decreased from 0.42 mas to 0.38 mas.

The weekly multi-satellite solutions were delivered to the IDS data center(s) in SINEX format and the corresponding files are available for free download.

13.2 DEVELOPMENT OF THE DYNAMICAL ORBITAL MODEL

Current routine GOP DORIS data processing is based on the empirical and pseudo-stochastic orbital modeling. This approach is supplying exact non-conservative force models, missing in the Bernese GPS Software. The important goal to improve the orbit modeling is the implementation of the Satellite attitude and macro-models and non-conservative perturbation force models. The development started in late 2010, as the joint project of GOP and the Institute for Astronomical and Physical Geodesy at the Technische Universität München. Currently, the necessary non-conservative perturbation force models are implemented, as well as the satellite attitude models for all the present and past DORIS satellites according to the CNES standards. The implemented force models include the solar radiation pressure, atmosphere drag (MSIS-86 density model) and the Earth radiation pressure (direct and indirect).

The first set of the tests of the model was based on the external comparison of the estimated DORIS orbit to the multi-technique CNES/SSALTO orbit. Preliminary presented results (AGU Fall meeting, December 2011) were affected by signal with period about 14-15 days. As the impact of last days, the error in ocean tidal modeling being as the source of the signal was detected and corrected. The last results, based on the comparison of 40 processed days of data, show very good agreement of the estimated orbit with CNES/SSALTO orbits. Radial (absolute) Mean achieved value under 0.4 cm for all the satellites and the radial RMS was under 1.5 cm (For Cryosat and Envisat radial Mean was under 0.1 cm and RMS under 1.0 cm).

The main goal of future work is a complex testing of both approaches, dynamical and reduced-dynamical orbit modeling, using external and internal comparison. Very important is also analyzing the impact of the orbital modeling on the free-network solutions and the derived quantities.

14 REPORT OF THE GSFC/NASA ANALYSIS CENTER (GSC)

**Frank G. Lemoine (1), Nikita P. Zelensky (2), Karine Le Bail (1,3), Douglas S. Chinn (2),
J. W. Beall (4,1)**

(1) GSFC/NASA, USA

(2) SGT/NASA, USA

(3) NVI Inc., Greenbelt, Maryland, U.S.A

(4) Mission Operations and Services, Riverdale, Maryland, U.S.A

14.1 SINEX SERIES

We have routinely processed the data to five DORIS satellites: SPOT4, SPOT5, Envisat, Jason-2 and Cryosat-2. As of the end of 2011, the processing has been completed through the week of October 2, 2011. Two SINEX series in normal equation format, including station positions and Earth orientation parameters, have been submitted to the NASA CDDIS data center: the GSC wd11 series (including SPOT4, SPOT5, Envisat, Jason-2), and the GSC wd12 series (including Cryosat-2 in addition to the other satellites). We do not add process Jason-1 to the SINEX solutions even though an SAA correction model is available so as to not contaminate the position+EOP solutions with potential errors due to the instability of the Jason-1 DORIS USO as it crosses the SAA.

The processing for these satellites has been documented in the following DORISREPORTS:

DORISREPORT 2682 (13-Oct-2011). 110102 to 110327 (gscwd11, gscwd12)

DORISREPORT 2701 (27-Oct-2011). 110703 to 110703 (gscwd11, gscwd12)

DORISREPORT 2525 (03-Jun-2011). 100606 to 110327 (gscwd12)

DORISREPORT 2774 (22-Dec-2011). 110701 to 111002 (gscwd11, gscwd12).

The models for this processing are documented in Le Bail et al. (2010) and Zelensky et al. (2010), where we have made one change: The Jason-2 Cr is applied as a value of 0.945. We find that this reduces the magnitude of the estimated daily empirical accelerations. The modeling for Cryosat-2 is discussed below. All arcs are nominally seven days in length, except for times there are maneuvers.

We routinely validate the solutions by comparing the time history of the RMS of fit, search for solutions with anomalous values of the daily amplitude of the along-track and cross track empirical accelerations. In addition for Jason-2, Cryosat-2 and Envisat we routinely inter-compare the DORIS-only and the SLR+DORIS orbits.

Table 5 summarizes the POD Performance for the various satellites in 2011 for processing that involves only the DORIS data. Table 6 summarizes the POD performance for the SLR+DORIS satellites, and the orbit differences between the SLR+DORIS and DORIS-only orbits. Figure 10 summarizes the DORIS-system time biases computed for the DORIS+SLR orbits. All DORIS-system time biases for Envisat, Jason-2 and Cryosat-2 are below 1 μ sec.

Satellite	Avg. DORIS RMS	Daily OPR Amp.	
		(median, for 2011, nm/s ²)	
	(mm/s)	Along	Cross
SPOT4	0.472	1.24	4.00
SPOT5	0.436	5.61	1.18
Envisat	0.492	10.9	1.87
Cryosat-2	0.458	2.21	2.83
Jason-2	0.375	0.94	4.54

Table 5: 2011 DORIS Satellite POD Performance (DORIS-only)

Satellite	Avg SLR RMS	Avg. DORIS RMS	Daily OPR Amp.		RMS orbit differences (SLR+DORIS vs. DORIS-only, cm)		
			(median, for 2011, nm/s ²)		Rad	CrS	Alg
	(cm)	(mm/s)	Along	Cross			
Envisat	1.74	0.498	10.6	2.65	0.46	2.32	1.95
Cryosat-2	2.14	0.434	2.26	2.81	0.62	2.43	2.73
Jason-2	1.36	0.352	0.94	5.89	0.61	2.40	2.51

Table 6: 2011 DORIS Satellite POD Performance (SLR+DORIS)

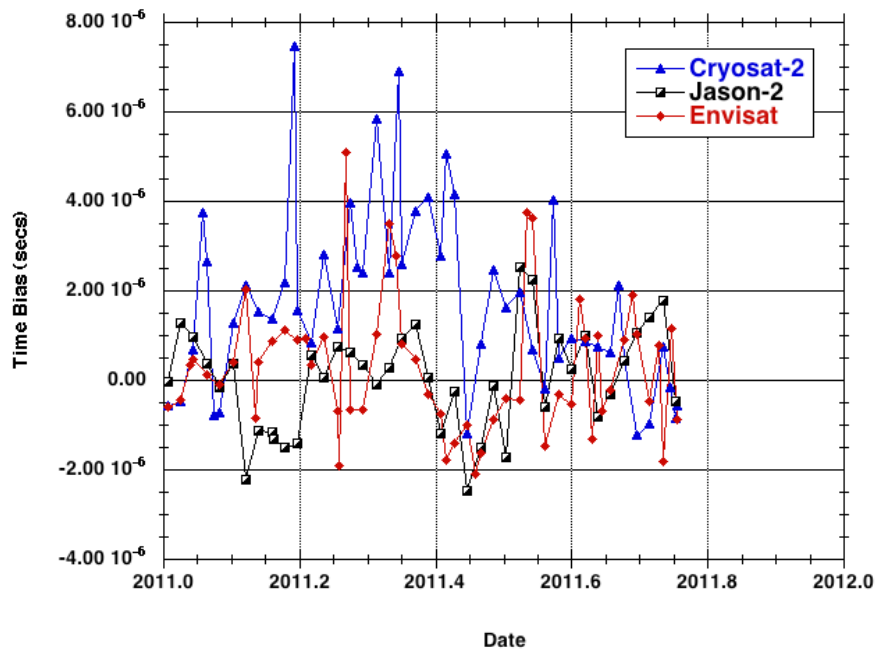

Figure 10 DORIS System time biases from 2011 GSC DORIS+SLR Arcs (Cryosat-2, Jason-2 and Envisat).

14.2 TOPEX, JASON-1, JASON-2 SLR/DORIS POD PROCESSING

In 2011 the GSC analysis center developed several new time series of orbits for the altimeter satellites, TOPEX, Jason-1, and Jason-2 based on processing of the SLR and DORIS data. All these orbits were based on ITRF2008 (Lemoine et al., 2011; Zelensky et al., 2011). The various time series are designated as follows:

1. **std1007**: ITRF2008-based orbits. Update of the orbits described in Lemoine et al. (2010), Zelensky et al. (2010), which were based on ITRF2005.
2. **std1007 cr**: Retune of the reflectivity coefficient (C_r) of Jason-2. We found that retuning the C_r with a value of 0.945 reduced the amplitude of the daily along-track empirical accelerations that are routinely estimated as part of each Jason-2 orbit solution.
3. **std1110 (experimental)**: A set of orbits using a time series of weekly 4x4 gravity coefficients determined from SLR and DORIS tracking of up to nine satellites from 1993 to 2011. These gravity coefficients were used in lieu of the corresponding static coefficients from the GGM03S gravity model. In addition SLRF2008 and a preliminary version of DPOD2008 (version 1.3) are applied, and the GMF mapping function is applied to the DORIS data in lieu of the Niell mapping function.

4. **red-std1110 (experimental):** The same orbits as in (3) but computed with a reduced-dynamic parameterization.

In Table 7, the POD statistics are presented for the orbits from (2), (3), and (4) above and compared with orbits provided by the CNES for GDR-C, and a test series for the new GDR-D, with orbits provided by ESOC, and the GPS-only reduced-dynamic orbits provided by JPL. The results indicate that the application of more detailed models of time-variable gravity with the std1110 orbits or in the GDR-D – which uses a later and more detailed GRACE-derived static and time-variable gravity model – provide superior orbit performance. However, the challenge is deriving a uniform orbit standard over the entire time period (1993-2011) when GRACE data are not available over the entire time period, and thus the time-variable gravity solutions will by their nature be heterogeneous.

Orbit			
	DORIS (mm/s)	SLR (cm)	Xover (cm)
std1007_cr	0.3704	1.148	5.449
std1110	0.3705	1.143	5.421
red_std1110	0.3696	1.060	5.378
GDR-C(cnes)	0.3705	1.160	5.483
GDR-D-test (cnes)	0.3703	1.139	5.441
ESA (ESOC)	0.3702	1.480	5.386
JPL11a	0.3700	1.139	5.323

Table 7: Jason-2 Orbit comparison summary cycles 1-105

The std1007 (ITRF2008-based) orbits have been released to the NASA Physical Oceanography Distributed Active Archive Center (PODAAC) for use on the MEASURE's Integrated Multimission Ocean Altimeter Data for Climate Research V1.0 sea surface height (SSH) anomaly dataset. The altimeter data from the multi-mission Geophysical Data Records (GDRs) are interpolated to a common reference orbit and grid, facilitating direct time series analysis of the geo-referenced height, including calculations of regional and global sea level change. This dataset is available at the following URL: http://podaac.jpl.nasa.gov/highlights/MEaSUREs_TPJAOSv1.0_SSH.

We note that the altimeter data contain other improved corrections, as specified in the MEaSURES documentation. Future orbit updates will be provided in 2012.

We continue to investigate the issue of orbit centering with regards to the use of DORIS, SLR, and most recently, GPS satellite tracking and the use of different TRF realizations of the tracking networks. Some recent analysis, which now includes Jason-2 GSFC GPS processing, has been presented at the OSTST 2011 and AGU 2011 Fall meetings (Melachroinos et al., 2011a, 2011b).

14.3 CRYOSAT-2 PROCESSING SUMMARY

The Cryosat-2 data has been processed systematically since June of 2010. A new attitude module to describe the analytical attitude profile of the spacecraft was implemented in GEODYN. This module was tested against quaternion data for Cryosat-2 supplied by E. Schrama (TU/Delft) (cf. see Schrama 2011, Fall AGU meeting). In Table 8, we summarize the RMS of fit for the SLR/DORIS processing of two series: the first using GGM03S, the second using a replacement set of gravity coefficients to degree and order 4 derived from SLR/DORIS processing to ten satellites (not including Cryosat-2). The gravity coefficients are derived weekly and smoothed using a five-week boxcar filter. The SLR & DORIS RMS of fit is summarized for the two series in Table 8 and in Figure 11. It is encouraging that the gravity series as applied to Cryosat-2 results in an improvement in POD performance.

Orbit Series	Narcs	SLR RMS of fit (cm)		DORIS RMS of fit (mm/s)	
		Avg.	Median	Avg.	Median
GGM03S (nominal)	84	1.97	1.92	0.4208	0.4212
1107_cs4x4	79	1.80	1.73	0.4187	0.4162

Table 8: Cryosat-2 RMS of fit for SLR/DORIS arcs (June 2010- Sept. 2011).

The improvement we see for Cryosat-2 using the new gravity time series, is very similar to the performance gain we observe for Envisat (see Table 9, Table 10), especially if we consider the same time period as for Cryosat-2 (cf. Table 8).

Orbit Series	Narcs	SLR RMS of fit (cm)		DORIS RMS of fit (mm/s)	
		Avg.	Median	Avg.	Median
GGM03S (nominal)	624	1.242	1.150	0.4835	0.4778
1107_cs4x4	624	1.160	1.080	0.4830	0.4771

Table 9: Envisat RMS of fit for SLR/DORIS arcs (2002.5-2011.8).

Orbit Series	Narcs	SLR RMS of fit (cm)		DORIS RMS of fit (mm/s)	
		Avg.	Median	Avg.	Median
GGM03S (nominal)	92	1.543	1.479	0.4949	0.4965
1107_cs4x4	92	1.341	1.331	0.4936	0.4949

Table 10: Envisat RMS of fit for SLR/DORIS arcs (2010/06/06-2011/10/02)

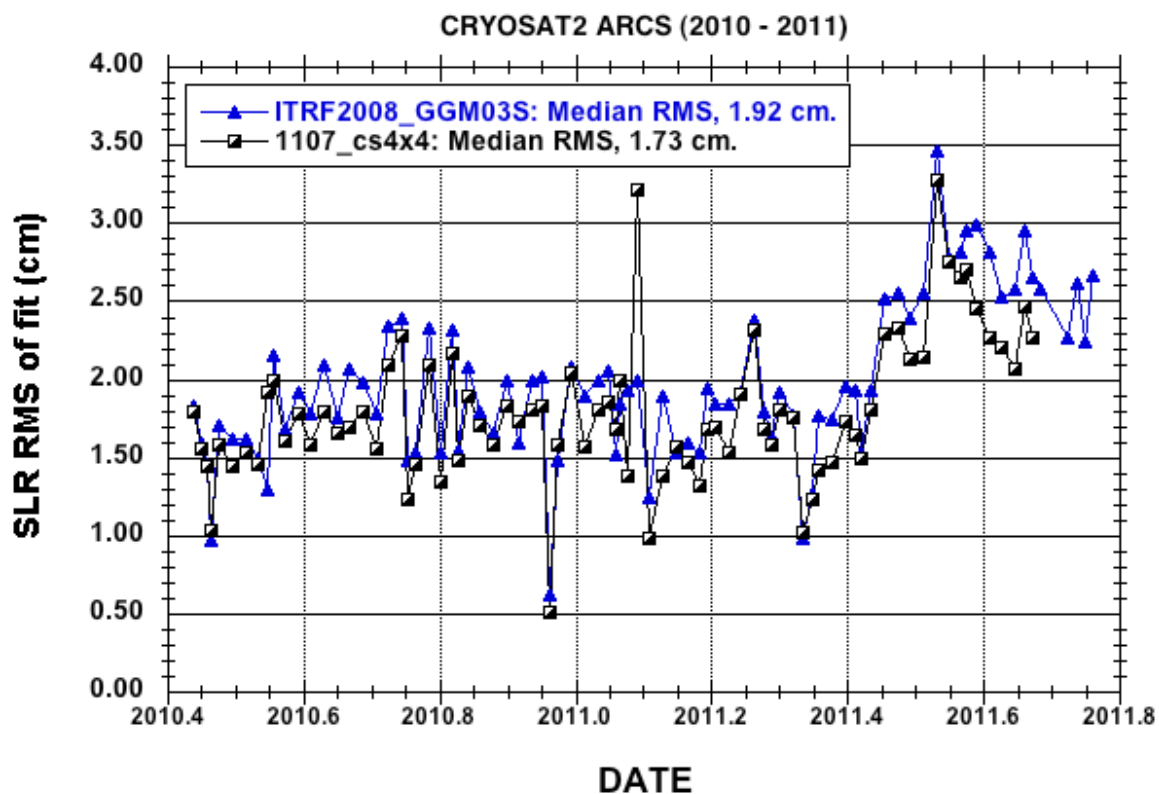

Figure 11: Cryosat-2 Arcs SLR RMS of fit for two orbit processing strategies (2010-2011)

In Figure 12 we illustrate the amplitude of the derived empirical accelerations in the along-track and cross-track accelerations. The OPR's are derived with respect to the CNES (trapezoidal prism-based) macromodel, and a nominal solar radiation reflectivity coefficient (C_r) of unity. They indicate a systematic signal that is likely due to radiation pressure mismodeling, and suggest a tuning of the macromodel would be beneficial.

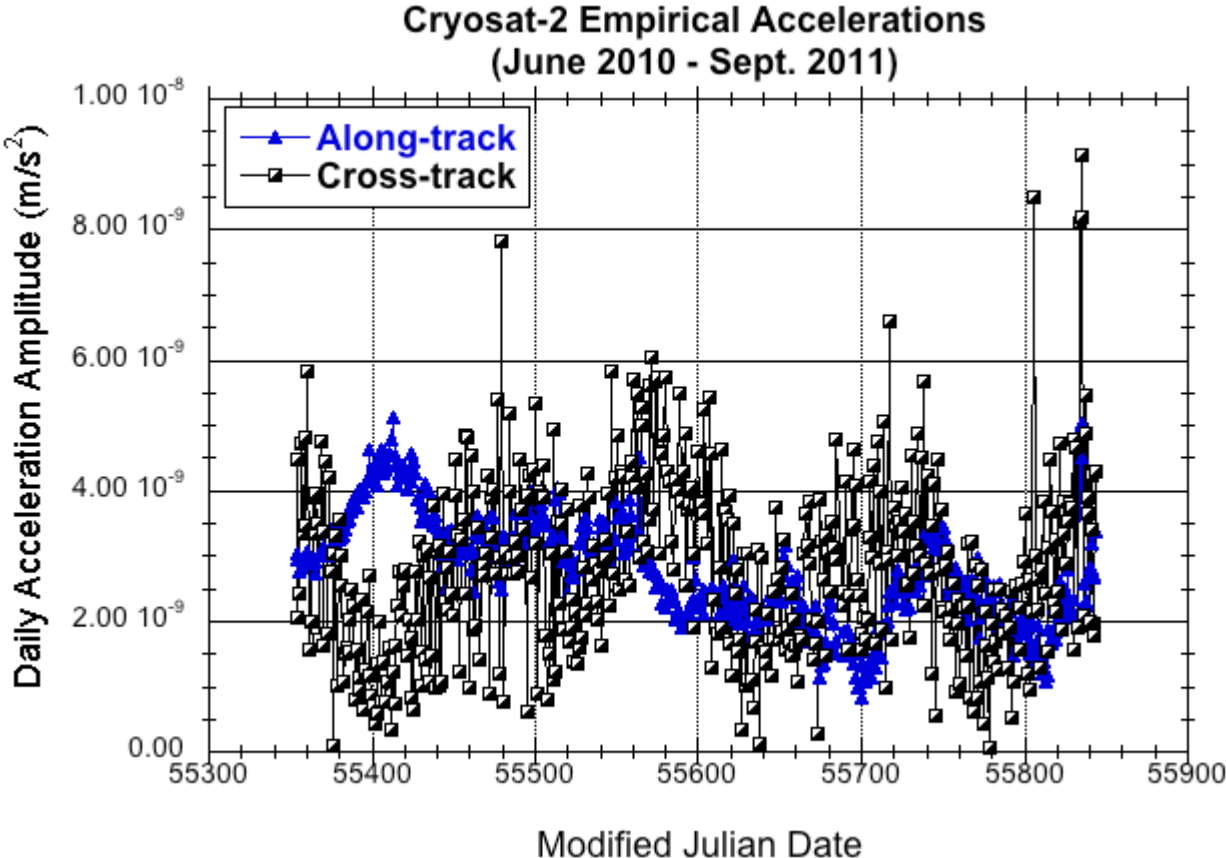

Figure 12: Cryosat-2 Daily Empirical Acceleration Amplitude (June 2010 to Sept. 2011).

15 REPORT OF THE IGN/JPL ANALYSIS CENTER (IGN)

Pascal Willis (1,2), Bruno Garayt (1)

(1) Institut Géographique National, France

(2) Institut de Physique du Globe de Paris France

15.1 CONTEXT

The Institut Géographique National uses the GIPSY/OASIS software package (developed by the Jet Propulsion Laboratory, Caltech, USA) to generate all DORIS products for geodetic and geophysical applications. In 2011, IGN used the most recent version (GOA 6.0) as installed in November 2010. This software package is installed on both sites at IGN in Saint-Mandé and at IPGP in Tolbiac. In 2010, all results were generated to IDS by the IPGP site. Computations are done routinely on a daily basis using a crontab command launching several scripts successively, first checking for new DORIS data availability. New solutions are then submitted simultaneously to both IGN and NASA/CDDIS data centers. Internal validation is done after the facts using an internal website available at IPGP, eventually leading to a few resubmissions of weekly SINEX solutions.

15.2 PRODUCTS DELIVERED IN 2011

The latest delivered IGN weekly time series is still ignwd08 (in free-network). However, a complete resubmission has been done in 2011 leading to the ignwd10 weekly solution (when transformed into ITRF2008). This is the solution that was used in preparation of ITRF2008 and available for combined solutions IDS-1, IDS-2 and IDS-3. It is the one still used by the IDS Combination Center. Models and strategy estimation remain unchanged but new SINEX solutions are generated every week (on average). Following the delivery of the ignwd10 solution, all derived products were also updated every week to be compatible with ITRF2008. At this point, products relying on ITRF2005 were discontinued, while products relying on ITRF2008 keep being submitted every week (see Table 11).

Besides these IDS products, several IGN results were also provided to the Analysis Coordinator for test purposes: satellite orbits in sp3 format, weekly SINEX solution by satellites, multi-satellites weekly SINEX solutions with or without Jason-2 data, satellites orbits for all satellites.

In 2011, a cumulative solution (position and velocity of all DORIS stations derived using the full DORIS data set available since 1993) was generated `tf_110727c` but was not provided in SINEX format, `ign09d02` still remains the latest available solution provided by the IGN group and available at the IDS data centers. New work was conducted toward the realization of a new DPOD2008 solution (terrestrial reference frame for precise orbit determination derived

from ITRF2008), for which several updates were delivered and are still available at the following website : <http://www.ipgp.fr/~willis/DPOD2008/>

Product	Latest version	Update	Data span	Number of files
Weekly SINEX				
- free-network	ignwd08	Weekly	1993.0-2011.9	989
- inITRF2005	ignwd09	Weekly	1993.0-2011.4	962 - stopped
- in ITRF2008	ignwd10	Weekly	1993.0-2011.9	989
- summary files	ignwd08	Weekly	1993.0-2011.9	989
STCD	ign09d01	Weekly	1993.0-2011.4	157 – stopped
	ign11d01	Weekly	1993.0-2011.9	158
Geocenter	ign09d01	Weekly	1993.0-2011.4	1 – stopped
	ign11d01	Weekly	1993.0-2011.9	1
EOPs	ign09d01	Weekly	1993.0-2011.4	1 –stopped
	ign11d01	Weekly	1993.0-2011.9	1

Table 11: IGN products delivered at IDS data centers in 2010. As of January 17, 2011.

Comparisons of DORIS-derived tropospheric zenith delays were also performed toward GPS PPP solutions (Bock et al., 2010). For test purposes, VMF-1 mapping function was also used during CONT08 campaign leading to tropospheric comparisons toward VLBI and GPS estimates (Teke et al., 2011). Systematic comparisons of horizontal tropospheric gradients were also generated with regards to GPS PPP solutions provided by Jet Propulsion Laboratory for the International GPS Service (Willis et al., 2012).

15.3 MAJOR IMPROVEMENTS IN 2011

Major improvements of the ignwd08 solution include :

- use of the more recent GGM03S gravity field (still without taking into account seasonal variations)
- rescaling of the solar radiation pressure models using an empirical coefficient determined using a large DORIS data set for each satellite (Gobinddass et al., 2009). This mitigates errors in the Z-geocenter at periods of 118 days and 1 year and also improve vertical component of high latitude stations.
- hourly estimation of drag coefficient for lower DORIS satellites at 800 km (Gobinddass et al., 2010). This avoids problem related to high geomagnetic activity (geomagnetic storm and maximum of 11-year solar cycle around 2001).
- use of GMF mapping function for tropospheric correction

15.4 NEW DEVELOPMENTS

In 2010, new data from Jason-2 and Cryosat2 were processed for test purposes, pointing out errors in initial data delivery. Data redelivered by CNES were reprocessed and products were delivered to IDS data

16 REPORT OF THE INASAN ANALYSIS CENTER (INA)

Sergey Kuzin, Suriya Tatevian (1)

(1) Institute of Astronomy Russian Academy of Sciences (INASAN), Russia

16.1 INTRODUCTION

In 2011, INASAN (ina) DORIS Analysis Center continued processing DORIS data using GIPSY-OASIS II software developed by JPL with updated DORIS part of GIPSY developed by IGN/JPL (Linux version). Table 12 summarizes current products delivered by INASAN to the IDS.

Product	Latest version	Span
SINEX weekly free-network solutions	inawd07	1993.0 - 2012.0
Geocenter time series	ina10wd01	1993.0 - 2012.0
EOP time series	ina10wd01	1993.0 - 2012.0
STCD time series	ina10wd01	1993.0 - 2010.8

Table 12: List of INASAN products provided to the IDS (January 2012).

The files with the product description can be found at:

1) SINEX series

ftp://cddis.gsfc.nasa.gov/pub/doris/products/sinex_series/inawd/inawd07.snx.dsc

2) Geocenter

<ftp://cddis.gsfc.nasa.gov/pub/doris/products/geoc/ina10wd01.geoc.dsc>

3) EOP-series

<ftp://cddis.gsfc.nasa.gov/pub/doris/products/eop/ina10wd01.eop.dsc>

4) STCD-series

<ftp://cddis.gsfc.nasa.gov/pub/doris/products/stcd/ina.stcd.readme>

16.2 SOFTWARE UPDATE AND ANALYSIS RESULTS DESCRIPTIONS

During 2011 the GIPSY-OASIS software were twice updated and currently we use the latest version 6.1.1. In this release the new IAU06 precession nutation model was added and uses as the new default, replacing the old IAU80. The new IERS2010 tidal displacement and tidal potential models were added and use as default models. Added or verified IERS2010 models for long-period, diurnal and semidiurnal tidal variations in polar motion, length of day and UT1. In GIPSY 6.1.1 release the new planetary ephemeris DE421 were used as default instead of old DE405. The user impact is negligible. The all other models are identical those reported in IDS_Report_2010.pdf. The two new satellites Cryosat-2 and Jason- are used in our weekly SINEX IDS submissions beginning from the second half of 2011.

For the goals of intercomparison nonconservative forces between different ACs and orbits satellite-by-satellite compare well-established reference frame, the DORIS measurements were processed for 2010 only for all available satellites (SPOT-4, SPOT-5, Envisat, Jason-2, Cryosat-2). Daily once per revolution acceleration amplitudes in along and cross track directions as well as sp3 orbit files were obtained and sent to analysis coordinator for further investigations.

Weekly free-network solutions, obtained after merging daily free-network solutions, have been used for the calculations of all products. Each weekly SINEX file contains stations coordinates and EOP. After the transformation of free-network solutions into a well-defined reference frame ITRF2005 (more exactly into the long-term cumulative ign09d02 solution), the standard deviations of station coordinates were estimated at the level 0.5-4.0 cm, depending on the number of satellites used in the solution.

Estimated annual geocenter variations for 1993.0-2012.0 were derived by least squares method and evaluated as 5.4±0.2 mm, 4.2±2.0 mm, 2.3±1.1 mm, for X, Y and Z components, respectively (respect to ITRF2005, more exactly respect to ign09d02 - global DORIS solution).

17 REPORT OF THE CNES/CLS ANALYSIS CENTER (LCA)

Laurent Soudarin (1), Hugues Capdeville (1), Jean-Michel Lemoine (2)

(1) CLS, France

(2) CNES/GRGS Groupe de Recherche en Géodésie Spatiale, France

17.1 INTRODUCTION

The CNES and CLS participate jointly to the International DORIS Service (IDS) as an Analysis Center. The processing of the DORIS data is performed using the GINS/DYNAMO software package developed by the GRGS.

The main activity during 2011 was to review of the attitude models implemented in GINS, to update the set of models used in the data processing and to reprocess the whole data set.

17.2 DATA PROCESSING AND PRODUCTS DELIVERED TO IDS

The routine processing was carried on up to the end of June. Three different series of SINEX files, corresponding to three different combinations, were delivered to IDS (see Table 13).

- lcawd24: SPOT-4 + SPOT-5 + Envisat, in the continuity of the series used for IDS-3;

- lcawd26: SPOT-4 + SPOT-5 + Envisat+ Jason-2 (from lca08363wd26.snx)

- lcawd28: SPOT-4 + SPOT-5 + Envisat+ Jason-2 + Cryosat-2

(from lca10164wd28.snx).

The last weekly SINEX supplied for these series are those of the last week of April 2011 (lca11114). The series lcawd26 and lcawd28 were used by the Combination Center to evaluate the successive contributions of Jason-2 and Cryosat.

Orbits files in sp3c format were made available at the IDS Data Centers for each DORIS mission, including Jason-1. These are DORIS+SLR mixed orbits for Envisat, TOPEX/Poseidon, Cryosat-2 and the two Jason satellites, and DORIS-only orbits for the SPOT satellites. The new file name convention indicating the technics used for the orbit determination was applied for all the files supplied from January 2011.

In addition to these products, we also provided to the Analysis Coordination weekly single satellite SINEX for Cryosat-2, SPOT-4, SPOT-5, Envisat, and Jason-2 for June 2010 – March 2011. The files can be found in pub/doris/products/2010campaign/lcawd/

Product	Series	Data span
SINEX weekly free-network	lcawd24 lcawd26 (with Jason2) lcawd28 (with Jason2 and Cryosat2)	1993.0-2011.
Orbit files	lca01.sp3	SPOT-4: 2008/12 -2011/04 SPOT-5: 2008/12 -2011/04 Envisat: 2008/12 -2011/04 Jason-1: 2010/10 – 2011/04 Jason-2: 2008/12 - 2011/04 Cryosat-2: 2010/ - 2011/04

Table 13: List of the CNES/CLS products supplied in 2011, and the total data span of each

17.3 REPROCESSING

In 2011, a complete reprocessing has been done to take into account upgrades brought to the software and the modeling, since the configuration set up for IDS-3 (IDS solution contributing to ITRF2008 computation).

The GINS 11.2d1 version we used includes revised attitude laws for TOPEX/Jason-1/Jason-2, Envisat and Cryosat-2 (see below). A bug related to the frequency bias was also fixed.

Changes were brought to the set of models. Compared to the previous series lcawd20, 24, 26, 28, we use:

- DPOD2008 as a priori instead of DPOD2005
- IERS EOP series aligned on ITRF2008
- GMF/GPT tropospheric model instead of zenith delay derived from ECMWF meteorological model and Guo&Langley mapping function
- EIGEN-6S gravity model instead of EIGEN-GL04S

For low orbit DORIS satellites (SPOTs, Envisat and Cryosat-2 orbiting under 900 kms), the number of air drag coefficients is increased during high solar activity periods: 1 coef/1 hour instead of 1 coef/4 hours. This strategy is applied in particular for the period: November 1998 to December 2003

Solar Radiation Pressure coefficients (SRP) are kept fixed to mean values while the matrices are reduced:

0.98 for TOPEX

1.15 for SPOT-2

1.16 for SPOT-3

1.16 for SPOT-4

1.17 for SPOT-5

1.29 for Envisat

0.97 for Jason-2

0.85 for Cryosat-2

A new macro-model tuned by GRGS Toulouse team is used for Jason-2. The phase wind-up effect has been implemented in GINS and is used in the data processing. The atmospheric loading correction is not applied.

The products of the reprocessing (weekly SINEX, SP3c orbits, STCD) were provided to IDS Data Centers in early 2012. A description file can be found at CDDIS (<ftp://cddis.gsfc.nasa.gov/>) and IGN (<ftp://doris.ensg.ign.fr/>) in:

pub/doris/products/sinex_series/lcawd/lcawd30.snx.dsc

17.4 CORRECTION AND VALIDATION OF THE ATTITUDE MODELS

The nominal attitude models of TOPEX/Jasons and Envisat implemented in GINS have been revised. The method we applied to check our satellite attitude models has been presented in a poster at EGU General Assembly 2011. It is based on the comparison between our GINS orbits and the ZOOM POE orbits determined by CNES POD team. It consists in analyzing the time evolution of the vector between the center of phase and the center of mass obtained from the difference between orbits determined at the satellite mass center and orbits determined at the reference center. This study allowed us to revise the nominal attitude models in GINS for Jason-1, Jason-2 and Envisat, and to get a good agreement between GINS and ZOOM at the level of 1-2 mm for the three orbit components.

17.5 JASON-2 “TWO- CHANNEL LIKE”

On the request of the Analysis Coordination, we did a special processing of the Jason-2 data using two channels only, like Jason-1, and compared with the results using all the 7 channels of Jason-2's DGXX instrument. The objective was to ascertain if the strengthening in the determination of the Z component of the geocenter is due to the orbit geometry (i.e. inclination), or the availability of more data, or both.

Our approach was as follow. From the launch of Jason-2, in June 2008 up to February 2009, the both satellites Jason-1 (2 channels) and Jason-2 (7 channels) were on the same orbit with 55-second shift. We use Jason-1's station acquisition sequence to select the data in Jason-2's files that we processed then to determine the orbit and perform weekly solutions. The study shows that the decreasing number of channels from 7 to 2 has no significant impact on Jason-2's orbit determination. But different results are obtained for the geocenter. The 7 channels allow indeed to reduce the bias of the Z component (w.r.t ITRF2008) and to obtain a better stability with time.

17.6 PLANS FOR 2012

The routine production of the lcawd30 series and its associated products will be carried on in 2012. HY-2A will be taken into account in the data analysis as soon as its measurements are available.

18 REFERENCES

- Beckley, B.D., Lemoine, F.G., Luthcke S.B., et al. (2007), A reassessment of TOPEX and Jason-1 altimetry based on revised reference frame and orbits, *Geophys. Res. Lett.*, 34, L14608, doi:10.1029/2007GL030002.
- Beutler G, Rothacher M, Schaer S, Springer TA, Kouba J, Neilan RE (1999), The International GPS Service (IGS), an interdisciplinary service in support of sciences. *Adv Space Res* 23(4):631-653, DOI: 10.1016/S0273-1177(99)00161-1
- Boehm, J., Niell, A.E., Tregoning, P., and Schuh, H (2006), The Global Mapping Function (GMF): A new empirical mapping function based on data from numerical weather model data, *Geophys Res Lett* 33:L07304, doi:10.1029/2005GL025546.
- Capdeville H., Soudarin L., Lemoine J.-M.. DORIS orbit determination and validation at CNES/CLS Analysis Center - An approach to validate satellite attitude models, Abstract EGU2011-6049, poster presented at the EGU General Assembly, Vienna, Austria, 03 - 08 April 2011.
- Cerri, L., Mercier, F. Berthias, J.P., et al. (2010), Precision orbit determination standards for the Jason series of altimeter missions. *Marine Geodesy special issue on the Jason-1/Jason-2 mission calibration and tandem mission*, *Marine Geodesy*, submitted
- Doornbos E. (2001) Modeling of non-gravitational forces for ERS-2 and Envisat, Delft Institute for Earth-Oriented Space Research, Delft University of Technology, Delft, The Netherlands.
- Förste, C., Schmidt, R., Stubenvoll, R., et al. (2008), The GeoForschungsZentrum Potsdam/Groupe de Recherche de Géodésie Spatiale satellite-only and combined gravity field models, EIGEN-GL04S1 and EIGEN-GL04C, *J. Geod.*, 82(6), pp. 331-346.
- Goad, C.C. and Goodman, L. (1974), A modified Hopfield tropospheric refraction correction model, AGU Annual Fall Meeting, San Francisco, CA, 1974.
- Gobinddass, M.L., Willis, P., de Viron, O., et al. (2009), Systematic biases in DORIS-derived geocenter time series related to solar radiation pressure mismodelling, *J. Geod.*, 83(9), 849-858.
- Govind, R., Valette, JJ., Lemoine, F.G. A DORIS Determination of the Absolute Velocities of the Sorsdal and Mellor Glaciers in Antarctica, *Advances in Space Research*, doi:10.1016/j.asr.2010.02.011, (2010a).
- Govind, R., Lemoine, F.G., Valette, JJ., Chinn, D., Zelensky, N. Towards ITRF2008: DORIS High Precision Geodesy, submitted, *DORIS Special Issue, Advances in Space Research*, (2010b).
- Haines BJ, Bar-Sever YE, Bertiger WI, Desai S, Willis P (2004), One-Centimeter Orbit Determination for Jason-1, *New GPS-Based Strategies. Marine Geod* 27(1-2):299-318, DOI: 10.1080/01490410490465300

- Knocke, P., J. Ries, and B. Tapley (1988). Earth radiation pressure effects on satellites. Proc. Of AIAA/AAS Astrodynamics Conference, Minneapolis, MN, 15–17 August 1988.
- Le Bail K., Lemoine, F., and D.S. Chinn (2010), GSFC DORIS contribution to ITRF2008, *Adv. Space Res.*, doi:10.1016/j.asr.2010.01.030.
- Lemoine, F.G., Zelensky N.P. Chinn, D.S., et al. (2010), Towards development of a consistent orbit series for TOPEX/Poseidon, Jason-1 and Jason-2, *Adv. Space Res.*, DORIS Special Issue, In review.
- Luthcke SB, Zelensky NP, Rowlands DD, Lemoine FG, Williams TA (2003), The 1-Centimeter Orbit: Jason-1 Precision Orbit Determination using GPS, SLR, DORIS and Altimeter Data. *Marine Geod* 26(3-4):399-421
- Lyard, F., Lefevre, F., Letellier, T., et al. (2006), Modelling the global ocean tides, *Modern insights from FES2004*, *Ocean Dyn.*, 56(5-6), 394-415.
- Marshall, J.A., Zelensky, N.P., Klosko, S.M., et al. (1995), The temporal and spatial characteristics of TOPEX/POSEIDON radial orbit error. *J Geophys Res.*, 100(C12), pp. 25331-25352, doi:10.1029/95JC01845.
- McCarthy, D.D., and Petit, G. (2004), *IERS Conventions (2003)*, IERS Technical Note 32, Frankfurt am Main: Verlag des Bundesamts für Kartographie und Geodäsie, ISBN 3-89888-884-3.
- Moreaux, G., et al. Impact of Jason-2 and Cryosat-2 on DORIS Combination, presented, American Geophysical Union Spring Meeting, 2011.
- Niell, A.E. (1996), Global mapping functions for the atmosphere delay at radio wavelengths, *J Geophys Res* 101(B2), pp. 3227-3246, 1996.
- Pearlman MR, Degnan JJ, Bosworth JM (2002), The International Laser Ranging Service. *Adv Space Res* 30(2):135-143, doi: 10.1016/S0273-1177(02)00277-6
- Ray, R.D., A global ocean tide model from TOPEX/Poseidon Altimetry: GOT99.2, NASA TM-1999-209478, NASA Goddard Space Flight Center, September 1999:(Updated).
- Ray R.D., Luthcke, S.B., and Boy, J.P. (2009), Qualitative comparisons of global ocean tide models by analysis of intersatellite ranging data, *J. Geophys. Res.*,114, C09017, doi:10.1029/2009JC005362.
- Ries J.C. (2008), LPOD2005: a practical realization of ITRF2005 for SLR-based POD, presentation, OSTST 2008, Nice., France, November 2008.
- Rummel R, Rothacher M, Beutler G (2005). Integrated Global Geodetic Observing System (IGGOS), Science rationale. *J Geodyn* 40(4-5):355-356, doi:10.1016/j.jog.2005.06.003
- Sibthorpe, A. (2006), Precision non-conservative force modelling for low Earth orbiting spacecraft, Ph.D. Thesis, Univ. of London, London, U.K.
- Schluter W, Himwich E, Nothnagel A, Vandenberg N, Whitney A (2002), IVS and its important role in the maintenance of the global reference systems. *Adv Space Res* 30(2):145-

150, doi:10.1016/S0273-1177(02)00278-8

Tavernier G, Soudarin L, Larson K, Noll C, Ries J, Willis P (2002), Current status of the DORIS Pilot Experiment and the future International DORIS Service. *Adv Space Res* 30(2):151-156, doi: 10.1016/S0273-1177(02)00279-X

Tavernier G, Granier JP, Jayles C, Sengenés P, Rozo F (2003), The current evolution of the DORIS system. *Adv Space Res* 31(8):1947-1952, doi:10.1016/S0273-1177(03)00155-8

Valette, J.J., Lemoine, F.G., Ferrage, P., et al. (2010), IDS contribution to ITRF2008, *Adv. Space Res.*, DORIS Special Issue, submitted.

Willis P, Bar-Sever Y, Tavernier G (2005), DORIS as a potential part of a Global Geodetic Observing System, *J Geodyn*, 40(4-5), 494-501, doi:10.1016/j.jog.2005.06.011

Willis, P., Haines BJ, Berthias JP, Sengenés P, and J. Le Mouél, Comportement de l'oscillateur DORIS/Jason au passage de l'anomalie sud-atlantique, *C. R. Geoscience*, 336(9), 839 – 846, doi:10.1016/j.crte.2004.01.004, 2004.

Willis, P., Ries, J.C., Zelensky, N.P., et al. (2009), DPOD2005, An extension of ITRF2005 for Precise Orbit Determination, *Adv. Space Res.*, 44(5), pp. 534-545.

Yaya, P. and Valette, J.J. (2009), Evaluation of the IDS combination through analysis of the station performances, IDS Analysis Working Group Meeting, 23-24 March 2009, Paris, France, URL: <http://ids-doris.org/report/meeting-presentations/ids-awg-03-2009.html>.

Zelensky, N.P., Lemoine, F.G., Chinn, D.S., et al. (2010), DORIS/SLR POD modelling improvements for Jason-1 and Jason-2, *Adv. Space Research*, DORIS Special Issue, In review.

Zelensky, N.P., Berthias, J.P., Lemoine, F.G., DORIS time bias estimation using Jason-1, TOPEX/Poseidon and Envisat orbits, *J. Geodesy*, 80, 497-506, doi: 10.1007/s00190-006-0075-3

Ziebart, M., Adhya, S., and Sibthorpe, A. (2005), Combined radiation pressure and thermal modelling of complex satellites: Algorithms and on-orbit tests, *Adv. Space Research*, 36(3), pp. 424-430.

19 PUBLICATIONS (2011)

Here is below the list of DORIS publications in international peer-reviewed journals for 2011.

The complete list is available on the IDS website:

http://ids-doris.org/report/publications/peer-reviewed_journals.html

Altamimi, Z.; Collilieux, X.; Métivier, L., 2011. ITRF2008: An improved solution of the International Terrestrial Reference Frame, JOURNAL OF GEODESY, 85(8):457-473, DOI: [10.1007/s00190-011-0444-4](https://doi.org/10.1007/s00190-011-0444-4) **Open access**

Dettmering, D.; Heinkelmann, R.; Schmidt, M., 2011. Systematic differences between VTEC obtained by different space-geodetic techniques during CONT08, JOURNAL OF GEODESY, 85(7):443-451, DOI: [10.1007/s00190-011-0473-z](https://doi.org/10.1007/s00190-011-0473-z)

Fadil, A.; Sichoix, L.; Barriot, J.P.; Ortéga, P.; Willis, P., 2011. Evidence for a slow subsidence of the Tahiti Island from GPS, DORIS, and combined satellite altimetry and tide gauge sea level records, COMPTES RENDUS GEOSCIENCES, 343(5):331-341, DOI: [10.1016/j.crte.2011.02.002](https://doi.org/10.1016/j.crte.2011.02.002)

Flohrer, C.; Otten, M.; Springer, T.; Dow, J., 2011. Generating precise and homogeneous orbits for Jason-1 and Jason-2, ADVANCES IN SPACE RESEARCH, 48(1):152-172, DOI: [10.1016/j.asr.2011.02.017](https://doi.org/10.1016/j.asr.2011.02.017)

Siefring, Carl L.; Bernhardt, Paul A.; Koch, Douglas E.; Galysh, Ivan J., 2011. Using TEC and radio scintillation data from the CITRIS radio beacon receiver to study low and midlatitude ionospheric irregularities, RADIO SCIENCE, 46, Art. RS0D19, DOI: [10.1029/2010RS004585](https://doi.org/10.1029/2010RS004585)

Teke, K.; Böhm, J.; Nilsson, T.; Schuh, H.; Steigenberger, P.; Dach, R.; Heinkelmann, R.; Willis, P.; Haas, R.; Garcia-Espada, S.; Hobiger, T.; Ichikawa, R.; Shimizu, S., 2011. Multi-technique comparison of troposphere zenith delays and gradients during CONT08, JOURNAL OF GEODESY, 85(7), 395-413, DOI: [10.1007/s00190-010-0434-y](https://doi.org/10.1007/s00190-010-0434-y)

Yin, P.; Mitchell, C.N., 2011. Demonstration of the use of the Doppler Orbitography and Radio positioning Integrated by Satellite (DORIS) measurements to validate GPS ionospheric, ADVANCES IN SPACE RESEARCH, 48(3):500-506, DOI: [10.1016/j.asr.2011.04.010](https://doi.org/10.1016/j.asr.2011.04.010)

APPENDIX 1: THE IDS INFORMATION SYSTEM

1 WHAT AND WHERE

IDS has three data/information centers:

CB: the Central Bureau web and ftp sites at CLS

DC: the Data Center(s): * CDDIS: web and ftp sites * IGN: ftp site

AC: the Analysis Coordinator webpages on the CB website

The baseline storage rules are as follows:

DC store observational data and products + formats and analysis descriptions.

CB produces/stores/maintains basic information on the DORIS system, including various standard models (satellites, receivers, signal, reference frames, etc.).

AC refers to CB and DC information on the data and modeling, and generates/stores analyses of the products.

Two criteria are considered for deciding where files are stored/maintained:

1. the responsibility on their content and updating,
2. the easiness of user access.

Data-directed software is stored and maintained at the CB, analysis-directed software is stored/maintained, or made accessible through the AC webpages.

To avoid information inconsistencies, duplication is minimized. Logical links and cross referencing between the three types of information centers is systematically used.

A description of the data structure and formats is available at:

<http://www.ids-doris.org/analysis-documents/struct-dc.html>

2 WEB AND FTP SITES

2.1 IDS WEBSITE

address : <http://ids-doris.org> (or <http://www.ids-doris.org>)

The IDS website gives general information on the Service, provides access to the DORIS system pages on the AVISO website, and hosts the Analysis Coordination pages.

It is composed of three parts:

- “IDS” describes the organization of the service and includes documents, access to the data and products, event announcements, contacts and links.
- “DORIS System” allows to access general description of the system, and gives information about the system monitoring and the tracking network.
- “Analysis Coordination” provides information and discussion areas about the analysis strategies and models used in the IDS products. It is maintained by the Analysis Coordinator with the support of the Central Bureau.
- It is supplemented by a site map, a glossary, FAQs, a history of site updates, news on the IDS and news on DORIS.

The main headings of the “IDS” parts are:

- Organization: structure of the service, terms of reference, components
- Data and Products: information and data center organization, access information to the IDS Data Centers and to the Central Bureau ftp site.
- Meetings: calendars of the meetings organized by IDS or relevant for IDS, as well as links to calendars of other international services and organizations.
- Reports and Mails: documents of the IDS components, DORIS bibliography including DORIS-related peer-reviewed publications and citation rules, meeting presentations, mail system messages, etc.
- Contacts and links: IDS contacts, directory, list of websites related to IDS activities
- Gallery (photo albums from local teams and IDS meetings).

The headings of the “DORIS system” part are:

- Official website: a description of the DORIS system on the AVISO website
- Network: Site logs, station coordinate time series, maps, network on Google Earth.

- System monitoring: DORIS system events file, station events file, station performance plots from the CNES MOE and POE processing, list of events impacting the data.
-

The headings of the “Analysis Coordination” part are:

- Documents: about the DORIS system’s components (space segment, ground segment, stations, observations), the models used for the analysis, the products and their availability. A direct access to this regularly-visited page is also given in the “IDS” part.
- DORIS related events: history of the workshops, meetings, analysis campaigns, etc.
- Discussion: archive of the discussions before the opening of the forum.
- Software: a couple of software provided by the Analysis Coordinator.

DORIS and IDS news as well as site updates are accessible from the Home page. Important news is displayed in the new box “Highlights”. The lists of news about the DORIS system and IDS activities (also widely distributed through the DORISmails) are resumed respectively in the two headings “What’s new on DORIS” (<http://ids-doris.org/doris-news.html>) and “What’s new on IDS” (<http://ids-doris.org/ids-news.html>). The history of the updates of the website is given in “Site updates” (<http://ids-doris.org/site-updates.html>).

The IDS website is maintained by the Central Bureau.

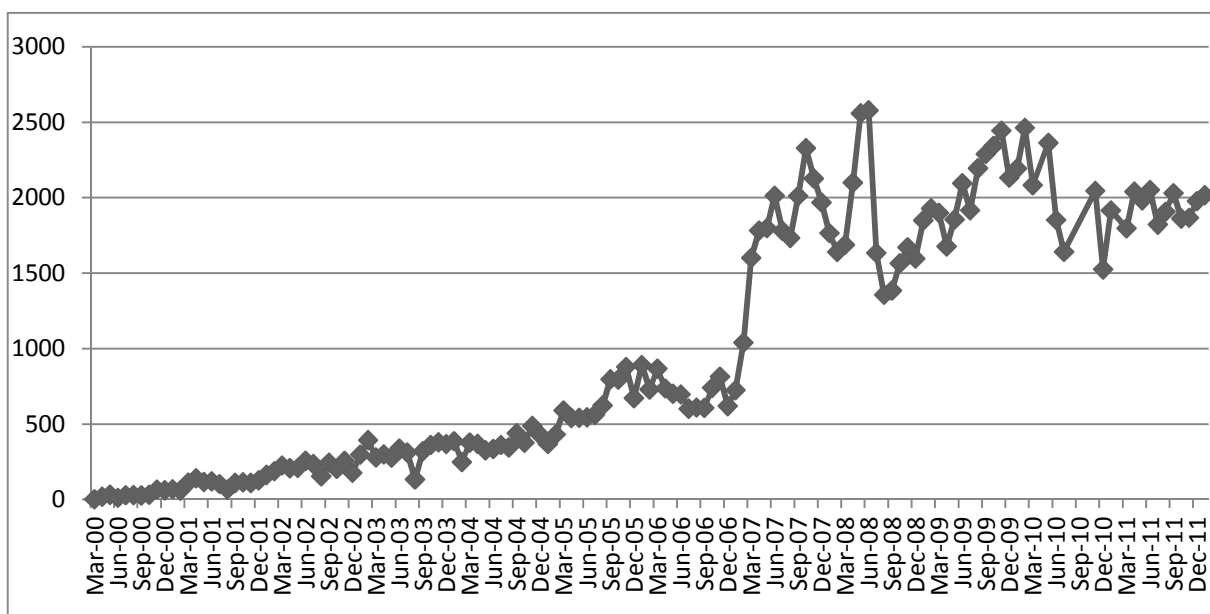

IDS website number of access per month (CNES and CLS excluded).

2.2 IDS FTP SERVER

address: <ftp://ftp.ids-doris.org/pub/ids>

The IDS ftp server gives information on the DORIS system, and provides analysis results from the Analysis Coordination's combination center.

The documents available concern:

- the centers: presentation and analysis strategy of the ACs;
- the DORIS data: format description 1.0,2.1, 2.2, and RINEX, POE configuration for GDRB and GDRC altimetry products from Jason-1 and Envisat, on-board programming and POE pre-processing history;
- the DORISmails and DORISreports: archive of the messages in text format, and indexes;
- the products: format of eop, geoc, iono, snx, sp1, sp3, stcd;
- the satellites: macromodels, nominal attitude model, center of mass and center of gravity history, maneuver history (including burn values), instrument modeling, corrective model of DORIS/Jason-1 USO frequency, plots of the POE statistics of all the stations for each satellite;
- the stations: ties, seismic events around the DORIS station network, ITRF2000, antennas description, beacon RF characteristics, information about the frequency shifts of the 3rd generation beacon, IDS recommendations for ITRF2005, Jason and Spot-4 visibility, station events, plots of the POE statistics of all the satellites for each station, document about the interface specification between the DORIS Network beacons and the onboard instrument;
- the combinations: analysis results from Analysis Coordination's combination center (internal validation of each individual Analysis Center time series, weekly combination), IDS combination for the DORIS contribution to ITRF2008.
- ancillary data such as bus quaternions and solar panel angles of Jason-1 and Jason-2

The IDS ftp site is maintained by the Central Bureau.

There is a mirror site at CDDIS: ftp://cddis.gsfc.nasa.gov/pub/doris/cb_mirror/

and at IGN: ftp://doris.ensg.ign.fr/pub/doris/cb_mirror/

2.3 DORIS WEBSITE

Address: <http://www.aviso.oceanobs.com/en/doris/index.html>

The official DORIS website is hosted by the Aviso website which is dedicated to altimetry, orbitography and precise location missions. The DORIS pages present the principle of the system, its description (instruments onboard, ground beacons, control and processing center, system evolutions, Diode navigator), the applications and the missions. The site is maintained by the Aviso webmaster with the support of the IDS Central Bureau.

2.4 DATA CENTERS' WEBSITES

Data and products, formats and analysis descriptions are stored at the CDDIS and IGN Data Centers. A detailed description is given in the report of the Data flow Coordinator.

Address of the CDDIS website: http://cddis.gsfc.nasa.gov/doris_summary.html

Address of the CDDIS ftp site: <ftp://cddis.gsfc.nasa.gov/pub/doris/>

Address of the IGN ftp site: <ftp://doris.ensg.ign.fr/pub/doris/>

3 THE MAIL SYSTEM

The mail system of the IDS is one of its main communication tools. Depending on the kind of the information, mails are distributed through the DORISmail, DORISreport, DORISstations or IDS.analysis.forum. The mails of these four lists are all archived on the mailing list server of CLS. Back-up archives of the text files are also available on the Central Bureau ftp server for the DORISmails and the DORISreports.

A description of the mailing lists can be found on the IDS website on the page: <http://ids-doris.org/report/mails.html>

Dedicated mailing lists were also created for the Central Bureau, the Governing Board and the Analysis Working Group, but without archive system.

3.1 DORISMAIL

e-mail: dorismail@ids-doris.org

The DORISmails are used to distribute messages of general interest to the users' community (subscribers). The messages concern:

- Network evolution: installation, renovation...
- Data delivery: lack of data, maneuver files
- Satellite status

- Status of the Data Centers
- Meeting announcements
- Calls for participation
- delivery by Analysis Centers
- etc.

The messages are moderated by the Central Bureau.

They are all archived on the mailing list server of CLS at the following address:
<http://lists.ids-doris.org/sympa/arc/dorismail>

They are also available in text format on the IDS ftp site:

<ftp://ftp.ids-doris.org/pub/ids/dorismail/>

3.2 DORISREPORT

e-mail : dorisreport@ids-doris.org

This list is used for regular reports from Analysis Centers, from the Analysis coordination and from the CNES POD team. The DORISReport distribution list is composed by Analysis Centers, Data Centers, IDS Governing Board and Central Bureau, CNES POD people delivering data to the Data Centers (subscribers).

They are all archived on the mailing list server of CLS at the following address:

<http://lists.ids-doris.org/sympa/arc/dorisreport>

They are also available in text format on the IDS ftp site:

<ftp://ftp.ids-doris.org/pub/ids/dorisreport/>

The list is moderated by the Central Bureau and the CNES POD people.

3.3 DORISSTATIONS

e-mail : dorisstations@ids-doris.org

This mailing list has been opened to distribute information about station events (data gap, positioning discontinuities).

The messages are archived on the mailing list server of CLS at the following address:

<http://lists.ids-doris.org/sympa/arc/dorisstations>.

The archive contains also the mails distributed on the analysis forum before the creation of the dedicated list.

3.4 IDS ANALYSIS FORUM

e-mail : ids.analysis.forum@ids-doris.org

In order to share in the present, and secure for the future, information, questions and answers on the problems encountered in the DORIS data analysis, the Analysis Coordinator with the support of the Central Bureau initiated the IDS Analysis Forum. This a list for discussion of DORIS data analysis topics (stations, satellites, DORIS instruments, data, analysis, orbits, EOP, products) moderated by the Analysis Coordination.

The messages are all archived on the mailing list server of CLS at the following address:

<http://lists.ids-doris.org/sympa/arc/ids.analysis.forum>

Previous to the creation of forum, the Analysis Coordinator has collected 68 messages of conversation between analysts in an archive that can be viewed at <http://www.ids-doris.org/analysis-discussion.html>

3.5 OTHER MAILING LISTS

ids.central.bureau@ids-doris.org: list of the Central Bureau

ids.governing.board@ids-doris.org: list of the Governing Board

ids.cbgb@ids-doris.org: common list for the Central Bureau and the Governing Board. This list is private.

ids.awg@ids-doris.org: list of people who attend the AWG, and/or analysis center representatives.

4 HELP TO THE USERS

e-mail : ids.central.bureau@ids-doris.org

The contact point for every information requirement is the Central Bureau. It will find a solution to respond to user's need. A list of contact points has been defined for internal use depending on the kind of questions.

APPENDIX 2: DORIS STATIONS COLOCATION WITH TIDE GAUGES

The table and the figure below are courtesy provided by the « Système d'Observation du Niveau des Eaux Littorales » (SONEL, Université de La Rochelle, France). They are regularly updated at the following address:

<http://www.sonel.org/stations/cgps/survey/survey.doris.html>

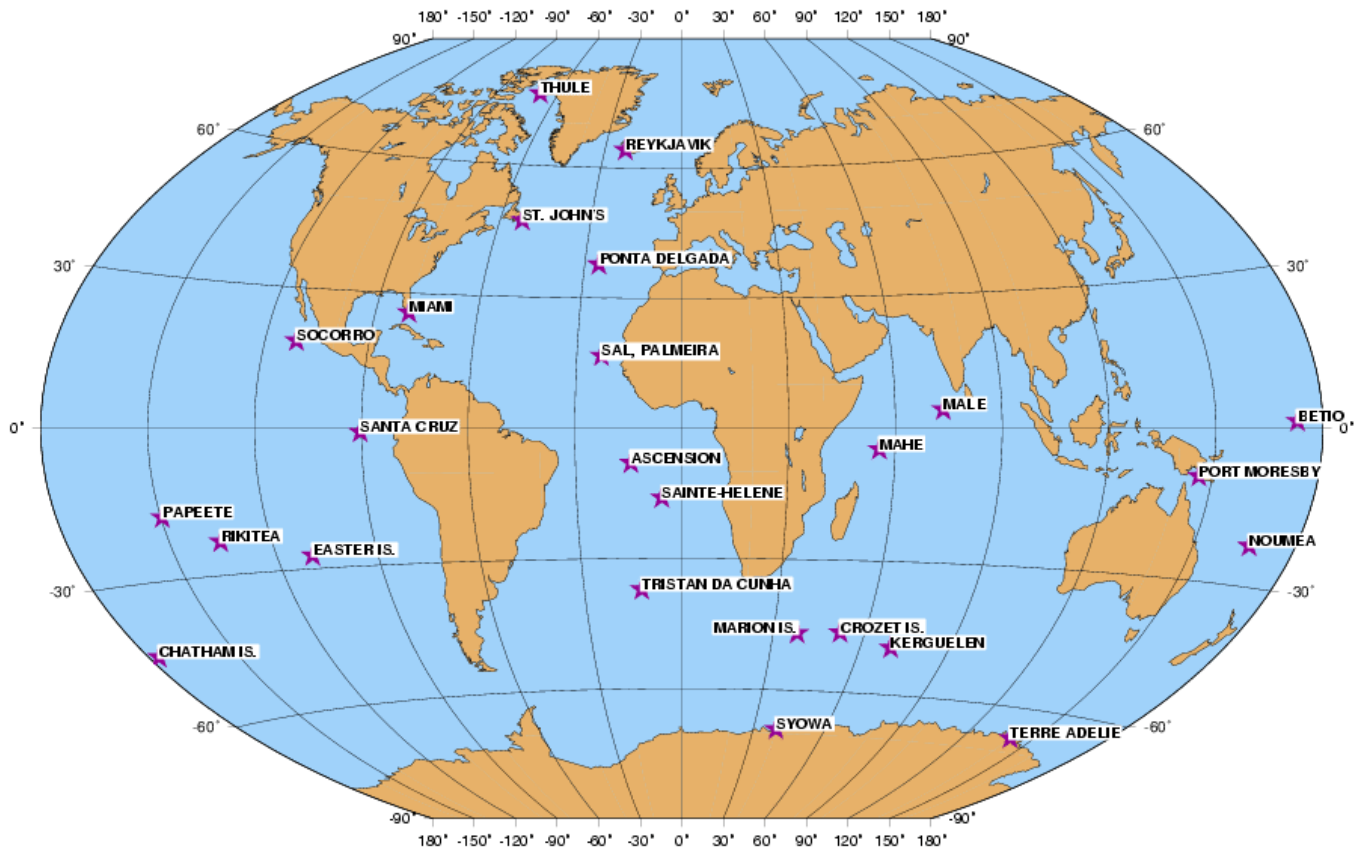

DORIS Name	Longitude	Latitude	Country	Start date	Distance	GLOSS id	PSMSL id
ASCENSION	-14.33	-7.92	UK	1997-02-28	6500	263	402001
BETIO	172.92	1.35	KIRIBATI	2006-10-22	1600	113	730009
CHATHAM ISLAND	-176.57	-43.96	NEW ZEALAND	1999-02-28	1200	128	-----
COLOMBO	79.87	6.89	SRI LANKA	1991-06-06	5000	033	520001
CROZET ISLAND	51.85	-46.43	FRANCE	2003-12-21	850	21	433001
EASTER ISLAND	-109.38	-27.15	CHILI	1988-11-17	7000	137	810003
KERGUELEN	70.26	-49.35	FRANCE	1987-01-28	3300	023	434001
MAHE	55.53	-4.68	SEYCHELLES	2001-06-20	300	273	442007
MALE	73.53	4.20	MALDIVES	2005-01-15	500	28	454011
MARION ISLAND	37.86	-46.88	SOUTH AFRICA	1987-05-15	1000	020	-----
MIAMI	-80.17	25.73	USA	2005-02-10	180	---	960001
NOUMEA	166.41	-22.27	FRANCE (CALEDONIA)	1987-10-20	3600	123	740001
PAPEETE	-149.61	-17.58	FRANCE (POLYNESIA)	1995-07-27	7000	140	780011
PONTA DELGADA	-25.66	37.75	PORTUGAL (AZORES)	1998-11-02	1500	245	36002
PORT MORESBY	146.18	-9.43	PAPUA NEW GUINEA	1988-03-29	6000	---	670012
REYKJAVIK	-21.99	64.15	ICELAND	1990-07-04	2500	229	010001
RIKITEA	-134.97	-23.13	FRANCE (POLYNESIA)	2006-09-23	800	138	808001
SAINTE-HELENE	-5.72	-15.92	UK	2011-01-25	-	264	425001
SAL	-22.98	16.78	CAPE VERDE	2002-12-15	7000	329	380021
SANTA CRUZ	-90.30	-0.75	ECUADOR	2005-04-01	1600	---	845031
SOCORRO	-110.95	18.73	MEXICO	1989-06-09	400	162	830062
ST. JOHN'S	-52.68	47.40	CANADA	1999-09-27	4000	223	970121
SYOWA	39.58	-69.01	JAPAN (ANTARCTICA)	1993-02-10	1000	095	A--041
TERRE ADELIE	140.00	-66.67	FRANCE (ANTARCTICA)	1987-02-05	500	131	-----
THULE	-68.83	76.54	DENMARK (GREENLAND)	2002-09-28	300	---	-----
TRISTAN DA CUNHA	-12.30	-37.05	UK	2011-02-01	2000	266	-----

APPENDIX 3: DORIS STATIONS / HOST AGENCIES

Station name	Institute	City, Country
Amsterdam	Institut Polaire Paul Emile Victor (IPEV)	Base Martin-de-Viviès, île Amsterdam, Sub-Antarctica, FRANCE
Arequipa	Universidad Nacional de San Agustin (UNSA)	Arequipa, PERU
Ascension	ESA Telemetry & Tracking Station	Ascension Island, South Atlantic Ocean, UK
Badary	Badary Radio Astronomical Observatory (BdRAO, Institute of Applied Astronomy)	Republic of Buryatia, RUSSIA
Belgrano	Instituto Antártico Argentino (DNA)	Buenos Aires, ARGENTINA
Betio	Kiribati Meteorological Service	Republic of KIRIBATI
Cachoeira Paulista	Instituto Nacional de Pesquisas Espaciais (INPE)	Cachoeira Paulista, BRAZIL
Chatham Island	MetService	Chatham Island, NEW ZEALAND
Cibinong	BAKOSURTANAL	Cibinong , INDONESIA
Cold Bay	National Weather Service NOAA	Cold Bay, Alaska, USA
Cold Bay	US Coast Guard Navigation Center (NAVCEN)	Alexandria, Virginia, USA
Crozet	Institut Polaire Paul Emile Victor (IPEV)	Base Alfred Faure, archipel de Crozet, Sub-Antarctica, FRANCE
Dionysos	National Technical University Of Athens (NTUA)	Zografou, GREECE
Djibouti	Observatoire Géophysique d'Arta (CERD)	Arta, Republic of DJIBOUTI
Easter Island	SSC Chile S.A.	Santiago, CHILI
Everest	Comitato Ev-K2-CNR	Bergamo, ITALY
Futuna	Météo-France	Malae, Wallis-et-Futuna, FRANCE
Grasse	Observatoire de la Côte d'Azur (OCA)	Grasse, FRANCE
Gavdos	Technical University of Crete (TUC)	Chania, Crete, GREECE
Greenbelt	NASA / GSFC / GGAO	Greenbelt, Maryland, USA
Hartebeesthoek	HartRAO, South African National Space Agency (SANSA)	Hartebeesthoek, SOUTHAFRICA

Station name	Institute	City, Country
Jiufeng	Institute of Geodesy and Geophysics (IGG)	Wuhan, CHINA
Kauai	Kokee Park Geophysical Observatory (KPGO)	Kauai Island, Hawaiï, USA
Kerguelen	Institut Polaire Paul Emile Victor (IPEV)	Base de Port-aux-Français, archipel de Kerguelen, Sub-Antarctica, FRANCE
Kitab	Department of geodynamics of Astronomical Institute	Kitab, UZBEKISTAN
Kourou	Centre Spatial Guyanais (CSG)	Kourou, FRENCH GUYANA
Krasnoyarsk	Siberian Federal University (SibFU)	Krasnoyarsk, RUSSIA
La Réunion	Observatoire Volcanologique du Piton de La Fournaise (IPGP)	Ile de la Réunion, FRANCE
Libreville	ESA tracking station	N'Koltang, GABON
Mahé	Seychelles National Meteorological Services	Mahé Island, Republic of SEYCHELLES
Male	Maldives Department of Meteorology	Male, Republic of MALDIVES
Manille	National Mapping and Ressource Information Authority (NAMRIA)	Republic of the PHILIPPINES
Marion	Antartica & Islands Department of Environmental Affairs(DEA)	Marion Island Base, SOUTH AFRICA
Metsahovi	Finnish Geodetic Institute (FGI)	Masala, FINLAND
Miami	Rosenstiel School of Marine and Atmospheric Science (RSMAS)	Rickenbacker Causeway, Florida, USA
Mount Stromlo	SLR Observatory, Geoscience Australia (GA)	Mount Stromlo, AUSTRALIA
Nouméa	Direction des Infrastructures, de la Topographie et des Transports Terrestres (DITTT)	Nouméa, NEW CALEDONIA
Ny-Alesund	Institut Polaire Paul Emile Victor (IPEV) Geodesiobservatoriet (Statens Kartverk)	Base Charles Rabot, Ny-Ålesund, NORWAY
Papeete	Observatoire Géodésique de Tahiti (OGT / UPF)	Fa'a, Tahiti, FRENCH POLYNESIA
Ponta Delgada	Universidade dos Açores	Ponta Delgada, Azores, PORTUGAL
Port Moresby	National Mapping Bureau (DLPP)	Port-Moresby, PAPUA NEW GUINEA
Reykjavik	Landmælingar Islands (LMI)	Reykjavik, ICELAND
Rikitea	Météo-France	Archipel des Gambier, Polynésie Française, FRANCE

Station name	Institute	City, Country
Rio Grande	Estacion Astronomica Rio Grande (EARG)	Rio Grande, ARGENTINA
Rothera	British Antarctic Survey (BAS)	Rothera Research Station, Adelaide Island, Antarctica, UK
Sal	Instituto Nacional de Meteorologia e Geofisica (INMG)	Sal Island, CAPE VERDE
Santiago	Santiago Satellite Station SSC Chile S.A.	Santiago, CHILI
Santa Cruz	Charles Darwin Foundation (AISBL)	Santa Cruz Island, Galapagos, ECUADOR
Socorro	Instituto Nacional de Estadística y Geografía (INEGI) Secretaría de Marina Armada (SEMAR)	Aguascalientes, MEXICO Socorro Island, MEXICO
St John's	Geomagnetic Observatory , Natural Resources Canada (NRCan)	St. John's, CANADA
St-Helena	Meteorological Station	St Helena Island, South Atlantic Ocean, UK
Syowa	National Institute of Polar Research (NIPR)	Syowa Base, Antarctica, JAPAN
Terre Adélie	Institut Polaire Paul Emile Victor (IPEV)	Base de Dumont d'Urville, Terre-Adélie, Antarctica, FRANCE
Thule	US Air Force Base National Survey and Cadastre (KMS)	Pituffik, Greenland, DENMARK Copenhagen, DENMARK
Tristan da Cunha	Telecommunications Department of TDC	Tristan da Cunha Island, South Atlantic Ocean, UK
Yarragadee	MOBLAS 5 SLR Station, Geoscience Australia (GA)	Yarragadee, AUSTRALIA
Yellowknife	Natural Resources Canada (NR Can)	Yellowknife CANADA
Yuzhno-Sakhalinsk	Institute of Marine Geology & Geophysics (IMGG)	Yuzhno-Sakhalinsk, RUSSIA



Arequipa



Dionysos



Male



Manille



Port Moresby



Punta Delgada



Saint Helena



Yuzhno-Sakhalinsk

**Pictures of local teams from some agencies hosting a DORIS station
(see <http://ids-doris.org/gallery.html>)**



IDS

www.ids-doris.org

**INTERNATIONAL
DORIS
SERVICE**



Contacts

Governing Board

Chairperson: Pascal Willis (IGN/ IPGP) willis@ipgp.jussieu.fr

Central Bureau

Laurent Soudarin (CLS) laurent.soudarin@cls.fr

Pascale Ferrage (CNES) pascale.ferrage@cnes.fr

Analysis coordinator

Frank Lemoine (NASA/GSFC) frank.g.lemoine@nasa.gov

Data flow coordinator

Carey Noll (NASA/GSFC) carey.noll@nasa.gov

Network

Bruno Garayt (IGN) bruno.garayt@ign.fr

Jérôme Saunier (IGN) jerome.saunier@ign.fr

