

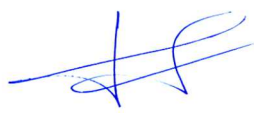
## SWOT

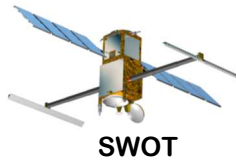
Reference: SWOT-NT-SYS-2191-CNES

Issue : 1

Date : 26/10/2023

### SWOT CHARACTERISTICS FOR POD PROCESSING

<b>Written by :</b> CNES SWOT System Engineer - Nathalie STEUNOU	<b>Date :</b>	
<b>For application:</b> CNES SWOT Project Manager – Pierre Sengenes	<b>Date :</b> 30/10/2023	



Reference : SWOT-NT-SYS-2191-CNES  
Issue : 1  
Date : 26/10/2023  
Page : 0/47

## INDEX SHEET

CONFIDENTIALITY : DL

KEYWORDS : SWOT, POD, DORIS, LRA, GPSP

TITLE : SWOT inputs for POD processing

AUTHOR(S) : Nathalie Steunou

SUMMARY : This document contains the different inputs that are needed for POD processing

RELATED DOCUMENTS : Stand alone document.

LOCALIZATION :

Volume :


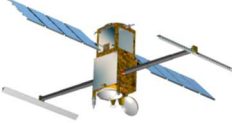
TOTAL NUMBER OF PAGES :

LANGUAGE : EN

CONFIGURATION  
MANAGEMENT : no

CM RESP. :

REASONS FOR EVOLUTION : First version

	 <b>SWOT</b>	Reference : SWOT-NT-SYS-2191-CNES Issue : 1 Date : 26/10/2023 Page : 1/47
--	---	--

**DOCUMENTATION CHANGE RECORD**

Issue.	Rev.	Dates	Pages	Modifications	Visa
0	0	10/08/2017		Creation of the document	
1	0	26/10/2023	All	Final update (intermediate preliminary version delivered in December 2022)	

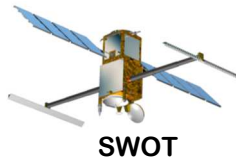


Reference : SWOT-NT-SYS-2191-CNES  
Issue : 1  
Date : 26/10/2023  
Page : 2/47

## TABLE OF CONTENTS

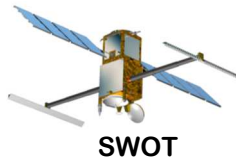
### Contents

TABLE OF CONTENTS .....	2
TABLE OF FIGURES .....	4
TABLE OF TABLES .....	5
1. INTRODUCTION .....	7
2. SWOT TO POD INTERFACE OVERVIEW .....	8
2.1. INTERFACES .....	8
2.1.1. Overview .....	8
2.1.2. Detailed interfaces for POD processing .....	9
2.2. MISSION CONTEXT .....	9
2.3. SATELLITE OVERVIEW .....	10
2.4. MISSION PHASE AND ORBIT CHARACTERISTICS .....	12
2.4.1. Mission phases .....	12
2.4.2. Orbits parameters .....	13
2.5. ORBIT MANEUVERS .....	14
2.5.1. Acquisition of fast-repeat orbit .....	14
2.5.2. Orbit change (from fast-repeat orbit to science orbit) .....	14
2.5.3. Station keeping .....	14
2.5.4. Calibration maneuvers .....	15
2.5.5. Yaw flips .....	15
2.5.6. Timeline for instruments switch-on .....	15
3. SATELLITE DESCRIPTION .....	17
3.1. SATELLITE REFERENCE FRAME .....	17
3.2. MASS PROPERTIES .....	18
3.2.1. Initial mass .....	18
3.2.2. In flight initial mass .....	18
3.3. SATELLITE CENTER OF MASS COORDINATES .....	19
3.3.1. Initial in flight satellite CoG .....	19
3.3.2. In flight modeled variations .....	21
3.3.3. In flight knowledge .....	24
3.4. ATTITUDE ERRORS REQUIREMENTS .....	25
3.5. MECHANICAL DISTURBANCES .....	25
3.5.1. Solar array rotation .....	25
3.5.2. Thermal snap .....	26
3.6. SATELLITE SURFACES .....	26
3.7. SATELLITE EXTERNAL GEOMETRY .....	27
3.8. THERMAL FLUX ASSUMPTIONS .....	32
4. INSTRUMENTS PARAMETERS USED FOR POD PROCESSING .....	33
4.1. SATELLITE AND KMSF REFERENCE FRAMES RELATION .....	33
4.2. POD INSTRUMENT ANTENNAS LOCATION .....	33



Reference : SWOT-NT-SYS-2191-CNES  
Issue : 1  
Date : 26/10/2023  
Page : 3/47

4.3. DORIS PARAMETERS.....	34
<b>4.3.1. Doris antenna phase center.....</b>	<b>34</b>
<b>4.3.2. Doris antenna phase laws.....</b>	<b>36</b>
4.4. GPSP PARAMETERS.....	36
<b>4.4.1. GPSP antenna phase center.....</b>	<b>36</b>
<b>4.4.2. GPSP phase law.....</b>	<b>38</b>
4.5. LRA PARAMETERS.....	39
<b>4.5.1. LRA optical center.....</b>	<b>39</b>
4.6. OPTICAL CORRECTION.....	40
4.7. ACCURACIES ON LRA-TO-COM VECTOR KNOWLEDGE.....	42
4.8. POSEIDON-3C PARAMETERS.....	42
<b>DISTRIBUTION.....</b>	<b>45</b>



Reference : SWOT-NT-SYS-2191-CNES  
Issue : 1  
Date : 26/10/2023  
Page : 4/47

## TABLE OF FIGURES

Figure 2-1	Flow diagram for Attitude and POD products (DR10) .....	8
Figure 2-2	Satellite Overview in deployed configuration (source : DR5) .....	12
Figure 2-3	Mission phases .....	13
Figure 2-4	Summarized 1 <sup>st</sup> month calendar timeline (version Launch – 13 days).....	15
Figure 2-5	Detailed PL Turn ON .....	16
Figure 3-1	Satellite axes.....	17
Figure 3-2	SC and PL reference frames .....	18
Figure 3-3	Initial satellite mass and centering assumptions .....	20
Figure 3-4	SA command orientation as a function of beta angle .....	23
Figure 3-5	Effect of SA variation on SA CoM position .....	23
Figure 3-6	Solar array CoM expected variations wrt solar array angle, in Y and Z axes.....	24
Figure 3-7	Overall dimensions of the SWOT Satellite in deployed configuration (SQR).....	28
Figure 3-8	Payload module components (© SIR Review Presentation) .....	29
Figure 3-9	Nadir Payload module .....	30
Figure 3-10	Payload module in AIT.....	30
Figure 3-11	Satellite in AIT.....	31
Figure 4-2	GPSP accommodation .....	34
Figure 4-3	SWOT LRA .....	39
Figure 4-4	LRA field of view (FOV) and coordinate system. The Z-axis of the LRA reference frame points toward nadir.	41
Figure 4-5	Pos3C antenna reference plan definition .....	43

## TABLE OF TABLES

Table 2-1	Mean orbit characteristics (from DR1) .....	13
Table 3-1:	Satellite initial mass, details .....	18
Table 3-2	Sublevel and satellite mass and CoG values in Satellite reference frame .....	19
Table 3-3	Initial Center of Mass positions in KMSF and SAT reference frame .....	20
Table 3-4	Center of Mass positions in KMSF and SAT reference frame at the beginning of Science Phase 21	
Table 3-5	Doris ZQS_0503 inputs .....	21
Table 3-6	Doris ZQS_0504 and ZQS_0505 inputs .....	21
Table 3-7	Satellite assumptions for ergol budget (preflight) .....	22
Table 3-8	Solar array wings center of mass position in satellite reference frame as a function of SADM angle	24
Table 3-9	Attitude errors requirements .....	25
Table 3-10	Satellite surface and properties (same as in DR9) .....	26
Table 3-11	Surface thermal properties .....	27
Table 4-1	KMSF reference frame in satellite reference frame .....	33
Table 4-2	Doris antenna reference frame origin .....	35
Table 4-3	Accuracies on Doris-to-CoM vector knowledge .....	35
Table 4-4	GPSP antenna phase center in antenna reference frame .....	37
Table 4-5	GPSP antenna reference in KMSF: position .....	37
Table 4-6	GPSP antenna reference in KMSF : orientation .....	37
Table 4-7	Accuracies on GPSP-to-CoM vector knowledge .....	38
Table 4-8	Position of origin of LRA reference frame in the KaRIn Metering Structure Frame (KMSF). Units are mm.	40
Table 4-9	Orientation of the LRA in the KaRIn Metering Structure Frame. ....	40
Table 4-10	Position of LRA optical center in the LRA reference frame. Units are mm.....	40
Table 4-11	Retroreflector Array Coordinates. Units are m and radians. ....	42
Table 4-12	Accuracies on LRA-to-CoM vector knowledge .....	42
Table 4-13	Nadir altimeter antenna reference frame position and rotation in KMSF .....	43
Table 4-14	Nadir altimeter measurement reference position in KMSF .....	43



Reference : SWOT-NT-SYS-2191-CNES  
Issue : 1  
Date : **26/10/2023**  
Page : 6/47

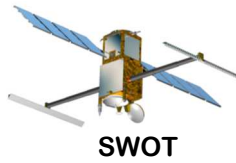
## APPLICABLE AND REFERENCE DOCUMENTS

Reference	Document title
DR1 SWOT-TN-SYS-0162-CNES	SWOT MISSION ANALYSIS
DR2 SWOT-TN-SYS-1418-CNES	SWOT OPERATIONAL MISSION ANALYSIS
DR3 SWOT-TS-SYS-434-CNES	SWOT L2 level coordinate systems and conventions specification
DR4 SWOT-DJ-SYS-0423-CNES	SWOT Inputs for POD processing – Justification of the requirements and budgets
DR5 SWOT-TAS-F-AN-0284	Precise Orbit Determination Analyses reports
DR6 SWOT-TAS-F-BT-0286	SWOT Satellite performances and Budgets
DR7 SRL-SYS-NT-066-CNES	SARAL characteristics for Doris Calibration Plan and POD Processing
DR8 S3-ID-TAF-SC-01290	Sentinel-3 satellite to Precise Orbit Determination Interface Control Document
DR9 DSW-PL-DO-EA-16937-CN	Doris calibration plan
DR10 SWOT-DJ-SYS-2305-CNES	SWOT Ephemerids, center of mass, attitude : Justification of the products definition and interfaces
DR11 SWO-MS-ICD-421-CNES	SWOT mission system interfaces control document
DR12 Slides June 2021	L3b-Payload POD Requirement Verification
DR13 SWOT-TAS-F-IC-0424	Platform to GPSP Mechanical ICD
DR14 SWOT-TAS-F-AN-1197	Inputs for modeling Observatory CoG position in flight

## ABBREVIATIONS

Sigle	Definition
CoM	Center of Mass
DORIS	Doppler Orbitography by Radiopositioning Integrated on Satellite
GPS	Global Positioning System
JPL	Jet Propulsion Laboratory
KaRIn	Ka-band Radar Interferometer
LRA	Laser Retroreflector Array
MOE	Medium Orbit Ephemeris
NA	Nadir Altimeter
POD	Precise Orbit Determination
POE	Precise Orbit Ephemeris
SLR	Satellite Laser Ranging
SWOT	Surface Water Ocean Topography





Reference : SWOT-NT-SYS-2191-CNES  
Issue : 1  
Date : **26/10/2023**  
Page : 7/47

## 1. INTRODUCTION

---

This document defines the relevant parameters for the interface between the SWOT spacecraft and the Precise Orbit Determination and on-board orbit determination process to be applied in the corresponding processing center.

It summarizes the satellite characteristics that are needed for the processing of Doris, GPSP and LRA measurements to produce the orbit ephemerids.

This issue is based on all latest AIT measurement in the POD related performances demonstration as presented during Satellite Qualification Review and in SQR datapack (see Issue 6 of DR5 and Issue 2 of DR14).

## 2. SWOT TO POD INTERFACE OVERVIEW

### 2.1. INTERFACES

#### 2.1.1. Overview

Figure 2-1 illustrates the different interfaces for ground processing.

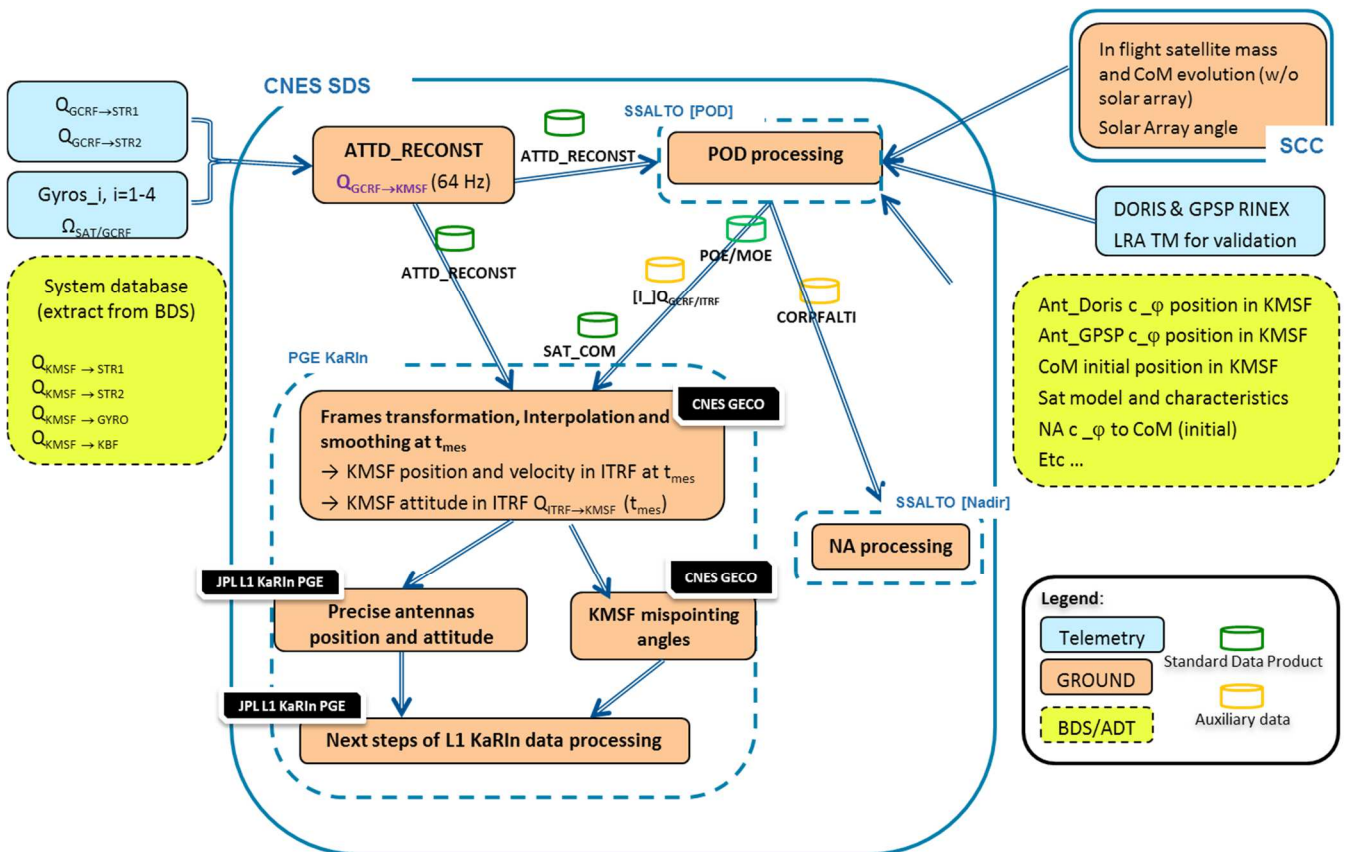

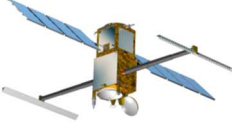


Figure 2-1 Flow diagram for Attitude and POD products (DR10)

Main points are:

- POD is part of SSALTO in CNES SDS.
- POD system generates standard data products, including POE/MOE and SAT\_COM (satellite center of mass, including solar arrays), and intermediate products [I\_Q\_GCRF\_ITRF (GCRF to ITRF quaternions) products that are used for science processing.
- The ATTD\_RECONST product, issued from GYRO and STR ground data fusion, will be provided to POD
- SCC provides inflight satellite mass and COM evolution without solar array processed by FDS (in KMSF)
- SCC provides solar array angle through HKTM-PARAM interface
- SCC provides the list of events

	 <p style="text-align: center;"><b>SWOT</b></p>	Reference : SWOT-NT-SYS-2191-CNES Issue : 1 Date : <b>26/10/2023</b> Page : 9/47
---	---	---

## 2.1.2. Detailed interfaces for POD processing

Details on the interfaces between SCC/FDS and SDS can be found in DR11.

- CONSTRAINTS: provides the mission center with time slot where KaRIn measurements shall not be processed because of manoeuvres, gyro calibration, ... Production frequency : asynchronous
- MAN-COM-MASS: provides the mission center with an historic file containing all maneuvers thrusts that have been performed since launch and all maneuvers that are predicted at the moment. Predicted information shall be used before the maneuver, while restituted one shall be used after the maneuver.

MAN-COM-MASS values are provided in KMSF reference frame.

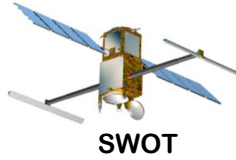
Historic file is computed each time it must be sent in order to always contain the most up-to-date information for each thrust (both restituted and predicted). It contains:

- the time at the middle of the thrust
  - Thrust delta V
  - Center of Mass (without SA)
  - Mass (without SA)
- HKTM-PARAM : provides solar panel positions and currents, produced once a day
  - ECLIPSE: contains predicted slots of on-orbit events (light/shadow/penumbra transitions) that might have an impact on the science data processing (slots during which measurements could be of poor quality or should not be processed). It also contains Sun by Moon eclipses.
  - HISTO\_OEF: contains the predicted start and end dates of each event that might have an impact on science data processing (orbit control maneuvers, satellite temporarily not on the reference altitude, yaw flip, gyro calibrations and solar panels move). This interface will group gyro calibration, yaw flip and commanded OCM thrusts and SADM cruise (start/stop for each EVENT). It contains dates history from the start of mission. It is produced and delivered once a day, and covers up to 2 weeks after the date of production.
  - Note that POD processing generates a satellite center of mass product (SAT\_COM) that provides the satellite center of mass in the KMSF frame including solar arrays and their orientation. The SAT\_COM file is used for science data processing.

## 2.2. MISSION CONTEXT

The Surface Water and Ocean Topography (SWOT) mission is a cooperative project between NASA and CNES. The SWOT mission is devoted to cover the world's oceans and freshwater bodies with repeated water surface elevation measurements. Both the surface water hydrology and ocean surface topography communities recognize the importance of wide-swath altimetry for its capability of acquiring high-resolution water surface elevation measurements. The main instrument of the payload is a Ka-band Radar Interferometer (KaRIn), an interferometric imaging radar altimeter operating in Ka-band.

The Surface Water Ocean Topography mission brings together two communities focused on a better understanding of the world's oceans and its terrestrial surface waters. Our understanding of the oceanic circulation at mesoscales and smaller, where most of the ocean's kinetic energy and its dissipation takes place, is poor. Likewise, the role of internal tides as sources of mixing as well as coastal processes such as upwelling, jets, and fronts are not well understood. Given the basic need for fresh water, the most important hydrologic observations that can be made in a basin are of the temporal and spatial variations in water volumes stored in rivers, lakes, and wetlands. Unfortunately, we have poor knowledge of the global dynamics of terrestrial surface waters as well as their interactions with coastal oceans in estuaries. Thus, the SWOT Satellite Mission and its wide-swath altimetry technology has been proposed as a means for completely covering the world's oceans and freshwater bodies with repeated elevation



Reference : SWOT-NT-SYS-2191-CNES  
Issue : 1  
Date : 26/10/2023  
Page : 10/47

measurements.

The main science objectives for both communities are:

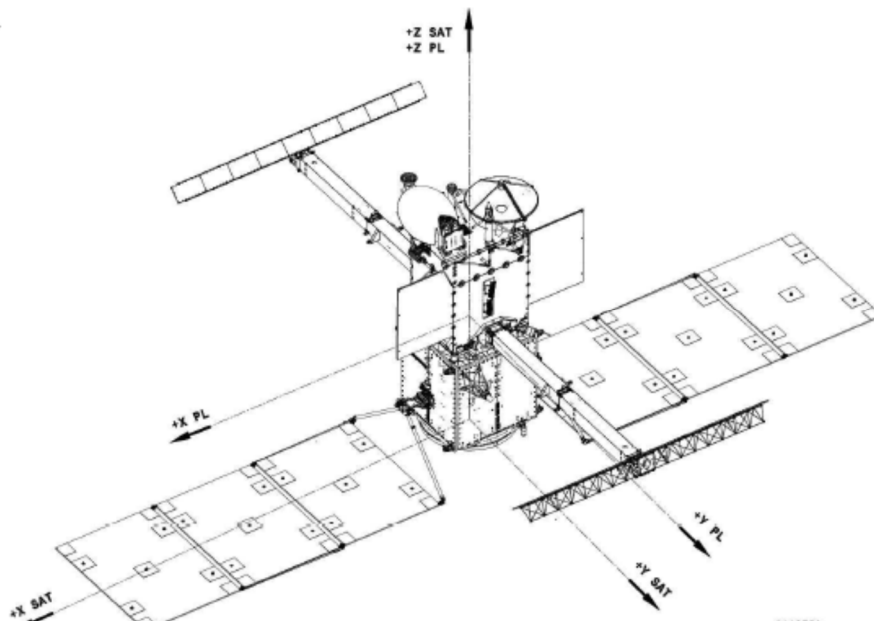
- **Oceanography:** To characterize the ocean mesoscale and submesoscale circulation determined from the ocean surface topography at spatial resolutions of 15 km (for 68% of the ocean). (Spatial resolution is defined to be wavelength in the oceanographic context.)

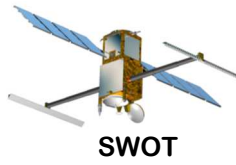
- **Hydrology:**

- To provide a global inventory of all terrestrial surface water bodies whose surface area exceeds  $(250\text{m})^2$  (goal:  $(100\text{m})^2$ ) (lakes, reservoirs, wetlands) and rivers whose width exceeds 100m (goal: 50m).
- To measure the global storage change in terrestrial surface water bodies at sub-monthly, seasonal, and annual time scales.
- To estimate the global change in river discharge at sub-monthly, seasonal, and annual time scales.

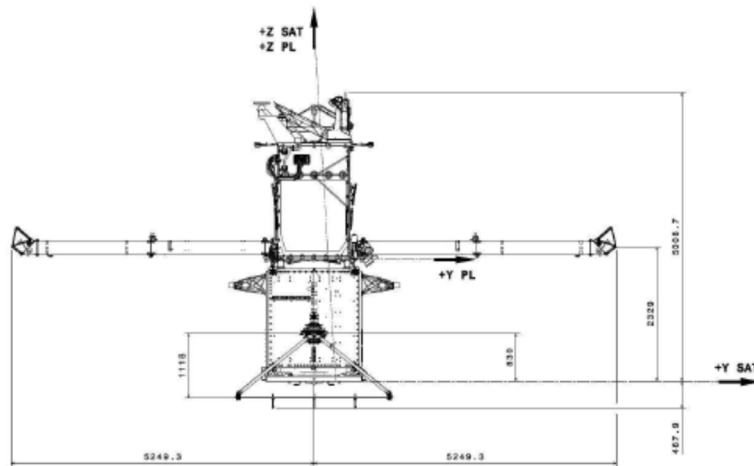
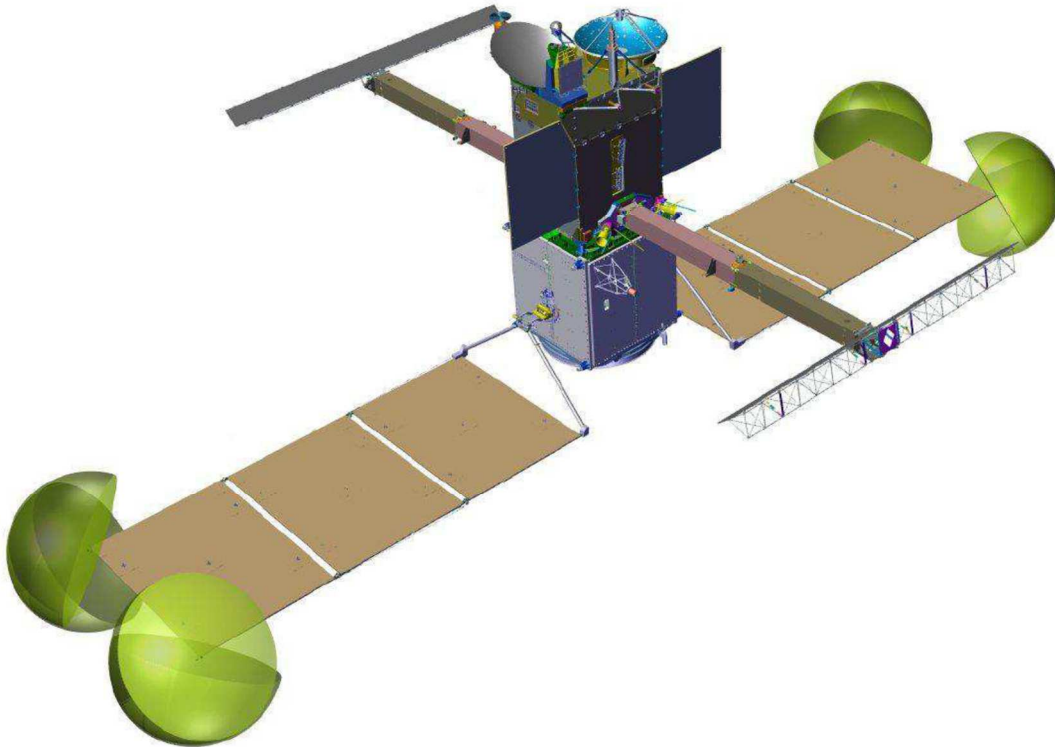
## 2.3. SATELLITE OVERVIEW

The satellite design in its fully deployed configuration is represented on the following views.



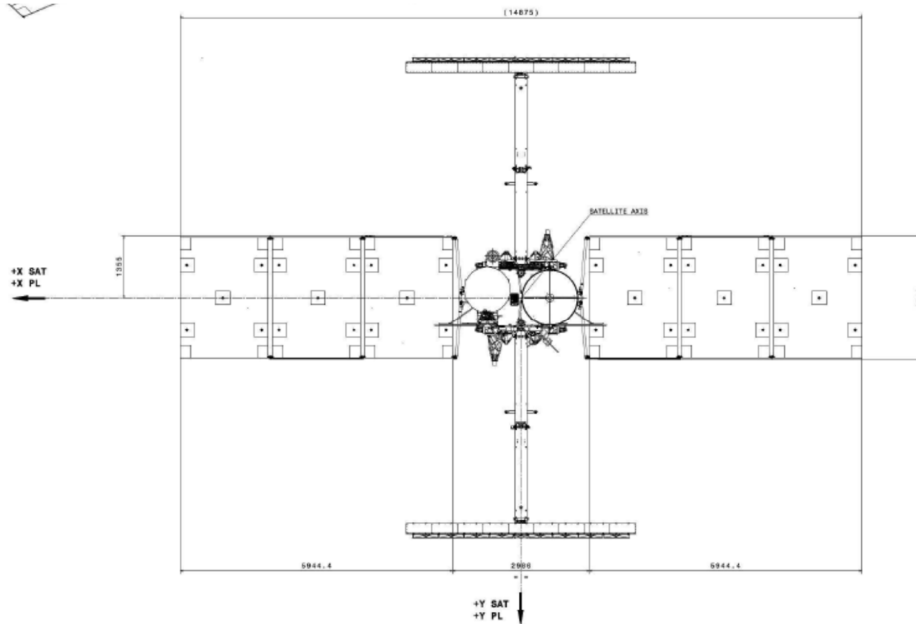


Reference : SWOT-NT-SYS-2191-CNES  
Issue : 1  
Date : 26/10/2023  
Page : 11/47



All information contained in this document are proprietary to CNES and shall be treated as such by the recipient party.

It shall not be used for any purpose other than the use of SWOT and shall not, in whole or in part be reproduced, communicated or copied in any form or by any means (electronically, mechanically, photocopying, recording, or otherwise) to any person without prior written permission from CNES.



**Figure 2-2 Satellite Overview in deployed configuration (source : DR5)**

Axis and dimensions are detailed in the following sections. The main characteristics are:

- Velocity direction is along +/- X vector depending on the yaw flip configuration.
- Each solar array has a surface area of 16.1 m<sup>2</sup>.
- Anti-sun facing radiators are implemented on the KaRIn module to ensure the thermal stability. Surface area is about 5.7 m<sup>2</sup>.

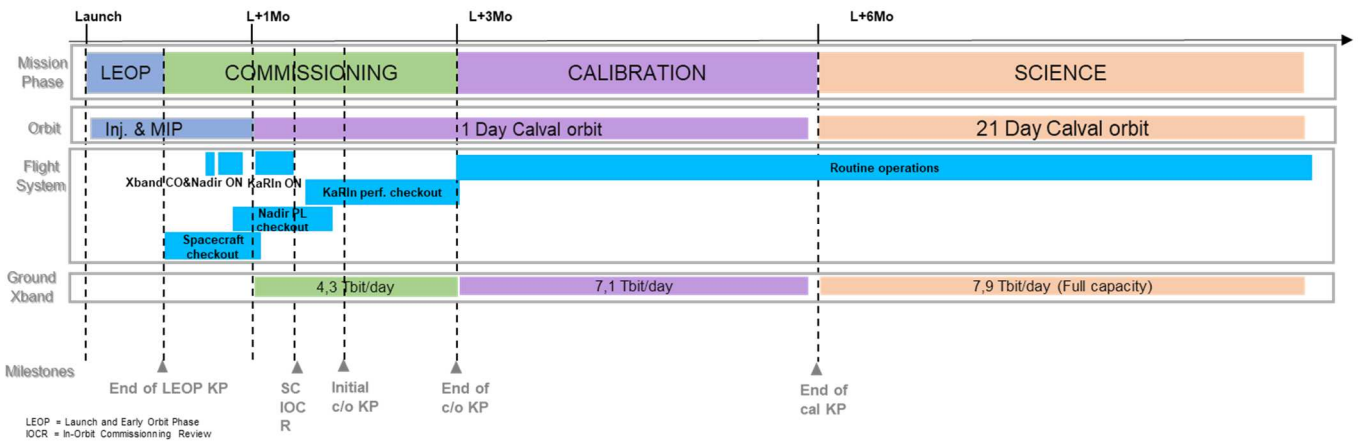
## 2.4. MISSION PHASE AND ORBIT CHARACTERISTICS

### 2.4.1. Mission phases

There are 2 different orbits, one for calibration phase, and one for science phase.

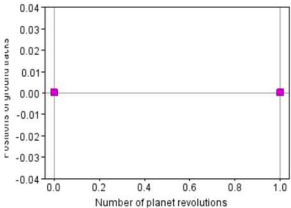
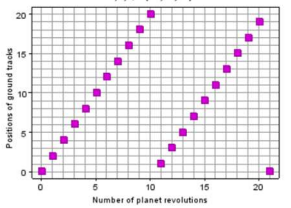
The main mission phases are the following:

- LEOP: Starts after launch, 8 days.
- Acquisition of Fast-repeat orbit
  - DORIS instrument is turned on in checkout phase during Orbit acquisition phase.
- Commissioning and calibration phases (approximately 2x3 months). The orbit during this phase is the Fast-repeat Orbit (1-day repeat cycle).
- Acquisition of science orbit.
- Science phase (3 years at least): The orbit during this phase is the Science Orbit (21-day repeat cycle).
- End of mission, controlled reentry in line with French "LOS" (end of life) requirements.


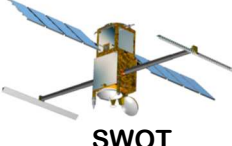


**Figure 2-3 Mission phases**

### 2.4.2. Orbits parameters

	Fast Repeat orbit	Science orbit
Repeat orbit parameters	14 + 0 / 1	13 + 19 / 21
Mean semi-major axis (m)	7235379.8	7268718.9
Altitude (km) (mean sma minus equ. radius)	857	890
Inclination (deg)	77.6	77.6
Mean Eccentricity	0.00105	0.00105
Number of orbits per cycle	14	292
Nodal period (sec)	6131.25	6173.62
Exact repeat cycle duration (days)	0.9934900	20.8645504
Longitude gap between 2 consecutive ground tracks (deg)	25.7142857	25.890
Longitude gap between 2 adjacent ground tracks (deg)	25.7142857	1.2328767
Reference Longitude of the pass1 (deg)	22.4513937	0.1714736
Drift of RAAN local time (minutes/day)	-9.44	-9.35
Duration for 24h RAAN local time change (days)	152.6	154.0
Chronology of ground tracks during the cycle	<p style="text-align: center;">N.P,Q = (14,0,1)</p>  <p style="text-align: center;">No sub-cycle</p>	<p style="text-align: center;">N.P,Q = (13,19,21)</p>  <p style="text-align: center;">Sub-cycle = ~10 days</p>

**Table 2-1 Mean orbit characteristics (from DR1)**

	 <p style="text-align: center;"><b>SWOT</b></p>	Reference : SWOT-NT-SYS-2191-CNES Issue : 1 Date : <b>26/10/2023</b> Page : 14/47
--	---	--

## 2.5. ORBIT MANEUVERS

### 2.5.1. Acquisition of fast-repeat orbit

All the strategy is defined in DR1 and DR2.

The acquisition of the Fast-repeat orbit will take place just after the LEOP phase, after the KaRIn antennas have been fully deployed.

The baseline drift duration is around 7 days.

The general scenario for acquiring the Fast-repeat orbit is the following:

- A first group of maneuvers (semi major axis + inclination) is designed to reach the drift orbit and to correct the main inclination errors. Eccentricity corrections may also be included if needed.
- Once the drift orbit is reached, the ground tracks slowly drift towards the Fast-repeat orbit reference ground tracks. This can take several weeks, depending on the semi-major axis gap between the drift orbit and the Fast-repeat orbit.
- At the end of the drift period, a second series of maneuvers (semi major axis + eccentricity vector) is performed to stop the drift and finely adjust the orbital elements so that the accuracy is compatible with the station keeping window.

The nominal time required to reach the Fast-repeat orbit after launch is around 16 days from start of the orbit acquisition phase.

### 2.5.2. Orbit change (from fast-repeat orbit to science orbit)

The main difference with the Fast-repeat orbit acquisition is the spacing between ground tracks. No long drift period is necessary when changing from the Fast-repeat to the Science orbit, provided the maneuvers are adequately adjusted (in time and amplitude).

The total sequence duration is 7 days.

### 2.5.3. Station keeping

Requirement:

The control window is +/- 1 km on the ground tracks (measured perpendicularly). The control box can be extended to +/- 2.5 km for 10% of the time if necessary in order to meet power limitation constraints. Note that the baseline station keeping design assumes we control the satellite to always comply with the +/- 1km requirement, the +/- 2.5 km flexibility is not expected to be used nominally.

The strategy is described in detail in DR1.

The strategy is to perform:


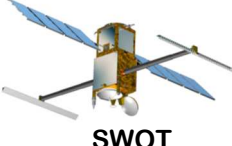
- semi major axis maneuvers to control the ground tracks.
- eccentricity maneuvers to control altitude

The frequency of semi-major axis maneuvers is closely linked to the solar activity, and thus to the year considered in the solar cycle.

Semi-major axis maneuver frequency will be around 1 every 40 days in the years with the highest solar activity (which is the case between 2022 and 2025). Station keeping frequency will be a multiple of 14 days to synchronize these maneuvers with regular KaRIn tables upload, these tables need to be updated after each maneuver.

Post-flight experience: during Checkout and CalVal Phase, the Station Keeping maneuver frequency was 1 every 14 days.



	 <p style="text-align: center;"><b>SWOT</b></p>	Reference : SWOT-NT-SYS-2191-CNES Issue : 1 Date : <b>26/10/2023</b> Page : 15/47
---	---	--

In addition, eccentricity maneuvers are performed about once a year.

For orbit control maneuvers, the thrusters located on the satellite -Z face have to be oriented along velocity or anti-velocity direction. This requires also a dedicated slew around pitch by at maximum + or -90° to maintain the thermal environment of the payload radiator.

The orbit control maneuver duration and sequence is 1954 s + thrust duration, including the following:

- Pre-slew reaction wheel adjustment : 250 s
- Pre-thrust slew (including 120 s stabilization) : 623 s
- Thrust duration : 0.5 to 1.5 s
- Post-thrust slew (including 120 s stabilization) : 1081 s
- Platform stabilization period: 6550 s (duration to ensure nominal level of performance is achieved, driver is Attitude control power spectral density)

### 2.5.4. Calibration maneuvers

Gyro calibration consists of performing 2 cycles of rotations in the 3 axis, with an amplitude of ±30° for roll and yaw and an amplitude of ±22.5° in pitch. These calibrations will be done entirely in eclipses. Gyro calibration maneuvers will be done during check out phase (at least once) and about once per year.

POS-3C calibration attitude maneuvers will be performed in order to estimate precisely some misalignments at instrument level:

This maneuver consists in performing X-axis (Roll) and Y-axis (Pitch) rotations of +/- 0.3°, for typically 3 distinct values of beta angle (2 at least).

300 seconds of stabilized observatory pointing is needed for each maneuver (not including AOCS tranquilization)

Nominally the four successive rotations for one maneuver will be executed in succession: +0.3° in roll, (300 s stabilized), -0.3° in roll, (300 s stabilized), +0.3° in pitch, (300 s stabilized), -0.3° in pitch, (300 s stabilized)

### 2.5.5. Yaw flips

Yaw Flips are performed when the Sun is in the orbital plane.

The SWOT drifting orbit means that the Sun crosses the orbit plane every 2.5 months. To maintain the +Y panel in the shadow, each time the sun vector is crossing the orbital plane by entering in the beta angle range of [-0.5°;+0.5°], the satellite will perform a 180° yaw rotation (called yaw flip) at a specified date sent by a command from ground. It will occur approximately 5 times per year for current orbit definitions.

The X axis (roll) is then oriented in the velocity or anti-velocity direction, depending on Sun aspect angle.

Yaw Flip maneuver duration: 1513 s

### 2.5.6. Timeline for instruments switch-on

0	1	2	3	4	5	6	7	8	9	10	11	12	13	14	15	16	17	18	19	20	21	22	23	24	25	26	27	28	29	30	31	32	33	34	35	36	37
12/15	12/16	12/17	12/18	12/19	12/20	12/21	12/22	12/23	12/24	12/25	12/26	12/27	12/28	12/29	12/30	12/31	1/1	1/2	1/3	1/4	1/5	1/6	1/7	1/8	1/9	1/10	1/11	1/12	1/13	1/14	1/15	1/16	1/17	1/18	1/19	1/20	1/21
LEOP									CHRISTMAS BREAK									SSR		Xband		YF#1		NADIR TURN ON				KaRin Turn ON : 6 days									


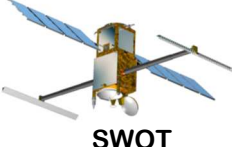
**Figure 2-4 Summarized 1<sup>st</sup> month calendar timeline (version Launch – 13 days)**

All information contained in this document are proprietary to CNES and shall be treated as such by the recipient party.

It shall not be used for any purpose other than the use of SWOT and shall not, in whole or in part be reproduced, communicated or copied in any form or by any means (electronically, mechanically, photocopying, recording, or otherwise) to any person without prior written permission from CNES..

Days since Launch	22	23	24	25	26	27	28	29	30	31	32	33	34	35	36	37
calendar date - Launch = Dec. 15th	1/6	1/7	1/8	1/9	1/10	1/11	1/12	1/13	1/14	1/15	1/16	1/17	1/18	1/19	1/20	1/21
<b>Nadir PL Turn On</b>																
X-band chain check out																
X-Band Turn On																
X-band checkout (single string and dual string)																
Nadir PL Turn On																
Doris Turn On																
Nadir Altimeter Turn ON Initial Turn ON)																
Radiometer Turn On																
GPSP Turn On																

**Figure 2-5 Detailed PL Turn ON**

	 <p style="text-align: center;"><b>SWOT</b></p>	Reference : SWOT-NT-SYS-2191-CNES Issue : 1 Date : <b>26/10/2023</b> Page : 17/47
--	---	--

### 3. SATELLITE DESCRIPTION

#### 3.1. SATELLITE REFERENCE FRAME

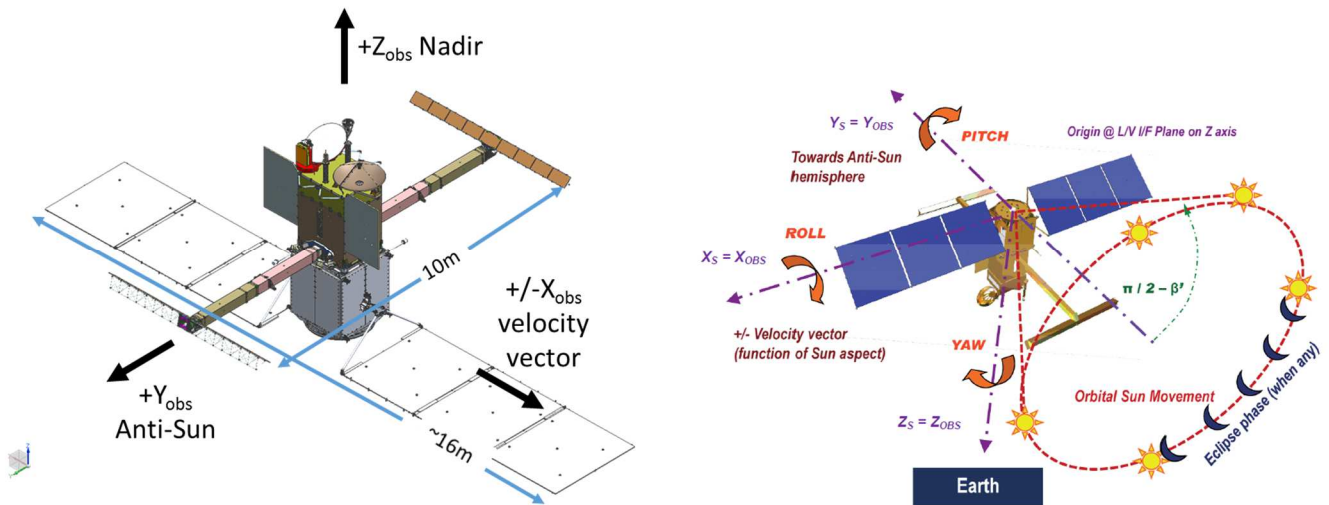
The coordinate system (X,Y,Z) is described in the previous figure and below:

- Z-axis is pointed at the local geodetic nadir.
- X-axis is orthogonal to the Z-axis and in the plane defined by the observatory orbital velocity vector and the Z-axis.
- Y-axis completes the 3rd orthogonal axis and is oriented opposite to Sun to provide a cold face for the KaRIn radiator.

The Observatory Reference frame is defined by :

- its origin  $O_{OBS}$  at the center of the launcher interface ring at launch vehicle separation plane level.
- $(-Z_{OBS})$  axis perpendicular to the launcher interface in the direction to the launcher.
- $(+Y_{OBS})$  axis perpendicular to the face occupied by the radiator on the payload.
- $(+X_{OBS})$  axis completing the triebre and parallel to the solar array rotation axes.

The Satellite reference frame is identical to the Observatory Reference Frame.



**Figure 3-1 Satellite axes**

We have chosen a common reference frame to be used for POD references.

The PL reference frame is to be considered for the POD reference frame.

The PL ref frame is actually the KaRIn Metering Structure Frame. This frame is described below; it is positioned on KaRIn Metering Structure, which supports the KaRIn antennas, and is the PL reference frame for alignments, as everything on the payload will be aligned to this frame. KMSF is basically aligned with SC reference frame with a translation in Z.

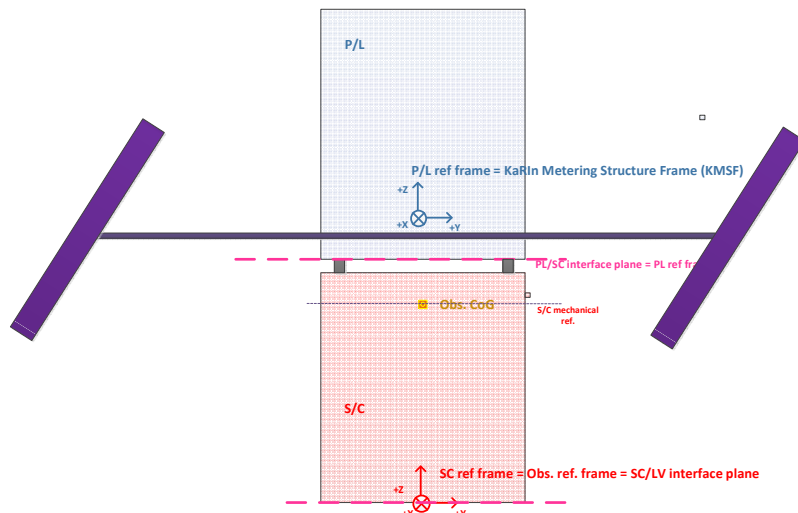


Figure 3-2 SC and PL reference frames

## 3.2. MASS PROPERTIES

### 3.2.1. Initial mass

Satellite mass = 2107 kg (best estimates correlated with mass properties results; Beginning of Life)

The detail is provided in the Table below.

Component	mass
PF without SA (Gaz included)	790,00
Solar Array : +X wing	66,50
Solar Array: -X wing	66,50
Propellant	358,03
Payload with DAA	826,00
SAT Dry mass (without SA and without propellant)	1616,00
Satellite total mass	2107,03

Table 3-1: Satellite initial mass, details


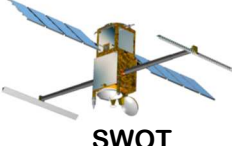
### 3.2.2. In flight initial mass

TAS propellant mass measurement before flight is very precise : 358.03 kg

Once in flight, the operational mass estimation method at FDS is based on PVT method.

The pressure sensor accuracy, especially for its first measurements, is 8.5 kg worst case.

Note: Using the Pulse counting method (processing of the precise time-history of the thruster activation profile) to estimate the mass consumption in flight would decrease the uncertainty to 3.4 kg at end of science mission (with no

	 <p style="text-align: center;"><b>SWOT</b></p>	Reference : SWOT-NT-SYS-2191-CNES Issue : 1 Date : <b>26/10/2023</b> Page : 19/47
--	---	--

margin). However, Center of mass preflight budgets are compliant with both methods.

Static initial propellant mass bias estimation: first in flight PVT measurement gave the bias estimation, as ground measurement was very accurate:

- Initial propellant mass bias : -5.35 kg
- This gives an initial bias in Z of +2.75 mm

This bias correction was implemented in Mission Orbit computation (CNES mission center) from June 18<sup>th</sup> 2023: this component applies a bias on satellite mass of +5.35 kg and on satellite CoG in Z of -2.75 mm -> this is consequently transparent for users who get the best possible estimate.

A few key values :

Initial mass : 2107 kg – AIT final measurements

Initial mass after 1 day orbit acquisition : 2102.2 kg – SAT-COM value with delta mass correction

Initial mass after orbit change, start on 21 day orbit : 2085.8 kg – SAT-COM value with delta mass correction

### 3.3. SATELLITE CENTER OF MASS COORDINATES

The detailed analysis for CoG uncertainties analysis can be found in DR5 and DR14.

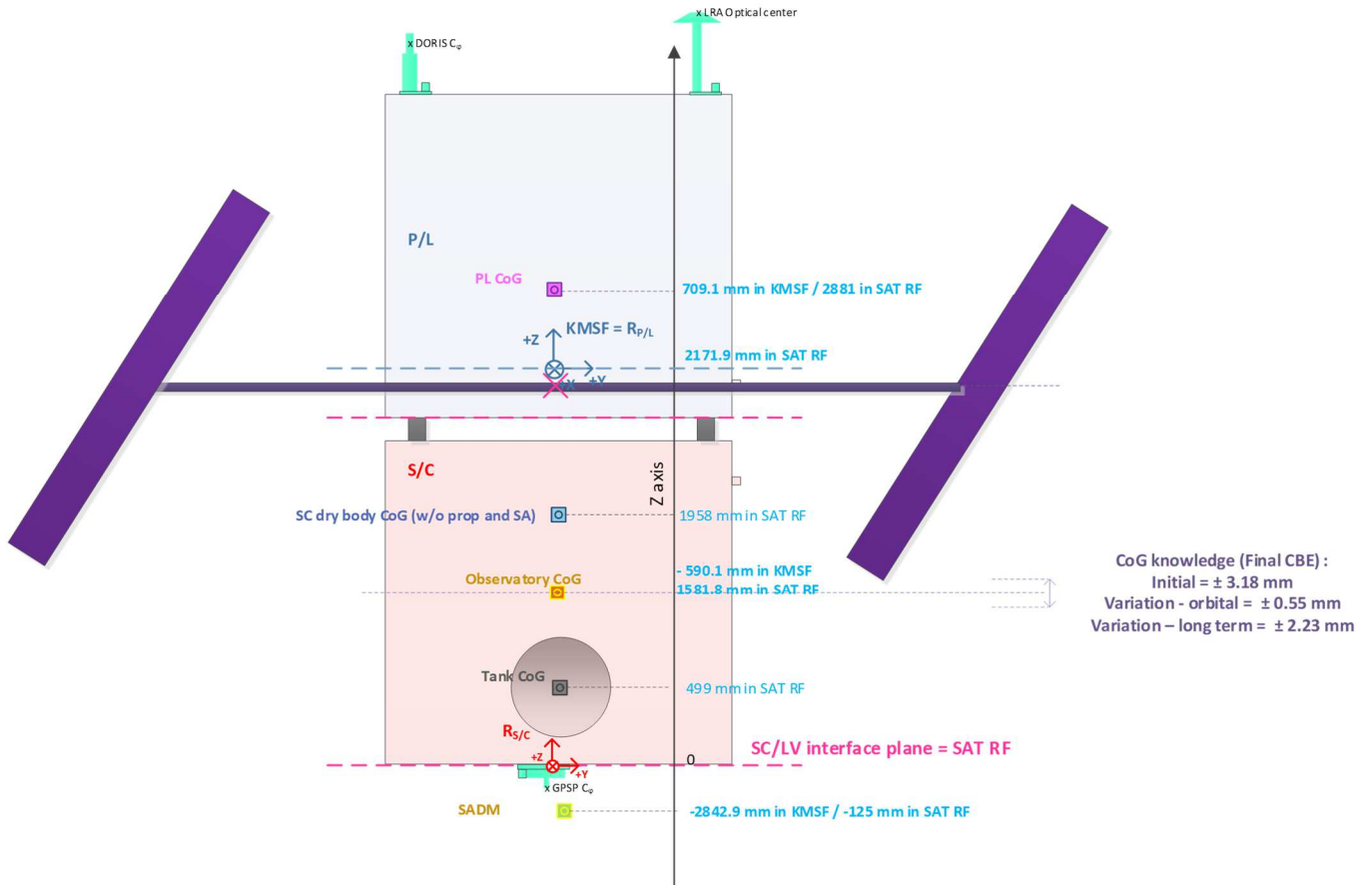
#### 3.3.1. Initial in flight satellite CoG

##### 3.3.1.1. Individual level

The initial CoG per elements and for the satellite are given in the Table below.

	Mass	X en mm	Y en mm	Z en mm
<b>PF without SA ( including gaz)</b>	790,00	-7,00	14,00	993,00
<b>SA : +X wing (SADM angle = 0°)</b>	66,50	3747,40	-3,90	-131,60
<b>SA: -X wing (SADM angle = 0°)</b>	66,50	-3731,20	-3,30	-119,30
<b>Propellant ( 358,03 is the DB value)</b>	358,03	0,00	0,00	499,00
<b>PL with DAA</b>	826,00	7,00	8,00	2881,00
<b>SAT in OBS reference frame</b>	2107,00	6,20	8,60	1579,00
<b>SAT without SA</b>	1974,00	0,13	8,95	1693,43
<b>SAT without SA without propellant</b>	1615,97	0,16	10,93	1958,07
<b>SAT with SA in SAT reference frame</b>	2107,03	0,63	8,16	1578,60
<b>SAT with SA in KMSF</b>	2107,03	1,83	8,00	-593,40

**Table 3-2 Sublevel and satellite mass and CoG values in Satellite reference frame**



**Figure 3-3 Initial satellite mass and centering assumptions**

### 3.3.1.2. Initial satellite CoG after launch

The Table below summarizes the initial Center of Mass coordinates in flight, before any maneuver, and after all deployments are done.

CoG coordinates	SADM angle = 0°		SADM angle = 12°		SADM angle = 30°	
	<i>in SAT RF</i>	<i>in KMSF</i>	<i>in SAT RF</i>	<i>in KMSF</i>	<i>in SAT RF</i>	<i>in KMSF</i>
X	0.6 mm	1.8 mm	0.6 mm	1.8 mm	0.6 mm	1.8 mm
Y	8.2 mm	8 mm	-6.4 mm	-4.5 mm	-22 mm	-22.1 mm
Z	1578.6 mm	-593.4 mm	1580 mm	-592 mm	1586.8 mm	-585.2 mm

**Table 3-3 Initial Center of Mass positions in KMSF and SAT reference frame**


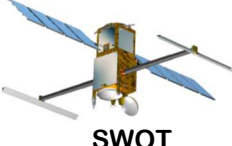
### 3.3.1.3. Satellite CoG after orbit change

As described in mission phases section, the SWOT satellite will fly on 2 orbits : 1-day orbit after injection errors corrections during checkout and calval, and 21-day orbit at the end of calval. The science phase starts once the 21-day orbit is acquired.

The estimation of the satellite CoG at the beginning of science phase is the following. This also includes the – 5.3 kg mass initial mass.

All information contained in this document are proprietary to CNES and shall be treated as such by the recipient party.

It shall not be used for any purpose other than the use of SWOT and shall not, in whole or in part be reproduced, communicated or copied in any form or by any means (electronically, mechanically, photocopying, recording, or otherwise) to any person without prior written permission from CNES.

	 <p style="text-align: center;"><b>SWOT</b></p>	Reference : SWOT-NT-SYS-2191-CNES Issue : 1 Date : <b>26/10/2023</b> Page : 21/47
--	---	--

Satellite center of mass in mm	X	Y	Z	X	Y	Z
	In KMSF			In SAT RF		
SA angle 0°	1,84	8,08	-583,22	0,64	8,24	1588,78
SA angle 12°	1,84	-4,57	-581,84	0,64	-4,41	1590,16
SA angle 30°	1,84	-22,32	-574,95	0,64	-22,16	1597,05

**Table 3-4 Center of Mass positions in KMSF and SAT reference frame at the beginning of Science Phase**

Note : These are the theoretical values, which are expected to be close to the SAT\_COM ones but not exactly the same as

- After each maneuver, there is an update with some uncertainty, mostly in Z due to propellant mass estimation
- The operational calculation is slightly different operationally than what I did

### 3.3.1.4. Inputs for Doris ZQS file

For onboard Diode processing, Doris needs some information on the satellite mass and center of mass position. This is contained in so named ZQS file.

#### Inputs for ZQS\_0503 (Calval 1 day orbit)

COM in SAT	X = 0,001 m	Y = 0,023 m	Z = 1,580 m
MASS	2097 kg		

**Table 3-5 Doris ZQS\_0503 inputs**

#### Inputs for ZQS en m ZQS\_0504 & ZQS\_0505 (Science 21 days orbit)

Defined before orbit change realization, based on Maneuvers strategy prediction, and actually very close to the reality (-16 kg)

COM in SAT	X = 0,001 m	Y = -0,006 m	Z = 1,592 m
Mass	2086 kg		

**Table 3-6 Doris ZQS\_0504 and ZQS\_0505 inputs**

## 3.3.2. In flight modeled variations

There are some expected variations of the satellite center of mass on orbit.


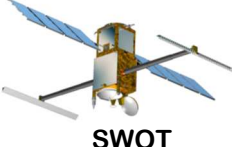
### 3.3.2.1. Ergol consumption

As on other missions ergol consumptions for maneuvers will induce slight changes.

However, SWOT must be able to perform a controlled reentry at the end of its life, which means a high quantity of ergols must be embarked, with a very small percentage used during the mission.

Satellite assumptions are given in Table 3-7.

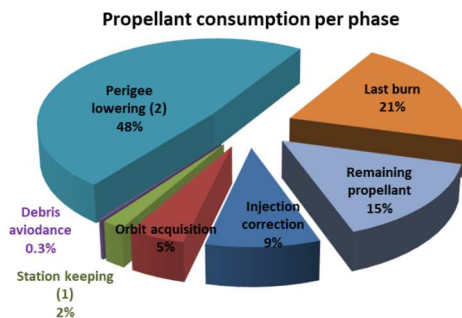
Several points can be pointed out:

	 <p style="text-align: center;"><b>SWOT</b></p>	Reference : SWOT-NT-SYS-2191-CNES Issue : 1 Date : <b>26/10/2023</b> Page : 22/47
--	---	--

- A first calibration phase will be done during about the first month after KaRIn deployment (on calval orbit)
- The orbit change will have an impact on this calibration and a second calibration is expected once on the science orbit
- Once on the science orbit, the cumulated consumption will be lower than 7 kg over 5 years. The impact on CoM variation will be less than 1 mm / year
- A specific product will be produced to give the cumulated evolution of satellite mass and CoM over life.

Large Velocity impulse budget (320m/s) dominated by re-entry needs

- Including all margin and additional 5% required on EOL maneuvers
- Propellant budget shows a positive extra - margin of 48 kg (13%)



Delta V budget	Origin	Budget per phase [m/s]
Injection errors & orbit acquisition	SWOT-SAT-REQ-0770	33.2
Orbit change	SWOT-SAT-REQ-0770	16.8
Station keeping (5years)	SWOT-SAT-REQ-0770 & SWOT-SAT-REQ-2260	6.7
Debris avoidance (5years)	SWOT-SAT-REQ-2260	1
EOL - Perigee Lowering	Output of Mission Analysis	179
EOL - Last maneuver allocation	Output of Mission Analysis	73
Additional robustness margin on EOL maneuvers (5%)	System margin	12
<b>Total Velocity Impulse Budget</b>		<b>322</b>

**Table 3-7**

**Satellite assumptions for ergol budget (preflight)**

Post-flight update :

- Orbit acquisition (injection error) : 5.3 m/s and 5.2 kg
- Orbit change : 17 m/s, 16 kg

### 3.3.2.2. Solar array rotations

Solar array angle adjustments will be planned typically 4 times every 78 days: when beta angle is -25° / -6° / +6° / +25°, with +/- 2° tolerance on beta angle value. This leads to 18 rotations per year.

This tolerance, which represents around 2 days, will enable the ground to choose when scheduling the rotation adjustment, accounting for all other constraints.

This is illustrated in the figure below:

- SA have to be moved from 30° to 12°: as soon as Beta angle is higher than -25°,
- SA have to be moved from 12° to 0° : as soon as Beta angle is higher than to -6°,
- SA have to be moved from 0° to 12° : as soon as Beta angle is higher than 6°,
- SA have to be moved from 12° to 30° : as soon as Beta angle is higher than 25°.



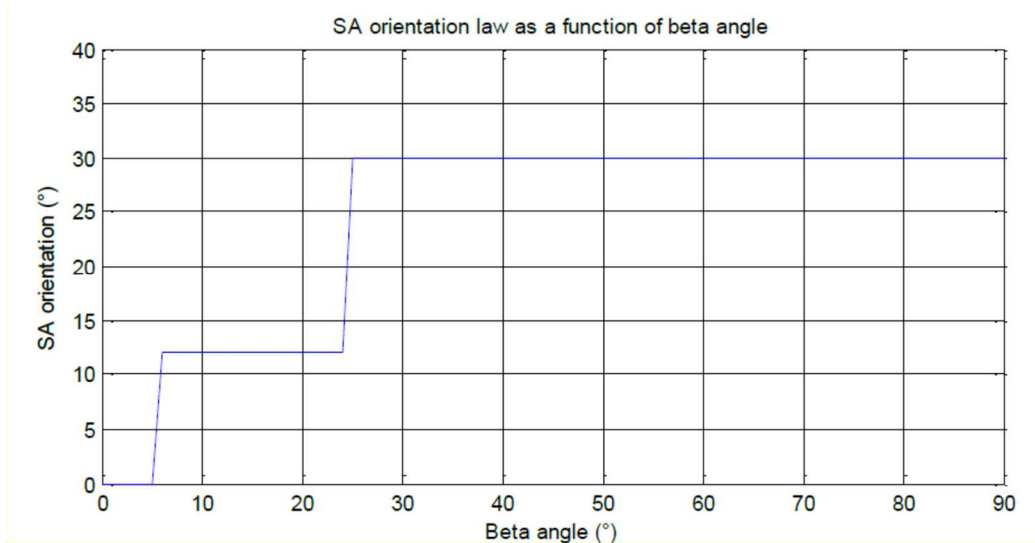


Figure 3-4 SA command orientation as a function of beta angle

Solar array angle value is part of HKTM\_PARAM interface content and is used by mission centers for MOE processing or any other ephemeris processing.

Theoretical evolutions of solar array CoM are given by  $Y(\alpha)=Z_0 \sin\alpha$  and  $Z(\alpha)=Z_0 \cos\alpha$

Where  $\alpha$  is the angle of rotation (between 0 and 55°), and  $Z_0$  is the SA CoM position when at 0°

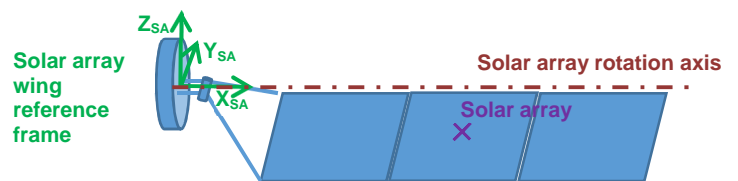
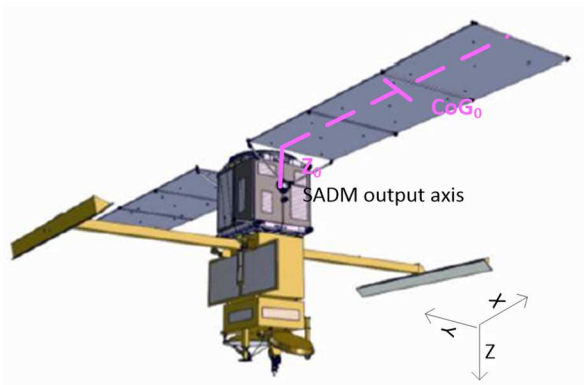
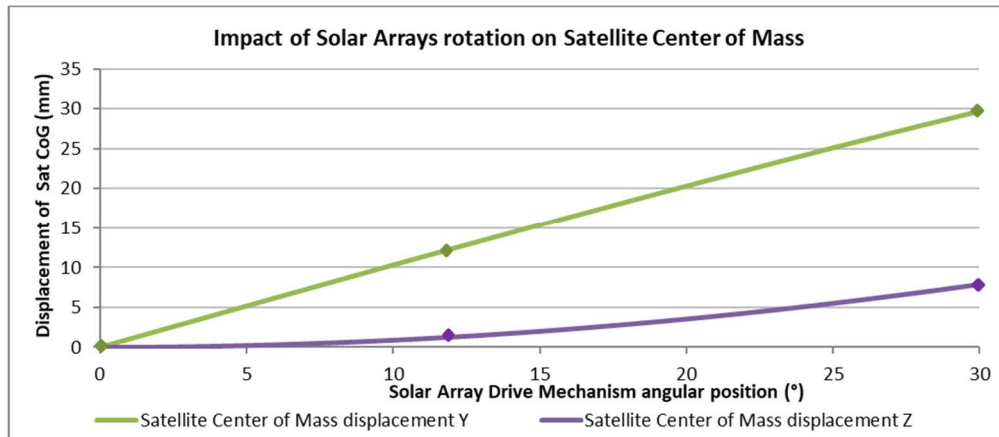


Figure 3-5 Effect of SA variation on SA CoM position

Solar Array wings Center of mass is not aligned with its rotation axis. As a consequence, the angular position of the wings has a strong impact on the satellite center of mass position, which needs to be modeled in order to avoid satellite center of mass position knowledge error of 30 mm.



**Figure 3-6 Solar array CoM expected variations wrt solar array angle, in Y and Z axes**

In addition to the basic geometrical rotation of a perfect wing around a perfectly oriented SADM axis, with a perfect initial “0°” position, the following effects are measured to refine the solar arrays center of mass position knowledge :

- The solar array mass and center of mass position after wing deployment to precisely represent the geometry of the rotating part
- The SADM position and orientation in satellite reference frame to precisely know the rotation axis
- The SADM axis orientation for the initial “0°” position (the canonical position), after deployment, to precisely know the reference point (estimated in checkout phase)

Detailed combination of the matrices is given in DR14.

The implementation of the values gives the following values for Solar Array wings center of mass position in SAT reference frame:


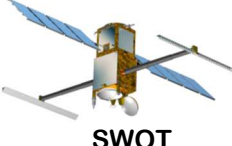
CoG Wings in SAT RF	X in mm	Y in mm	Z in mm
SADM rotation = 0			
SA : +X wing	3747,40	-3,90	-131,60
SA: -X wing	-3731,20	-3,30	-119,30
SADM rotation = 12			
SA : +X wing	3747,40	-203,60	-109,80
SA: -X wing	-3731,20	-200,50	-97,90
SADM rotation = 30			
SA : +X wing	3747,40	-483,90	-0,90
SA: -X wing	-3731,20	-477,40	9,50

**Table 3-8 Solar array wings center of mass position in satellite reference frame as a function of SADM angle**

### 3.3.3. In flight knowledge

Three kinds of frequencies have been defined for all the uncertainties affecting the knowledge of the vector between POD instrument reference (center of phase) and the actual CoM of the satellite (see):

- Static or initial knowledge errors refers to errors at the beginning of on-orbit operations, so it contains all the

	 <p style="text-align: center;"><b>SWOT</b></p>	Reference : SWOT-NT-SYS-2191-CNES Issue : 1 Date : <b>26/10/2023</b> Page : 25/47
---	---	--

uncertainties before that state (measurements uncertainties, modelling errors, 0g, deployment of KaRIn antennas); these components can be mainly adjusted through the first months of processing. Several diagnoses are used to evaluate POD accuracy: high elevation SLR residuals, SSH residuals at crossover points, intercomparison of different orbit solutions, orbit overlap. The vector from the satellite CoM to the DORIS or GPS phase center can actually be estimated as part of the POD process and these methods can allow to identify potential errors on these vectors, or mis-modeling, e.g. GPS antenna phase variations (due, for example, to multipath). This will be done during the beginning of SWOT calval phase and will thus allow to adjust for the static components of the knowledge errors. Most part of these static errors are related to mechanical or initial thermal conditions and will be the same for both calval and science orbits. However, a new calval is planned for POD at the beginning of science phase.

- Orbital variations refer to all the unknown variations along the orbit (typically thermoelastic effects);
- Long term variations refer to all the unknown variations occurring with a period higher than 10 days (Examples: maneuvers (propellant consumption), thermoelastic induced by beta angle...). Part of it is predictable, for instance propellant consumption impact on satellite CoM position is estimated

The satellite CoM knowledge allocations are:

	X/Y/Z axis		
	static	<b>Orbital variations</b>	Long term variations
CoM position knowledge	± 6 mm	<b>± 1.5 mm</b>	± 4 mm

### 3.4. ATTITUDE ERRORS REQUIREMENTS

Requirement (Flight System level)	Req at 1σ	Req at 3σ
Pointing control (absolute): roll and yaw	roll control : < 0.066 °(1σ)	roll control : < 0.2 °(3σ)
Pointing control (absolute): pitch	pitch control : < 0.033 °(1σ)	pitch control : < 0.1 °(3σ)
Pointing knowledge: roll and yaw	roll knowledge : < 0.01 °(1σ)	roll knowledge : < 0.03 °(3σ)
Pitch knowledge	pitch knowledge : < 0.02 °(1σ)	pitch knowledge : < 0.06 °(3σ)
Pointing knowledge after ground processing	For $f > 5.2e-4$ Hz, then $RattFine(f) = 4.1035e-06 f^{(-2)}$ asec <sup>2</sup> / Hz  RMS < 6.6 asec (1σ), includes 1 asec for STR mounting interface variability (4.6 asec = 1.9 mdeg)	

**Table 3-9 Attitude errors requirements**

### 3.5. MECHANICAL DISTURBANCES

#### 3.5.1. Solar array rotation

Some duration of unavailability is associated with the rotation, as nominal stability and pointing performances cannot be met when these events occur.

Duration of the associated disturbance : 100s for the rotation itself, followed by 670s for stabilization (with no additional thermal stabilization for KaRIn instrument).

All information contained in this document are proprietary to CNES and shall be treated as such by the recipient party.

It shall not be used for any purpose other than the use of SWOT and shall not, in whole or in part be reproduced, communicated or copied in any form or by any means (electronically, mechanically, photocopying, recording, or otherwise) to any person without prior written permission from CNES...

### 3.5.2. Thermal snap

Thermal snap is the thermoelastic effect due to sudden illumination change on the satellite large solar arrays at eclipse entry / exit. Early identification led to allocate 120s unavailability for eclipse transients during the eclipse season. This results in a 3.5% of mission data a-priori unavailability.

## 3.6. SATELLITE SURFACES

*Surface properties in the visible (ultra-violet) spectrum*

Surface	+X	-X	+Y	-Y	+Z	-Z	SA (cells)	SA (rear)
<b>Area (m<sup>2</sup>)</b>	7.6	7.6	11.1	10.9	6.1	4.7	16.1 (each wing)	16.1 (each wing)
<b>Specular Reflectivity</b>	0.51	0.48	0.69	0.42	0.53	0.48	0.17	0
<b>Diffuse Reflectivity</b>	0.15	0.18	0.01	0.18	0.20	0.14	0	0.45
<b>Absorptivity (α)</b>	0.34	0.34	0.30	0.40	0.27	0.38	0.83	0.55

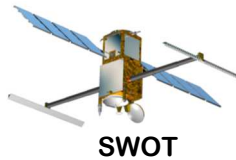
*Surface properties in the infrared spectrum (TBC)*

Surface	+X	-X	+Y	-Y	+Z	-Z	SA (cells)	SA (rear)
<b>Area (m<sup>2</sup>)</b>	7.6	7.6	11.1	10.9	6.1	4.7	16.1 (each wing)	16.1 (each wing)
<b>Specular Reflectivity</b>	0.51	0.48	0.69	0.42	0.53	0.48	0.17	0
<b>Diffuse Reflectivity</b>	0.15	0.18	0.01	0.18	0.20	0.14	0	0.45
<b>Emissivity (α)</b>	0.34	0.34	0.30	0.40	0.27	0.38	0.83	0.55

**Table 3-10 Satellite surface and properties (same as in DR9)**

Note : The presented values are the same in infrared and visible spectrum as only one set of surface properties are available in the spacecraft documentation (PDR).

These values are important for the solar pressure model, and shall be established as global values for each surface, taking into account the different properties of the different materials, and their respective contributions to the global coefficient.



Reference : SWOT-NT-SYS-2191-CNES  
 Issue : 1  
 Date : 26/10/2023  
 Page : 27/47

		Temp (°C) <sup>(*)</sup>							
		Solar Abs.		IR emittance		Non-Op Mode		Operat. Mode	
		BOL	EOL	BOL	EOL	Min	Max	Min	Max
P/L radiators	PLM KaRIn +Y	0.2	0.31	0.9	0.9	-105	60	-40	60
	PLM Nadir +Y	0.2	0.31	0.9	0.9	-90	60	-40	60
	PLM Nadir +X	0.14	0.25	0.85	0.85	-90	60	-40	60
	PLM Nadir -X	0.14	0.25	0.85	0.85	-90	60	-40	60
	<u>PLM Nadir -Y</u>	<u>0.14</u>	<u>0.25</u>	<u>0.85</u>	<u>0.85</u>	<u>-90</u>	<u>60</u>	<u>-40</u>	<u>60</u>
P/L MLI blankets		0.38	0.5	0.68	0.64	NA	NA	NA	NA
Payload Module Structure <sup>(*)2</sup>		NA	NA	NA	NA	-90	60	-40	60
KaRIn Reflector	KaRIn Reflector -Y	0.27	0.46	0.67	0.66	-110	95	-65	95
	KaRIn Reflector +Y	0.27	0.46	0.67	0.66	-110	95	-65	95

(\*1) Mean Surface External Side Temperature - Orbital average

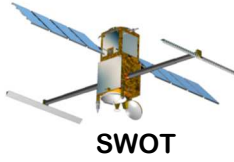
(\*2) Temperature of structure underneath MLI (ROM) - TAS to compute MLI temperature

**Table 3-11 Surface thermal properties**

Post flight note : as POD performances are already proven this section is not updated versus previous options, except for SA wings surface.

### 3.7. SATELLITE EXTERNAL GEOMETRY

The dimensions are the following:



Reference : SWOT-NT-SYS-2191-CNES  
Issue : 1  
Date : 26/10/2023  
Page : 28/47

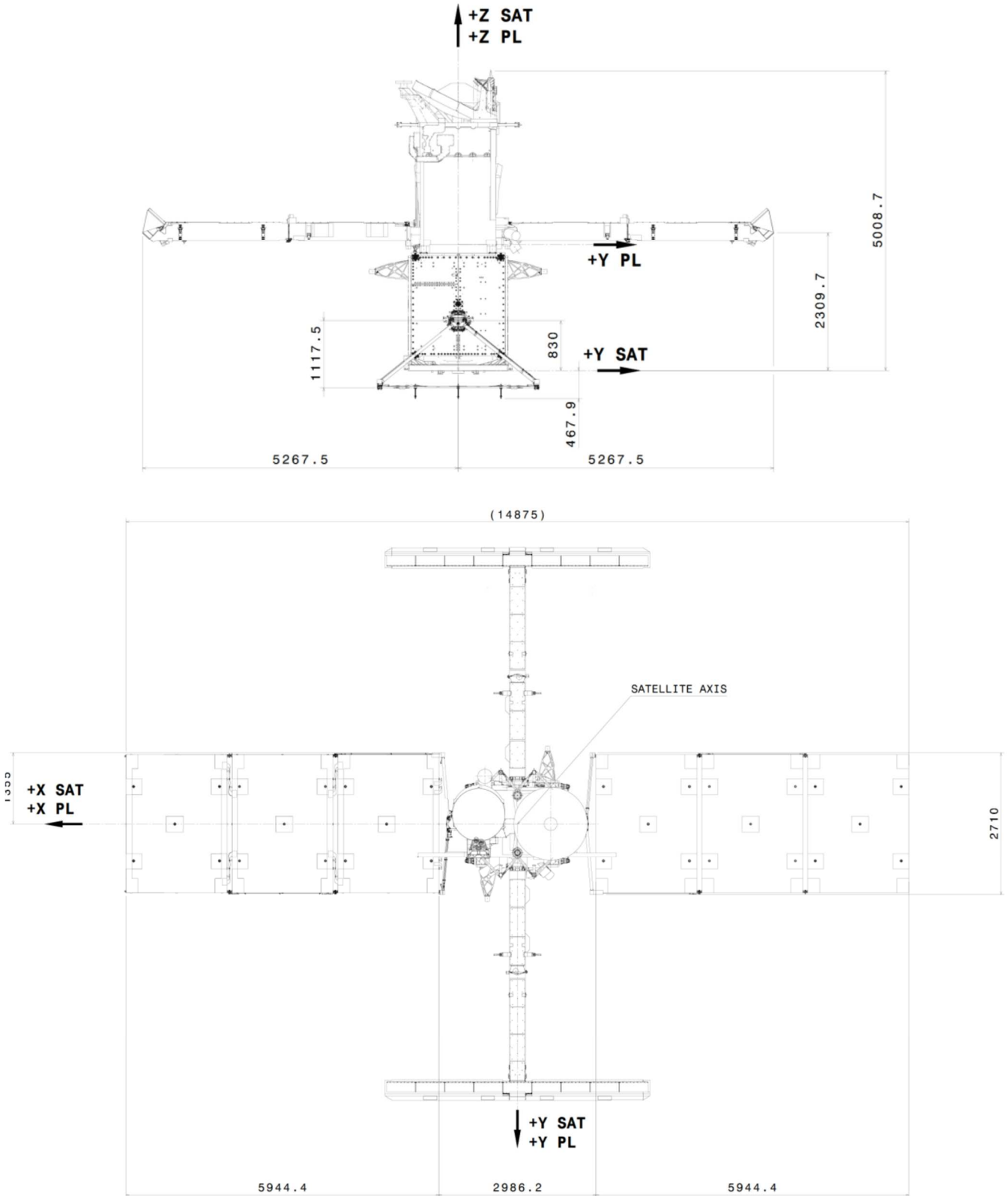

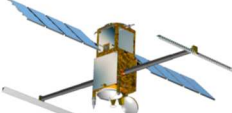


Figure 3-7 Overall dimensions of the SWOT Satellite in deployed configuration (SQR)

	 <p style="text-align: center;"><b>SWOT</b></p>	Reference : SWOT-NT-SYS-2191-CNES Issue : 1 Date : <b>26/10/2023</b> Page : 29/47
--	---	--

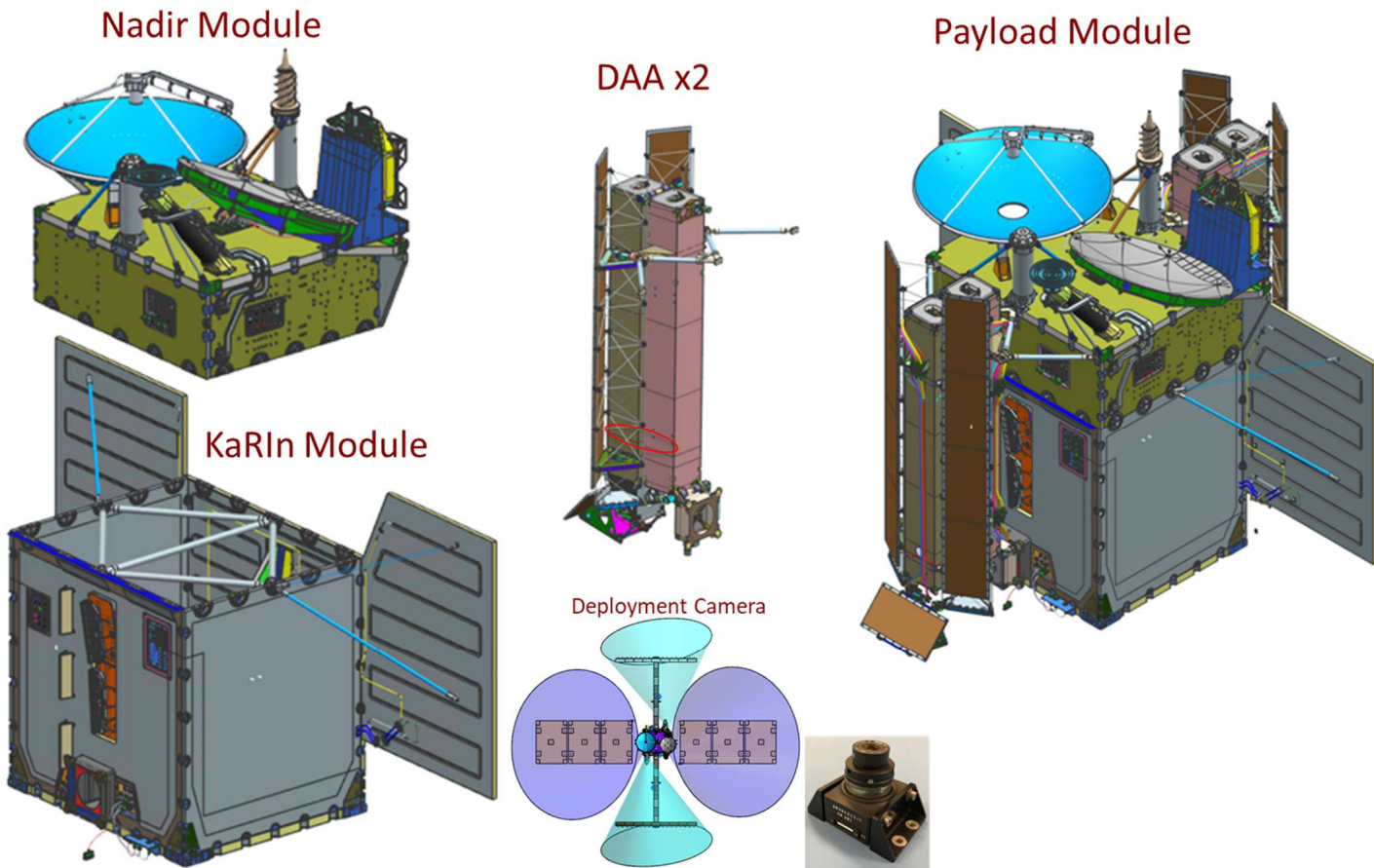
The satellite is more than 5 meters high, with large solar arrays and a span of 15 m.

Two Solar Panel Wings are accommodated on the +/- X-sat sides of the platform.

The surface of each solar array is 16.1 m<sup>2</sup>

The payload module is about 3 m high. It is composed of KaRIn module and Nadir module.

Anti-sun facing radiators are implemented on KaRIn module to ensure the thermal stability. Surface is about 5.7 m<sup>2</sup>.



**Figure 3-8 Payload module components (© SIR Review Presentation)**

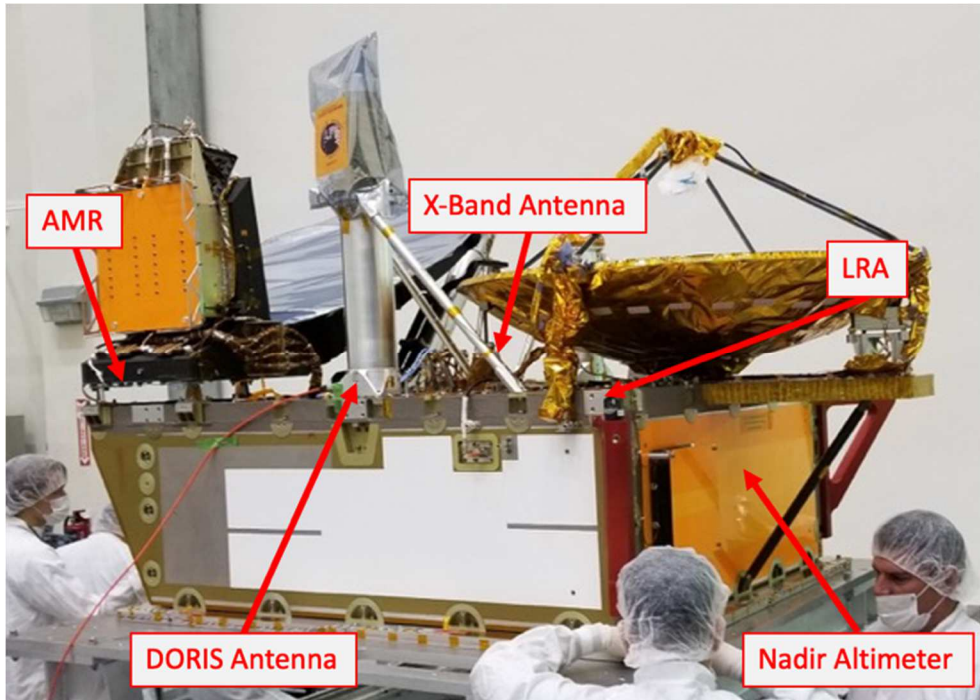


Figure 3-9 Nadir Payload module

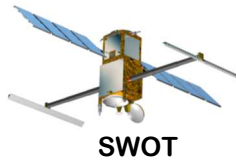


Figure 3-10 Payload module in AIT





**Figure 3-11 Satellite in AIT**



### 3.8. THERMAL FLUX ASSUMPTIONS

The following tables gives the thermal environment hypothesis for the different worst cases (Hot, Cold and Energetic).  
 The worst cases are different for the platform (+/- X panels, +/- Y panels, Reaction Wheels and Propulsion Zone) and for the star-tracker optical heads.

		Thermal WC Hot Radiator Sizing		Thermal WC COLD Heaters Sizing	Thermal COLD Case in EPS WC Heating Power in EPS WC
Calibration / Validation Operating Mode	Case Label	T01 & T02	T03	N.A. in CAL/VAL Mode	N.A. in CAL/VAL Mode
	Altitude [km]	857			
	Beta [°]	0	62		
	Pointing	+Z Nadir			
	Speed Vector	+/- X			
	Solar Array Angle [°]	0	-60		
	Solar Flux [W/m <sup>2</sup> ]	1418 (WS)			
	Earth IR Flux [W/m <sup>2</sup> ]	Calculated by Ethern (WS)			
	Albedo Flux [W/m <sup>2</sup> ]	Calculated by Ethern (WS)			
Thermo-Optic	BOL				
Science Operating Mode	Case Label	T12 & T13	T14	T10	E10 & E11
	Altitude [km]	891		891	891
	Beta [°]	0	62	90	0
	Pointing	+Z Nadir		+Z Nadir	+Z Nadir
	Speed Vector	+/- X		+/- X	+/- X
	Solar Array Angle [°]	0	-60	-30	0
	Solar Flux [W/m <sup>2</sup> ]	1418 (WS)		1326 (SS)	1326
	Earth IR Flux [W/m <sup>2</sup> ]	230,5 (WS)		215,54 (SS)	215,54
	Albedo Flux [W/m <sup>2</sup> ]	496,3 (WS)		464,1 (SS)	464,1
Thermo-Optic	EOL		BOL	BOL	

## 4. INSTRUMENTS PARAMETERS USED FOR POD PROCESSING

### 4.1. SATELLITE AND KMSF REFERENCE FRAMES RELATION

Measurements during final test in Observatory AIT

<b>AIT Phase</b>	<b>SAT FFT</b>
<b>Date</b>	<b>22/08/2022</b>
<b>TR</b>	<b>TR00436</b>

	<b>XKMSF</b>	<b>YKMSF</b>	<b>ZKMSF</b>
<b>OBS Origin (mm)</b>	1,167	-0,162	-2171,861

<b>Rotation</b>	<b>XKMSF</b>	<b>YKMSF</b>	<b>ZKMSF</b>
<b>XSAT</b>	0,999999945123	-0,000123537572	-0,000307394991
<b>YSAT</b>	0,000123629867	0,999999947283	0,000300249117
<b>ZSAT</b>	0,000307357883	-0,000300287103	0,999999907679
<b>Euler ZYX (°)</b>	-0,017	-0,018	0,0071

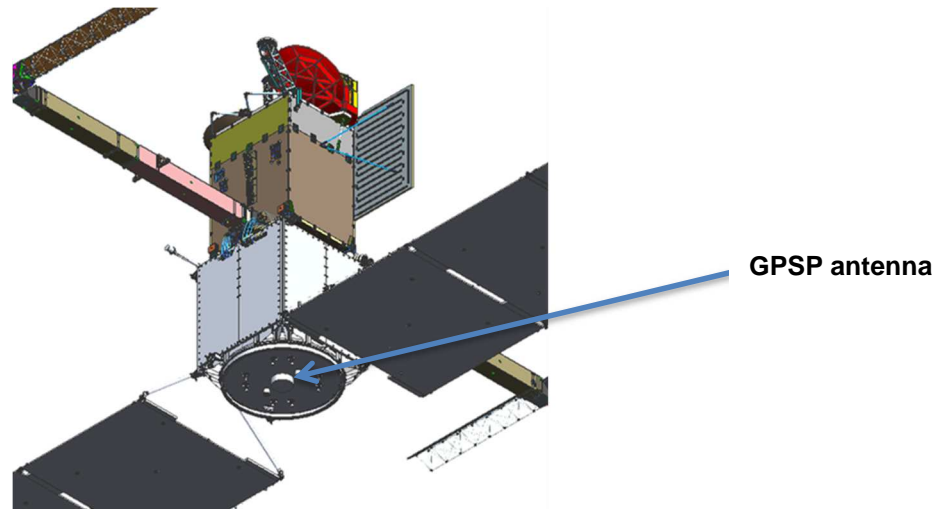
*Rotation matrix convention: Direct, orthogonal, orthonormal*

SAT Axis = OBS Axis

**Table 4-1 KMSF reference frame in satellite reference frame**

### 4.2. POD INSTRUMENT ANTENNAS LOCATION

Doris and LRA are mounted on the payload nadir module (see Figure 3-8), whereas GPSP is mounted on the spacecraft module.



**Figure 4-1 GPSP accommodation**

LRA is mounted on a pedestal that is 646 mm high. Doris is mounted on a pedestal that is 518 mm high.  
DORIS antenna RF axis is parallel to the +Z satellite axis and is nominally nadir pointed.  
GPSP antenna RF axis is pointed toward the -Z axis.

## 4.3. DORIS PARAMETERS

### 4.3.1. Doris antenna phase center

Following table gives the position of the mechanical antenna reference frame in KMSF, and the position of the antenna phase center in this antenna ref frame.

The reference point for Doris (i.e. origin of the antenna reference frame) is defined by the intersection between the RF axis (revolution axis which is the z-axis) of the antenna and the mounting plate.

Mechanical Doris antenna frame origin in KMSF				
		X (mm)	Y (mm)	Z (mm)
Mechanical Doris antenna frame origin in KMSF		0.1889	544.0537	2466.7336
DORIS antenna phase center in antenna ref frame – 400 MHz (source DR9)		0	0	145
DORIS antenna phase center in antenna ref frame – 2 GHz (source DR9)		0	0	311
DORIS antenna phase center in KMSF– 400 MHz		-0.2	544.6	2631.1
DORIS antenna phase center in KMSF – 2 GHz		-0.2	544.6	2797.1
Mechanical Doris antenna frame origin in Sat RF				
		X (mm)	Y (mm)	Z (mm)
Mechanical Doris antenna frame origin in SAT RF		-1	544.3	4638.6

**Table 4-2 Doris antenna reference frame origin**

**Accuracies on Doris-to-CoM vector knowledge**

Next Table gives the status on the expected accuracy on this vector knowledge, based on last preflight measurements.

		Doris center of phase position knowledge in mm								
		static components			Dynamic components Orbital variations shorter			or Dynamic components Long term variations		
		X-axis	Y-axis	Z-axis	X-axis	Y-axis	Z-axis	X-axis	Y-axis	Z-axis
L3b-PL-108	PL knowledge of Doris phase center wrt KMSF	+/- 1,41	+/- 1,80	+/- 1,80	+/- 0,50	+/- 0,50	+/- 0,50	+/- 1,00	+/- 1,30	+/- 1,80
	CBE [Final PL]	+/- 0,00	+/- 1,00	+/- 5,00	+/- 0,00	+/- 0,00	+/- 0,00	+/- 0,00	+/- 1,00	+/- 1,00
L3a-FS-250	CoG knowledge	+/- 6,00	+/- 6,00	+/- 6,00	+/- 1,50	+/- 1,50	+/- 1,50	+/- 4,00	+/- 4,00	+/- 4,00
	CBE [Final]	+/- 2,35	+/- 2,57	+/- 3,16	+/- 0,33	+/- 0,36	+/- 0,55	+/- 3,06	+/- 3,09	+/- 1,73
L3a-FS-252	Vector DORIS-CoG requirement	+/- 10,00	+/- 10,00	+/- 12,00	+/- 5,00	+/- 5,00	+/- 5,00	+/- 5,00	+/- 5,30	+/- 5,80
	<b>CBE</b>	<b>+/- 2,43</b>	<b>+/- 3,13</b>	<b>+/- 8,17</b>	<b>+/- 0,42</b>	<b>+/- 0,41</b>	<b>+/- 0,63</b>	<b>+/- 3,36</b>	<b>+/- 4,19</b>	<b>+/- 2,53</b>
	<b>Margin</b>	<b>75,70%</b>	<b>68,70%</b>	<b>31,90%</b>	<b>91,60%</b>	<b>91,80%</b>	<b>87,40%</b>	<b>32,80%</b>	<b>20,94%</b>	<b>56,38%</b>

**Table 4-3 Accuracies on Doris-to-CoM vector knowledge**

### 4.3.2. Doris antenna phase laws

This is provided in DR9

Azimuth and Elevation Antenna phase laws shall be described according to the phase center defined in previous section.

Variation of phase in elevation:

$\varepsilon$  : maximum difference compared to a law of constant phase  $y(\theta) = K \pm \varepsilon$  ( $K = \text{constant}$ )

Frequency (MHz)		401,250	2036,250
Objective $\varepsilon$ ( $- 56^\circ \leq \theta \leq 56^\circ$ )		$\leq \pm 4^\circ$	$\leq \pm 2^\circ$
$\varepsilon$ obtained values for following values of $\varphi$	$0^\circ$	$\pm 1,4^\circ$	$\pm 3,6^\circ$
	$22,5^\circ$	$\pm 0,7^\circ$	$\pm 2,3^\circ$
	$45^\circ$	$\pm 1,0^\circ$	$\pm 3,1^\circ$
	$67,5^\circ$	$\pm 1,25^\circ$	$\pm 2,8^\circ$
	$90^\circ$	$\pm 1,25^\circ$	$\pm 2,2^\circ$
	$112,5^\circ$	$\pm 1,2^\circ$	$\pm 2,0^\circ$
	$135^\circ$	$\pm 1^\circ$	$\pm 3,0^\circ$
	$157,5^\circ$	$\pm 1,3^\circ$	$\pm 1,9^\circ$

Variation of phase in azimuth:

$\varepsilon$  : maximum difference compared to a law of linear phase  $y(\Phi) = K\Phi \pm \varepsilon$  ( $K = \text{constant}$ )

Frequency (MHz)		401,250	2036,250
Specification $\varepsilon$ ( $- 180^\circ \leq \Phi \leq + 180^\circ$ )		$\leq \pm 4^\circ$	$\leq \pm 2^\circ$
$\varepsilon$ obtained values for following values of $\theta$	$10^\circ$	$\pm 1,2^\circ$	$\pm 1,5^\circ$
	$20^\circ$	$\pm 0,7^\circ$	$\pm 1,6^\circ$
	$30^\circ$	$\pm 0,9^\circ$	$\pm 1,6^\circ$
	$40^\circ$	$\pm 1,6^\circ$	$\pm 3,0^\circ$
	$56^\circ$	$\pm 1,8^\circ$	$\pm 3,4^\circ$
	$60^\circ$	$\pm 2,1^\circ$	$\pm 2,6^\circ$

## 4.4. GPSP PARAMETERS

### 4.4.1. GPSP antenna phase center

Following table gives the position of the mechanical antenna reference frame in KMSF, and the position of the antenna phase center in this antenna ref frame. An adapter plate was attached to the bottom GPSP antenna before being placed on the spacecraft. The antenna reference is at the bottom-center of the antenna between the adapter


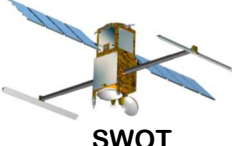
	 <p style="text-align: center;"><b>SWOT</b></p>	Reference : SWOT-NT-SYS-2191-CNES Issue : 1 Date : <b>26/10/2023</b> Page : 37/47
---	---	--

plate and the antenna, 87 mm below the rim cup. This adapter plate has a thickness of 18 mm. The top of this adapter plate (attached to antenna) represents the plane of the antenna reference frame. The bottom of the adapter plate (attached to the spacecraft) is +53 mm along the +Z axis of the observatory coordinate system. As such, the position of the antenna reference point is +35 mm along the +Z axis of the observatory coordinate system.

GPSP antenna phase center in GPSP antenna RF				
		X (mm)	Y (mm)	Z (mm)
GPSP antenna phase center in antenna ref frame – L1		-0.832	-0.365	100.460
GPSP antenna phase center in antenna ref frame – L2		-0.532	-0.413	105.472
GPSP antenna phase center in antenna ref frame – LC		-1.295	-0.291	92.713

**Table 4-4 GPSP antenna phase center in antenna reference frame**

Document DR13 provides Nominal transfer matrices (Translation & Rotation) from sat reference frame to pod reference frame.

Relative Positions of Relevant Frames in KMSF			
	X (mm)	Y (mm)	Z (mm)
Observatory coordinate system	1.167	-0.162	-2171.861
GPSP antenna reference point	1.167	-0.162	-2136.861

**Table 4-5 GPSP antenna reference in KMSF: position**

The orientation of the antenna reference frame with respect to the observatory system is as follows:

	$X_s$	$Y_s$	$Z_s$
$X_{GPS}$	$-\sin(30^\circ)$	$\cos(30^\circ)$	0.000
$Y_{GPS}$	$\cos(30^\circ)$	$\sin(30^\circ)$	0.000
$Z_{GPS}$	0.000	0.000	-1.000

The orientation of the antenna reference frame with respect to the KMSF is then as follows:

	$X_{KMSF}$	$Y_{KMSF}$	$Z_{KMSF}$
$X_{GPS}$	-0.499892905956	0.866087126916	0.000413720858
$Y_{GPS}$	0.866087171193	0.499892986966	-0.000116087313
$Z_{GPS}$	-0.000307357883	0.000300287103	-0.999999907679

**Table 4-6 GPSP antenna reference in KMSF : orientation**

**Accuracies on GPSP-to-CoM vector knowledge**

Next Table gives the requirements at PL and CoG level, and the required values on the vector.

		GPSP phase center position knowledge in mm								
		static components			Dynamic components			Dynamic components		
		X-axis	Y-axis	Z-axis	Orbital variations or shorter			Long term variations		
		X-axis	Y-axis	Z-axis	X-axis	Y-axis	Z-axis	X-axis	Y-axis	Z-axis
L3b-PL-109 => GPSP-101	On orbit position of L4-phase center wrt S/C mounting plane	+/- 6,00	+/- 6,00	+/- 6,00	+/- 0,00	+/- 0,00	+/- 0,00	+/- 0,00	+/- 0,00	+/- 0,00
	CBE [Final PL]	+/- 3,92	+/- 3,92	+/- 3,92	+/- 0,00	+/- 0,00	+/- 0,00	+/- 0,00	+/- 0,00	+/- 0,00
SWOT-PFPLIF103-REQ-0388	Instrument mounting alignment uncertainty is for static part	+/- 1,00	+/- 1,00	+/- 1,00	+/- 0,00	+/- 0,00	+/- 0,00	+/- 0,00	+/- 0,00	+/- 0,00
	CBE [Final]	+/- 0,77	+/- 0,77	+/- 0,19	+/- 0,00	+/- 0,00	+/- 0,00	+/- 0,00	+/- 0,00	+/- 0,00
SWOT-SAT-REQ-2350	Thermoelastic : from GPSP ref frame to SC/PL IF	+/- 0,00	+/- 0,00	+/- 0,00	+/- 1,50	+/- 1,50	+/- 1,50	+/- 0,00	+/- 0,00	+/- 0,00
	CBE [Final]	+/- 0,00	+/- 0,00	+/- 0,00	+/- 0,10	+/- 0,18	+/- 0,99	+/- 0,00	+/- 0,00	+/- 0,00
	Pointing error impact	+/- 0,00	+/- 0,00	+/- 0,00	+/- 0,50	+/- 0,50	+/- 0,50	+/- 0,00	+/- 0,00	+/- 0,00
SWOT-PFPLIF103-REQ-4611	SC/PL Interface to KaRIn Metering Structure Frame	+/- 0,125	+/- 0,125	+/- 0,125	+/- 0,125	+/- 0,125	+/- 0,125	+/- 0,125	+/- 0,125	+/- 0,125
	CBE [Final PL]	-0,004	0,084	0,043	0,011	0,011	0,005	0,024	0,061	0,150
L3a-FS-457	Knowledge of GPSP phase center wrt KMSF	+/- 6,10	+/- 6,10	+/- 6,10	+/- 1,70	+/- 1,70	+/- 1,70	+/- 0,15	+/- 0,15	+/- 0,15
	Budget : on-orbit center of phase wrt PL ref. frame => RMS addition of independant contributors	+/- 3,99	+/- 4,00	+/- 3,92	+/- 0,51	+/- 0,53	+/- 1,11	+/- 0,02	+/- 0,06	+/- 0,15
L3a-FS-250	CoG knowledge	+/- 6,00	+/- 6,00	+/- 6,00	+/- 1,50	+/- 1,50	+/- 1,50	+/- 4,00	+/- 4,00	+/- 4,00
	CBE [Final]	+/- 2,35	+/- 2,57	+/- 3,16	+/- 0,33	+/- 0,36	+/- 0,55	+/- 3,06	+/- 3,09	+/- 1,73
L3a-FS-253	Vector GPSP-CoG req	+/- 12,10	+/- 12,10	+/- 12,10	+/- 5,00	+/- 5,00	+/- 5,00	+/- 5,00	+/- 5,00	+/- 5,00
	<b>CBE</b>	+/- 6,34	+/- 6,57	+/- 7,08	+/- 0,84	+/- 0,89	+/- 1,66	+/- 3,08	+/- 3,15	+/- 1,88
	<b>Margin</b>	<b>47.6%</b>	<b>45.7%</b>	<b>41.45%</b>	<b>83.2%</b>	<b>82.17%</b>	<b>66.82%</b>	<b>38.3%</b>	<b>37%</b>	<b>62.4%</b>

**Table 4-7 Accuracies on GPSP-to-CoM vector knowledge**

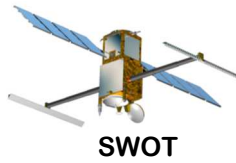
**4.4.2. GPSP phase law**

The antenna calibrations for the antenna are provided in a compressed folder named 9\_P-1259682-RSE\_1\_PFM\_049.zip. The folder contains:

All information contained in this document are proprietary to CNES and shall be treated as such by the recipient party.

It shall not be used for any purpose other than the use of SWOT and shall not, in whole or in part be reproduced, communicated or copied in any form or by any means (electronically, mechanically, photocopying, recording, or otherwise) to any person without prior written permission from CNES.





Reference : SWOT-NT-SYS-2191-CNES  
Issue : 1  
Date : 26/10/2023  
Page : 39/47

1. A file named "Grasp\_format.txt" that describes the format of the antenna calibration files as provided by RUAG.
2. A file named Readme\_049.txt that provides the location that was used to measure the antenna calibration relative to the antenna reference frame. Here, we refer to the origin of the antenna reference frame as the antenna reference point (ARP). The ARP, as defined by RUAG, is the bottom-center of the antenna as delivered. The position used to measure the antenna calibrations is effectively the top of the rim cup of the antenna, which has coordinates of (0,0,87) mm with respect to the ARP.
3. A folder named GraspFiles\_RF contains the antenna calibrations at 36 different frequencies as a function of elevation and azimuth.

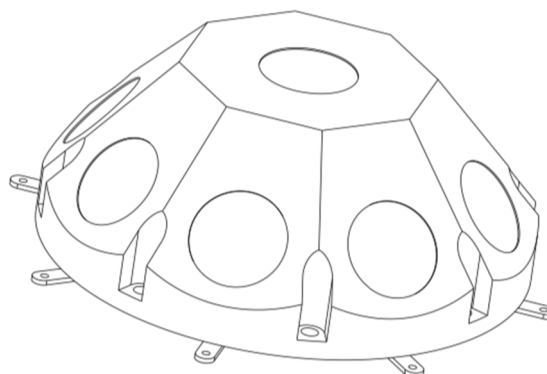
These files have been provided to CNES. The antenna phase center locations provided in section 4.4.1 have been determined using a best fit sphere to the calibration measurements provided in this file. Values in these files are with respect to the rim cup, and phase center offsets in the table provided in section 4.4.1 are with respect to the antenna reference point (i.e., values in table account for 87 mm difference between rim cup and antenna reference.)

## 4.5. LRA PARAMETERS

### 4.5.1. LRA optical center


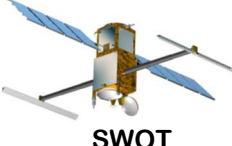
Satellite laser ranging measurements from the SWOT mission are used to support precise orbit determination of the satellite, and/or validation of precise orbit determination performed using other tracking systems (e.g., GNSS, DORIS). The International Laser Ranging Service (<https://ilrs.cddis.eosdis.nasa.gov>), a service of the International Association of Geodesy, coordinates activities for the international network of laser ranging field stations, with the network representing a global consortium of permanent and mobile field stations. The ILRS collects and distributes laser ranging measurements from the network to the passive Laser Retroreflector Array (LRA) on SWOT.

The LRA onboard SWOT is manufactured by ITE Inc. and is a copy of those flown on the Jason-2, Jason-3, and SWOT missions. It has 9 cubes on a spherical surface, as shown in Figure 1. The cubes are manufactured from SUPRASIL-1 (quartz) and have a diameter of approximately 32 mm. They have a refractive index of 1.46071 for a wavelength of 0.532 microns, and a group refractive index of 1.4853 for a wavelength of 0.532 microns. Nominally, no obscuration of the cubes can occur, but they can be obscured by MLI at very high off-nadir angle measurements. The back-face coating material is MgF<sub>2</sub>.



Isometric view

Figure 4-2 SWOT LRA

	 <p style="text-align: center;"><b>SWOT</b></p>	Reference : SWOT-NT-SYS-2191-CNES Issue : 1 Date : <b>26/10/2023</b> Page : 40/47
---	---	--

The position of the origin of the LRA reference frame in the KaRIn Metering Structure Frame (KMSF) is provided in Table 4-8, both from the Mechanical Interface Control Document and as measured. The origin of the LRA reference frame is located at the baseplate of the LRA, with the X and Y axes lying in the plane of the baseplate. The Z-axis of the LRA reference frame effectively points outward to the top-facing cube. The positions reported in Table 1 account for the thickness of the LRA bracket and the LRA washers. The orientation of the LRA in the KMSF is provided in Table 4-9. The optical center of the LRA in the LRA reference frame is provided in Table 4-10. The location and orientation of the individual cubes in the LRA are provided in Table 4-11.

Mechanical LRA antenna frame origin in KMSF				
		X (mm)	Y (mm)	Z (mm)
Mechanical Interface Control Drawing		0	-544.921	2414.529
Measured		-1.9025	-546.0446	2412.7247

**Table 4-8 Position of origin of LRA reference frame in the KaRIn Metering Structure Frame (KMSF). Units are mm.**

	X <sub>s</sub>	Y <sub>s</sub>	Z <sub>s</sub>
Mechanical Interface Control Drawing			
X <sub>LRA</sub>	1.000	0.000	0.000
Y <sub>LRA</sub>	0.000	1.000	0.000
Z <sub>LRA</sub>	0.000	0.000	1.000
Measured Values			
X <sub>LRA</sub>	1.000000	0.000002	0.000923
Y <sub>LRA</sub>	-0.000003	1.000000	0.000663
Z <sub>LRA</sub>	-0.000923	-0.000663	0.999999

**Table 4-9 Orientation of the LRA in the KaRIn Metering Structure Frame.**

X <sub>LRA</sub>	Y <sub>LRA</sub>	Z <sub>LRA</sub>
0.0	0.0	-23.375

**Table 4-10 Position of LRA optical center in the LRA reference frame. Units are mm.**

## 4.6. OPTICAL CORRECTION

Note that a range correction to the measured range is required to move the point of optical reflection to the optical center of the LRA. The optical center defined in Figure 4-3 is the center of a sphere on which the front faces of the retroreflector cubes are tangent. Range corrections are also shown in the figure, representing the error window for a given line of sight or incidence angle ( $\theta, \phi$ ) on the array. Adding the range correction to the measured range adjusts the apparent point of reflection to the optical center of the retroreflector array. Alternatively, and if desired, the incidence angle dependence could be removed by using instead an average range correction of 4.6 cm across the entire array.

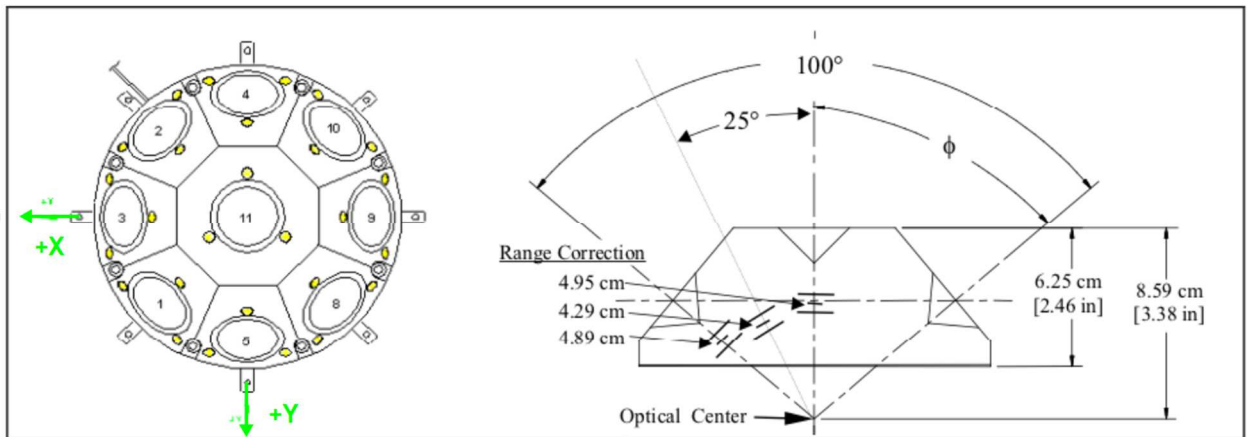
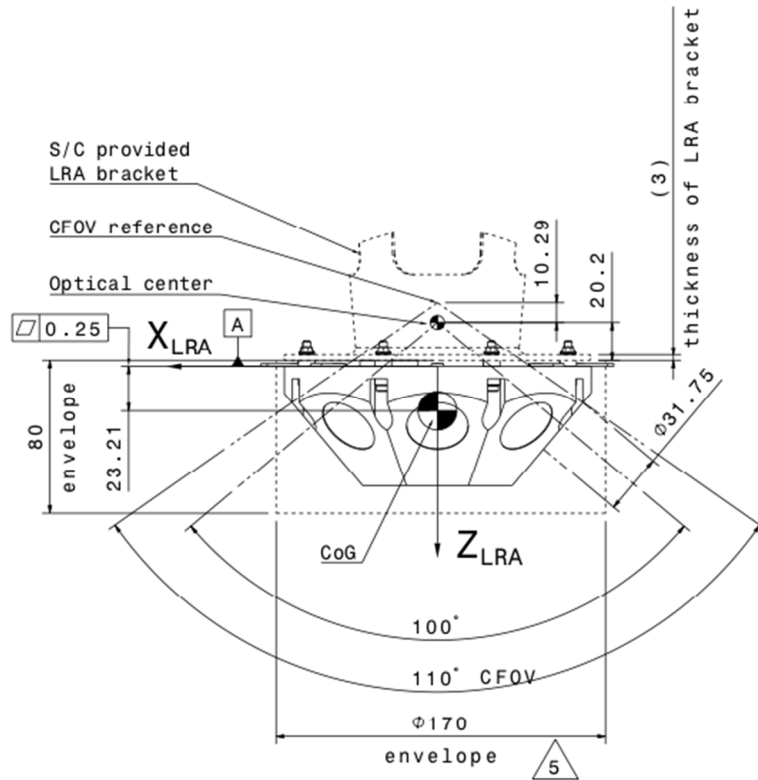


Figure 4-3 LRA field of view (FOV) and coordinate system. The Z-axis of the LRA reference frame points toward nadir.

Cube SN	X	Y	Z	$\theta$	$\phi$
3	0.06324	0.00000	0.05306	0.00000	0.87266
1	0.04472	0.04472	0.05306	0.78540	0.87266
5	0.00000	0.06324	0.05306	1.57080	0.87266
8	-0.04472	0.04472	0.05306	2.35619	0.87266
9	-0.06324	0.00000	0.05306	3.14159	0.87266
10	-0.04472	-0.04472	0.05306	3.92699	0.87266
4	0.00000	-0.06324	0.05306	4.71239	0.87266
2	0.04472	-0.04472	0.05306	5.49779	0.87266
11	0.00000	0.00000	0.08255	0.00000	0.00000

**Table 4-11 Retroreflector Array Coordinates. Units are m and radians.**

## 4.7. ACCURACIES ON LRA-TO-COM VECTOR KNOWLEDGE


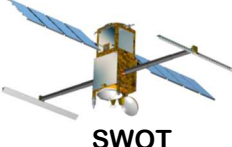
Next Table gives the requirements at PL and CoG level, and the required values on the vector.

		LRA optical center position knowledge								
		static components			Dynamic components Orbital variations or shorter			Dynamic components Long term variations		
		X-axis	Y-axis	Z-axis	X-axis	Y-axis	Z-axis	X-axis	Y-axis	Z-axis
L3b-PL-110	PL knowledge of LRA optical center wrt KMSF	+/- 1,41	+/- 1,80	+/- 1,80	+/- 0,50	+/- 0,50	+/- 0,50	+/- 1,00	+/- 1,30	+/- 1,80
	CBE [Final PL]	+/- 0,20	+/- 0,76	+/- 0,20	+/- 0,10	+/- 0,10	+/- 0,10	+/- 0,20	+/- 0,40	+/- 1,40
L3a-FS-250	CoG knowledge	+/- 6,00	+/- 6,00	+/- 6,00	+/- 1,50	+/- 1,50	+/- 1,50	+/- 4,00	+/- 4,00	+/- 4,00
	CBE [Final]	+/- 2,35	+/- 2,57	+/- 3,16	+/- 0,33	+/- 0,36	+/- 0,55	+/- 3,06	+/- 3,09	+/- 1,73
L3a-FS-254	Vector LRA-CoG requirement	+/- 10,00	+/- 10,00	+/- 12,00	+/- 5,00	+/- 5,00	+/- 5,00	+/- 5,00	+/- 5,30	+/- 5,80
	<b>CBE</b>	<b>+/- 2,55</b>	<b>+/- 3,33</b>	<b>+/- 3,36</b>	<b>+/- 0,43</b>	<b>+/- 0,46</b>	<b>+/- 0,65</b>	<b>+/- 3,26</b>	<b>+/- 3,49</b>	<b>+/- 3,13</b>
	Margin	74,53%	66,69%	72,03%	91,40%	90,80%	87,00%	34,80%	34,15%	46,03%

**Table 4-12 Accuracies on LRA-to-CoM vector knowledge**

## 4.8. POSEIDON-3C PARAMETERS

To process the nadir altimeter data, it is necessary to know precisely the position of the measurement reference at antenna level.

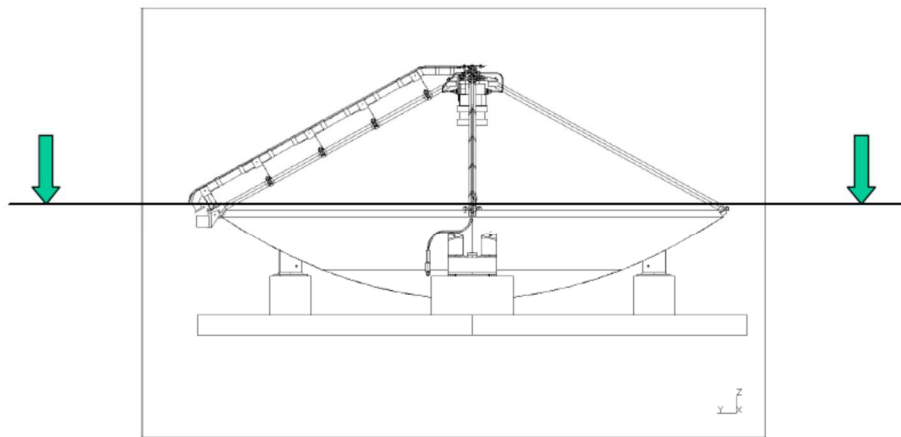
	 <b>SWOT</b>	Reference : SWOT-NT-SYS-2191-CNES
		Issue : 1
		Date : <b>26/10/2023</b>
		Page : 43/47

Mechanical nadir altimeter antenna frame origin in KMSF			
	X (mm)	Y (mm)	Z (mm)
Mechanical NA top of the POD in KMSF (PL)	-567.4	-0.6	2072.5
<i>Mechanical NA reference frame in KMSF (PL level) – cube reference, for reference only</i>	-670.666	667.644	2227.853

Rotation	XKMSF	YKMSF	ZKMSF
<b>XANT</b>	0,999999987290	0,000147709343	-0,000060018928
<b>YANT</b>	-0,000147766095	0,999999540985	-0,000946676220
<b>ZANT</b>	0,000059879067	0,000946685077	0,999999550101

**Table 4-13 Nadir altimeter antenna reference frame position and rotation in KMSF**

For POS3C antenna phase center, we use a virtual reference plan which is located between the antenna mechanical reference point and the feed.



**Figure 4-4 Pos3C antenna reference plan definition**


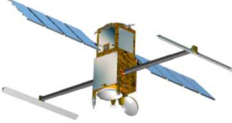
The coordinates of the antenna reference plan with reference to the antenna *mechanical* reference frame is (only Z axis is used) :

X (mm)	Y (mm)	Z (mm)
0	0	209.302

Accounting on the supporting columns heights in addition we end up with the following Z coordinates:

Pos3C antenna reference plan in KMSF					
X (mm)	Y (mm)	Z (mm)	X (mm)	Y (mm)	Z (mm)
-567,40 mm	-0,60 mm	2256,50 mm	-568,57 mm	-0,44 mm	4428,36 mm

**Table 4-14 Nadir altimeter measurement reference position in KMSF**

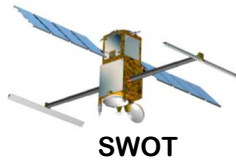
	 <p style="text-align: center;"><b>SWOT</b></p>	Reference : SWOT-NT-SYS-2191-CNES Issue : 1 Date : <b>26/10/2023</b> Page : 44/47
--	---	--

Initial distance in Z axis between antenna reference plan and satellite center of mass is : 2846.6 mm

Accuracy :

L3a-FS-458 – Radial Error - NA Phase Center to FS CoM: The Observatory shall know the variations of the radial position of the Nadir Altimeter phase center with respect to the Observatory Center of Mass to within 5.5 mm (3-sigma)

Contribution	Requirement	CBE
L3b-PL-263 POS-3C baseline center stability	3,8 (1 sigma)	1,55 mm (1 sigma)
L3a-FS-250 F/S CoM knowledge error	4,3 mm	1,4 mm
<b>L3a-FS-458</b>	<b>5,5 mm</b>	<b>2,9 mm</b>



Reference : SWOT-NT-SYS-2191-CNES  
Issue : 1  
Date : 26/10/2023  
Page : 45/47

## DISTRIBUTION

CNES		Entity
MANFREDI Cécile	X	DOA/OT/DOR
DUMOND Olivier	X	DOA/OT/DOR
BUZON Pierre	X	DOA/OT/DOR
CHAUVEAU Jean-Pierre	X	DOA/OT/DOR
PERELMUTER Philippe	X	DOA/OT/DOR
PICOT Nicolas	X	DOA/OT/OH
SENGENES Pierre	X	DOA/OT/SWO
TELLO Magali	X	DOA/OT/SWO
REDONDO Rocio	X	DOA/OT/SWO
STEUNOU Nathalie	X	DOA/OT/SWO
RAFFIER Bertrand	X	DTN/DV/AS
GUERIN Alexandre	X	DTN/TPI/INR
COUHERT Alexandre	X	DTN/DV/OR
MERCIER Flavien	X	DTN/DV/OR
HOURY Sabine	X	DTN/DV/OR
MARECHAL Christophe	X	DOA/MDA/OT
BIGNALET François	X	DOA/MDA/OT
DIDELOT François	X	DOA/MDA/OT
JPL		Entity
DESAI Shailen	X	
TUNG Ramona	X	
CRUZ Jennifer	X	
KAKI Said	X	